



RHE20 Desktop Reference



Rheonik Messtechnik GmbH
Rudolf-Diesel-Straße 5
D-85235 Odelzhausen
Germany

Tel + 49 (0)8134 9341-0
info@rheonik.com

LEARN
MORE



Document No.: 8.2.1.01
Version 2.42
December 2021

RHE 20

Transmitter

Desktop Reference

RHEONIK.

Table of Contents

1 Introduction.....	13
1.1 Welcome.....	13
1.2 System overview.....	13
1.3 Scope and Contents of the Manual	14
1.4 Safe Operation and Liability.....	14
1.5 USB Service Port for Configuration.....	15
1.6 RS485 Interface Electrical Characteristics, MODBUS Protocol.....	15
1.7 Zeroing Procedure	16
1.8 Flow Meter Calibration.....	17
1.8.1 Mass Flow K-Factor	18
1.8.2 Calibration Procedure.....	18
1.8.3 Calibration Support	19
2 RHEComPro Suite for Transmitter Configuration and Operation	21
2.1 RHEComPro Suite Software Installation, License Handling, and First Steps	21
2.2 MODBUS Protocol Interface	21
2.2.1 Communications Interfaces.....	21
2.2.2 MODBUS Commands Implemented in the RHE Transmitter.....	22
2.2.3 MODBUS Register Access	22
2.2.4 Notes on the 32-bit Floating Point Precision.....	23
2.2.5 Access Level.....	23
2.2.6 Modifying Setup Parameters.....	24
2.2.7 Fast Access to Important Data	25
3 RHE20 Transmitter HMI Capabilities.....	26
3.1 Input Buttons.....	26
3.2 Presentation Screens	27
3.3 Menu Structure and Navigation.....	28
3.4 Data Display	30
3.4.1 Measurement Values	30
3.4.2 Bitset Status Information	30
3.5 Data Input.....	31
3.5.1 Input of Floating Point Numbers	32
3.5.2 Input of Choices	33
3.5.3 Save Setup or Discard Changes	33
3.6 Special Functions	34

3.6.1	<i>Passcode Login</i>	34
3.6.2	<i>Zeroing Start</i>	35
3.6.3	<i>Status and Assurance View Screens</i>	35
3.6.4	<i>OIML / Custody Transfer Information</i>	35
4	<i>RHE Transmitter Configuration</i>	37
4.1	<i>Unit Handling</i>	37
4.2	<i>Mass Flow Rate Parameter Setup</i>	39
4.2.1	<i>Flow Direction</i>	39
4.2.2	<i>Cut Off Limit</i>	39
4.2.3	<i>Max/Min Mass Flow Warning Limits</i>	40
4.2.4	<i>Mass Flow Filter Setting, Damping</i>	41
4.3	<i>Density Parameter Setup and Calculation</i>	42
4.3.1	<i>Max/Min Density Warning Limits</i>	44
4.3.2	<i>API Standard Density</i>	44
4.4	<i>Volumetric Flow Rate Parameter Setup</i>	45
4.4.1	<i>Max/Min Volumetric Flow Warning Limits</i>	46
4.5	<i>Totalizer Handling</i>	46
4.5.1	<i>Max Totalized Flow Warning Limits</i>	47
4.6	<i>Temperature Measurement Parameters</i>	47
4.6.1	<i>Max/Min Temperature Warning Limits</i>	47
4.7	<i>Pressure Management</i>	48
4.8	<i>Digital Output Setup</i>	48
4.8.1	<i>Alarm Outputs 3 and 4, A and B</i>	50
4.8.2	<i>Versatile Pulse/Frequency Outputs 1 and 2</i>	51
4.8.2.1	<i>Pulse Width and Pulse Frequency Limit</i>	52
4.8.2.2	<i>Versatile Outputs 1 and 2 as Pulse Outputs</i>	53
4.8.2.3	<i>Slow Pulse Mode</i>	55
4.8.2.4	<i>Testing a Pulse Transmission Link</i>	55
4.8.2.5	<i>Versatile Outputs 1 and 2 as Frequency Outputs</i>	56
4.8.3	<i>Test Modes for the Digital Outputs</i>	58
4.8.4	<i>Test Modes for the Versatile Digital Outputs</i>	58
4.8.5	<i>Notes on the Pulse / Frequency Outputs</i>	58
4.9	<i>Current Output Setup</i>	59
4.9.1	<i>Modes of the Current Output</i>	60
4.9.2	<i>Setting Measurement Range</i>	60
4.9.3	<i>Error Condition/Fire State Setting</i>	61
4.9.4	<i>Fast Current Output Configuration</i>	61

4.9.5	<i>Output Damping</i>	61
4.9.6	<i>PID Controller</i>	62
4.9.7	<i>Tests and Calibration</i>	62
4.10	<i>Analog Inputs, Pressure, Density, or External Temperature Measurement</i>	63
4.10.1	<i>Calibration of the Analog Input</i>	63
4.10.2	<i>Parameterization for Pressure Input</i>	64
4.10.3	<i>Parameterization for Density Input</i>	66
4.10.4	<i>Parameterization for External Temperature</i>	67
4.11	<i>Digital Inputs</i>	67
4.12	<i>Batch Filling Mode</i>	69
4.12.1	<i>Simple Batch Filling Configurations</i>	70
4.12.2	<i>Automatic Filling Support</i>	71
4.12.3	<i>Additional Batch-Related Functionality</i>	72
4.13	<i>Drive Control</i>	74
4.14	<i>Hardware Lock Switch / Custody Transfer Lock</i>	75
4.15	<i>Special Density Calculations</i>	76
4.15.1	<i>API MPMS Density Calculation (Modes 1 to 3)</i>	77
4.15.2	<i>Net Oil Calculation (Mode 4)</i>	77
4.15.3	<i>Percent Substance Calculation (Mode 5)</i>	78
4.15.4	<i>Percent Substance Calculation (Mode 7)</i>	78
4.16	<i>Partly Filled Pipe Management</i>	79
5	<i>HART® Protocol Interface</i>	81
6	<i>Troubleshooting</i>	82
6.1	<i>Failure Causes and Consequences</i>	82
6.2	<i>LED Status Indicator Description</i>	84
6.3	<i>MODBUS Status Register Description</i>	84
6.3.1	<i>ErrorStatus Register</i>	85
6.3.2	<i>SoftError Register</i>	86
6.3.3	<i>Warnings Register</i>	86
6.3.4	<i>InfoStatus Register</i>	87
6.4	<i>Problem Solving</i>	88
6.4.1	<i>Pulse/Frequency or Digital Outputs Not Working</i>	88
6.4.2	<i>Current Output Not Working</i>	88
6.4.3	<i>Red Error LED is ON</i>	89
6.4.3.1	<i>SoftError, Bit 4: Torsion Bar Temperature Reading Error</i>	89
6.4.3.2	<i>SoftError, Bit 3: Tube Temperature Reading Error</i>	90
6.4.3.3	<i>SoftError, Bit 22: Sensor not (yet) ready</i>	90

6.4.4	<i>The Green LED is Off</i>	91
6.5	<i>Important Notes on Returning Equipment to the Factory</i>	91
Appendix A	<i>The Coriolis Principle</i>	93
Appendix B	<i>Transmitter Maintenance</i>	94
B.1	<i>Passcode Calculator</i>	94
B.2	<i>Density Calibration</i>	94
B.3	<i>Simple Density Field Calibration</i>	97
Appendix C	<i>HMI Menu Structure</i>	99
C.1	<i>Assurance View</i>	101
C.2	<i>Status Infos</i>	101
C.3	<i>Quick Setup</i>	102
C.4	<i>Batch Operation</i>	103
C.5	<i>Measurement View</i>	104
C.6	<i>Diagnostics</i>	105
C.7	<i>User Login</i>	106
C.8	<i>Service Login</i>	108
Appendix D	<i>MODBUS Register Map</i>	110
D.1	<i>Mass Flow Rate</i>	110
D.1.1	<i>Mass Flow Rate – MODBUS Holding Registers</i>	111
D.1.1.1	<i>Mass Flow Rate – MODBUS Holding Registers, USER Level</i>	111
D.1.1.2	<i>Mass Flow Rate – MODBUS Holding Registers, SERVICE Level</i>	111
D.1.2	<i>Mass Flow Rate – MODBUS Input Registers</i>	117
D.1.2.1	<i>Mass Flow Rate – MODBUS Input Registers, USER Level</i>	117
D.2	<i>Volumetric Flow Rate</i>	117
D.2.1	<i>Volumetric Flow Rate – MODBUS Holding Registers</i>	118
D.2.1.1	<i>Volumetric Flow Rate – MODBUS Holding Registers, USER Level</i>	118
D.2.1.2	<i>Volumetric Flow Rate – MODBUS Holding Registers, SERVICE Level</i>	119
D.2.2	<i>Volumetric Flow Rate – MODBUS Input Registers</i>	119
D.2.2.1	<i>Volumetric Flow Rate – MODBUS Input Registers, USER Level</i>	119
D.3	<i>Density Measurement and Calculation</i>	120
D.3.1	<i>Density Calculation – MODBUS Holding Registers</i>	120
D.3.1.1	<i>Density Calculation – MODBUS Holding Registers, USER Level</i>	120
D.3.1.2	<i>Density Calculation – MODBUS Holding Registers, SERVICE Level</i>	123
D.3.2	<i>Density Calculation – MODBUS Input Registers</i>	126
D.3.2.1	<i>Density Calculation – MODBUS Input Registers, USER Level</i>	126
D.4	<i>Amplitude Diagnostic</i>	128
D.4.1	<i>Amplitude Diagnostic – MODBUS Holding Registers</i>	128

D.4.1.1	Amplitude Diagnostic – MODBUS Holding Registers, SERVICE Level	128
D.4.2	Amplitude Diagnostic – MODBUS Input Registers	130
D.4.2.1	Amplitude Diagnostic – MODBUS Input Registers, SERVICE Level	130
D.5	Frequency Measurement	130
D.5.1	Frequency Measurement – MODBUS Holding Registers	131
D.5.1.1	Frequency Measurement – MODBUS Holding Registers, SERVICE Level	131
D.5.2	Frequency Measurement – MODBUS Input Registers	132
D.5.2.1	Frequency Measurement – MODBUS Input Registers, USER Level	132
D.5.2.2	Frequency Measurement – MODBUS Input Registers, SERVICE Level	132
D.6	Phase Measurement	132
D.6.1	Phase Measurement – MODBUS Holding Registers	133
D.6.1.1	Phase Measurement – MODBUS Holding Registers, USER Level	133
D.6.1.2	Phase Measurement – MODBUS Holding Registers, SERVICE Level	134
D.6.2	Phase Measurement – MODBUS Input Registers	135
D.6.2.1	Phase Measurement – MODBUS Input Registers, USER Level	135
D.6.2.2	Phase Measurement – MODBUS Input Registers, SERVICE Level	135
D.7	Temperature Measurement	136
D.7.1	Temperature Measurement – MODBUS Holding Registers	136
D.7.1.1	Temperature Measurement – MODBUS Holding Registers, SERVICE Level	136
D.7.2	Temperature Measurement – MODBUS Input Registers	139
D.7.2.1	Temperature Measurement – MODBUS Input Registers, USER Level	139
D.7.2.2	Temperature Measurement – MODBUS Input Registers, SERVICE Level	139
D.8	Pressure Management	140
D.8.1	Pressure – MODBUS Holding Registers	140
D.8.1.1	Pressure – MODBUS Holding Registers, USER Level	140
D.8.2	Pressure – MODBUS Input Registers	144
D.8.2.1	Pressure – MODBUS Input Registers, USER Level	144
D.9	Generic	145
D.9.1	Generic – MODBUS Holding Registers	145
D.9.1.1	Generic – MODBUS Holding Registers, USER Level	145
D.9.1.2	Generic – MODBUS Holding Registers, SERVICE Level	146
D.9.1.3	Generic – MODBUS Holding Registers, FACTORY Level	149
D.9.2	Generic – MODBUS Input Registers	150
D.9.2.1	Generic – MODBUS Input Registers, USER Level	150
D.10	Totalizer	155
D.10.1	Totalizer – MODBUS Holding Registers	156
D.10.1.1	Totalizer – MODBUS Holding Registers, USER Level	156

<i>D.10.1.2 Totalizer – MODBUS Holding Registers, SERVICE Level</i>	157
<i>D.10.2 Totalizer – MODBUS Input Registers</i>	157
<i>D.10.2.1 Totalizer – MODBUS Input Registers, USER Level</i>	157
<i>D.11 Zeroing</i>	159
<i>D.11.1 Zeroing – MODBUS Holding Registers</i>	160
<i>D.11.1.1 Zeroing – MODBUS Holding Registers, USER Level</i>	160
<i>D.11.1.2 Zeroing – MODBUS Holding Registers, SERVICE Level</i>	160
<i>D.11.2 Zeroing – MODBUS Input Registers</i>	162
<i>D.11.2.1 Zeroing – MODBUS Input Registers, USER Level</i>	162
<i>D.12 Unit Conversion</i>	162
<i>D.12.1 Unit Conversion – MODBUS Holding Registers</i>	163
<i>D.12.1.1 Unit Conversion – MODBUS Holding Registers, USER Level</i>	163
<i>D.13 Current Output</i>	167
<i>D.13.1 Current Output – MODBUS Holding Registers</i>	168
<i>D.13.1.1 Current Output – MODBUS Holding Registers, USER Level</i>	168
<i>D.13.1.2 Current Output – MODBUS Holding Registers, SERVICE Level</i>	175
<i>D.13.2 Current Output – MODBUS Input Registers</i>	176
<i>D.13.2.1 Current Output – MODBUS Input Registers, USER Level</i>	176
<i>D.14 Digital and Versatile Digital Outputs</i>	177
<i>D.14.1 Versatile Digital Output – MODBUS Holding Registers</i>	178
<i>D.14.1.1 Versatile Digital Output – MODBUS Holding Registers, USER Level</i>	178
<i>D.14.1.2 Versatile Digital Output – MODBUS Holding Registers, SERVICE Level</i>	187
<i>D.14.2 Versatile Digital Output – MODBUS Input Registers</i>	189
<i>D.14.2.1 Versatile Digital Output – MODBUS Input Registers, USER Level</i>	189
<i>D.15 HMI</i>	190
<i>D.15.1 HMI – MODBUS Holding Registers</i>	191
<i>D.15.1.1 HMI – MODBUS Holding Registers, USER Level</i>	191
<i>D.15.1.2 HMI – MODBUS Holding Registers, SERVICE Level</i>	196
<i>D.15.2 HMI – MODBUS Input Registers</i>	197
<i>D.15.2.1 HMI – MODBUS Input Registers, SERVICE Level</i>	197
<i>D.16 Fast Access Groups</i>	198
<i>D.16.1 Fast Access to Combined Measurements</i>	198
<i>D.16.2 Fast Access to Temperature Data</i>	199
<i>D.16.3 Fast Access to Totalizer Data</i>	199

Baseline reference:

Version 1.00 of this document reflects the properties of the RHE20 firmware version 1.67 and later. The corresponding version of the RHECom program is 2.7.3 or later.

Version 1.30 of this document reflects the properties of the RHE20 firmware version 1.68 and later. The corresponding version of the RHECom program is 2.7.4 or later.

Version 1.40 of this document reflects the properties of the RHE20 firmware version 1.76 and later. The corresponding version of the RHECom program is 2.7.9 or later.

Version 1.50 of this document reflects the properties of the RHE20 firmware version 1.78 and later. The corresponding version of the RHECom program is 2.8.1 or later.

Version 1.62 of this document reflects the properties of the RHE20 firmware version 1.80 and later. The corresponding version of the RHECom program is 2.8.1 or later.

Version 1.63 of this document reflects the properties of the RHE20 firmware version 1.81 and later. The corresponding version of the RHECom program is 2.8.6 or later.

Version 1.64 of this document reflects the properties of the RHE20 firmware version 1.82 and later. The corresponding version of the RHECom program is 2.8.7 or later.

Version 1.66 of this document reflects the properties of the RHE20 firmware version 2.00 and later. The corresponding version of the RHEComPro program is 3.0.6 or later.

Version 1.68 of this document reflects the properties of the RHE20 firmware version 2.02 and later. The corresponding version of the RHEComPro program is 3.0.8 or later.

Version 1.70 of this document reflects the properties of the RHE20 firmware version 2.06 and later. The corresponding version of the RHEComPro program is 3.1.1 or later.

Version 1.80 of this document reflects the properties of the RHE20 firmware version 2.07 and later. The corresponding version of the RHEComPro program is 3.1.4 or later.

Version 2.10 of this document reflects the properties of the RHE20 firmware version 2.09 and later. The corresponding version of the RHEComPro program is 3.1.5 or later.

Version 2.17 of this document reflects the properties of the RHE20 firmware version 2.17 and later. The corresponding version of the RHEComPro program is 3.2.4 or later.

Version 2.30 of this document reflects the properties of the RHE20 firmware version 2.30 and later. The corresponding version of the RHEComPro program is 3.3.0 or later.

Version 2.40 of this document reflects the properties of the RHE20 firmware version 2.40 and later. The corresponding version of the RHEComPro program is 3.4.0 or later.

Version 2.42 of this document reflects the properties of the RHE20 firmware version 2.42 and later. The corresponding version of the RHEComPro program is 3.4.0 or later.

1 Introduction

Thank you for purchasing Rheonik products. Rheonik has more than 20 years of experience in the field of Coriolis mass flow meter design and development. After the exhaustive testing of many different designs, the Omega tube meter with torsion rods and mass bars was granted a patent based upon its unique operation and construction features. Compared to other meter designs, the Rheonik Omega tube design offers outstanding performance and mechanical reliability.

1.1 Welcome

The Coriolis Effect was discovered by the physicist Gustave Gaspard de Coriolis during the 1830s, and is described as “the inertial force exerted on an object as a result of movement relative to a rotating frame of reference.” This science has been applied to many technologies: hydraulics, machine performance, missiles, ergonomics, ocean and atmospheric circulation and, of course, mass flow metering.

The use of the Coriolis Effect as a technique for liquid and gas mass flow measurement was firmly established over 20 years ago. Since then, a number of different designs have been produced.

With the tremendous advances made in electronic signal processing technology in recent years, Coriolis mass flow meters have become highly accurate and reliable instruments.

1.2 System overview

The Coriolis principle is applied to mass flow meters through a variety of different designs, but they all operate using the same “deflection” principle.

The RHE transmitter powers an electromagnetic drive system within the flow meter body that causes the meter tubes to vibrate at their natural or resonant frequency. When liquid or gas flows through these vibrating tubes, additional deflection occurs relative to the inertia of the flowing fluid. This additional deflection is measured electronically by two velocity sensors. The degree of deflection is directly proportional to the mass flow rate of the fluid within the tubes. The measured deflection is converted into physical units digitally using signal processing within the transmitter.

The RHE transmitter has built in diagnostic functions that constantly monitor the performance of the meter. Any disruptions are displayed immediately via LED status signals on the RHE transmitter front panel and other error indications depending on the state of the HMI.

Depending on the type, the ordered options, and the user configuration an RHE20 series transmitter has

- serial RS485 and USB interfaces with Modbus protocol support,
- up to two 4 to 20 mA analog outputs with user programmable span;
- a HART® interface at the first 4 to 20mA analog output,
- up to two configurable pulse outputs that supply flow-proportional impulses,
- one 4 to 20mA analog input for the live measurement of pressure or density,
- up to two digital inputs configurable for zeroing or transmitter reset (batch mode),
- a Custody Transfer Lock switch,
- and up to four status outputs (Alarm Conditions, ERROR, Flow direction (+/-)).

The configuration and the use of these interfaces is described in this manual. All RHE20 models can be configured via the USB or RS485 Modbus interface and the RHEComPro program, see section 2.1, or the user-friendly RHE20 HMI (Human Machine Interface) which consists of a 128x64 pixel display, three input buttons, and three status LEDs.

The use of the HMI is described in this manual, as well, see section 3. Please refer to this description when any problem arises during the use of the HMI. It has been kept as simple as possible, but sometimes the installation of complex configurations need several coordinated steps to be achieved.

1.3 Scope and Contents of the Manual

This desktop reference is intended to describe the details of the functionality of the Rheonik Coriolis transmitter of the RHE20 series consisting of the RHE21, RHE22, RHE26, RHE27, and RHE28 transmitters. The terms RHE20 and RHE2X are used interchangeably throughout the documentation. This series consists of a number of different transmitters in different housings and with specific I/O capabilities. However, the basic functionality of these transmitters is identical and is described in this manual.

Since the installation of the transmitters is type-specific there is a separate installation guide for each type. The following table shows the document applicable to the respective RHE transmitters.

Transmitter	Title	Document Number
RHE21	RHE21 Installation & Start-Up Guide	8.2.1.04
RHE22	RHE22 Installation & Start-Up Guide	8.2.1.05
RHE26/27	RHE26/27 Installation & Start-Up Guide	8.2.1.06
RHE28	RHE28 Installation & Start-Up Guide	8.2.1.07

Depending on the type of the transmitter and the ordered options the transmitter features a HART® interface. The description of the HART® interface is kept in a separate document

Title	Document Number
RHE2X/4X HART® Communication Reference Manual	8.2.1.02
Addendum RHE2/4X Desktop Reference PID Control	8.2.1.30

because it would have increased the size of this manual beyond a manageable scope.

An extensive description of the calibration procedures for the I/O interfaces is found in a separate document, as well:

Title	Document Number
RHE2X Calibration of I/O Interfaces	8.2.1.12

The RHEComPro software suite is described in a separate document:

Title	Document Number
RHEComPro Suite User Manual	8.2.1.18

1.4 Safe Operation and Liability



Important safety instructions

The operating conditions for each flow sensor is stated on its serial number plate. These conditions must not be exceeded.

The maximum operating pressure for each flow sensor is listed on its serial number plate. When using piston pumps, ensure that pressure peaks caused through pump operation do not exceed the maximum operating pressure listed.

Where a flow sensor is operated at high temperature, it must be installed with sufficient thermal insulation to ensure that a stable temperature at the process line temperature is maintained.

Avoid thermal shocks to the flow sensor caused by rapid process temperature changes.

Use in applications with abrasive fluids may cause wear over time of the flow sensor's internal tubes, reducing wall thickness and therefore lowering the maximum operating pressure. In applications where abrasive fluid is present, erosion allowances should be assessed by the system designer.

The flow sensor wetted material is listed on the serial number plate. In applications where corrosion is a possibility, we recommend that the wall thickness of the flow tubes be measured from time to time to ensure continued safe operation. The manufacturer assumes no responsibility for the corrosion resistance of the flow sensor with regard to the fluid to be measured.

For flow sensors used in food, beverage or pharmaceutical applications, it is the responsibility of the end user to ensure cleanliness of any flow sensor before use.

These measuring instruments may not be utilized in life-preserving systems used in medical applications, motor vehicles, aircraft, watercraft or the mining industry.



Liability

The manufacturer accepts no liability for damage resulting from improper usage or installation of the flow sensor or transmitter.

The manufacturer accepts no liability for consequential damages or loss of production caused by the use of its products unless expressly and specifically agreed by contract.

1.5 USB Service Port for Configuration

The RHE transmitter has a *mini-USB* port in the front face as a means to quickly connect a PC-type laptop running the RHEComPro software to perform test, configuration, and commissioning tasks. The location and the properties of the mini-USB port are described in the RHE type specific installation manual.

The mini-USB port is not suited for long-term connection in an industrial environment. The RS485 interface should be used for permanent communication with industrial control and supervisory systems.

1.6 RS485 Interface Electrical Characteristics, MODBUS Protocol

For permanent communication purpose in an industrial environment the RHE transmitter offers a two-wire isolated RS485 interface with Modbus communication protocol. Maximum line distance for the RS485 interface is 1200m. The data rate is configurable from 9.6kBaud to 57.6kBaud. Multiple devices with unique Modbus addresses can be connected to the RS485 wire pair. The MODBUS address of the RHE transmitter is configurable in the range of 1 to 247.

The RS485 line should be connected using shielded 18 – 24 AWG (0.82 – 0.2 mm²) cable with a 120-ohm termination at each end of the communications line.

The RHE transmitter features an internal 120-ohm termination resistor. It is located on a circuit board within the RHE transmitter. Its exact location and the terminals for the RS485 wire connection are shown in the RHE type specific installation manual. Normally, the termination switch (and the factory default position) should be set to ON. When more than one device is attached to the RS485 line this switch must be set to OFF for all devices on the line except for those devices at each end of

the line, where the switch must be set to ON. On the rare occasion that communications appears to be intermittent, setting the termination switch to OFF may improve performance.

The Modbus protocol implemented in the RHE transmitter follows the “MODBUS over Serial Line Specification and Implementation Guide V1.02” definition for OSI protocol level 2 and the “MODBUS Application Protocol Specification V1.1b3” for OSI protocol level 7. Further details can be found in section 2.2.

1.7 Zeroing Procedure

Like all Coriolis instruments, the meter may require zeroing from time to time to remove any offset in the measured flow rate.

Zeroing of the meter should be carried out:

- When an RHM flow sensor and/or RHE transmitter has been newly installed.
- Before field or laboratory calibration of the meter.
- During routine maintenance of the meter.

In order to ensure the zero is correctly set in the meter, it is important to ensure that the following conditions are met:



1. The pipes of the RHM flow sensor are completely filled with process fluid.
2. The RHM flow sensor is at or near normal operating temperature.
3. The meter is in a no flow condition. Valves mounted upstream and downstream of the RHM flow sensor (see the respective diagram in installation manual) must be tightly closed.
4. The RHE transmitter is not in an error condition, i.e. the red LED on the transmitter is not illuminated.
5. The RHM flow sensor must stay in the same condition throughout the zeroing procedure.

The Zeroing Procedure can be initiated in one of three ways:

- 1) Via the “Zero Now” option in the “Quick Setup” menu of the HMI. This requires the input of the user password (when not done beforehand) and a confirmation. Please wait for the displayed countdown to finish before beginning other activities. See section 3.6.2 for further details and the left-hand image in Figure 1.
- 2) Through the RHEComPro software (as described in section 2.1) via the USB port on the front cover of the transmitter. The Filter Dashboard window of the RHEComPro software features a virtual button labeled “Zero Sensor” which starts the Zeroing Procedure when clicked. The Zero sensor button on the Filter Dashboard is shown in the right-hand image of Figure 1.
- 3) Through the RS-485 port using Modbus commands. A supervisory control system can be programmed to zero the meter (along with other functions) as part of an overall control scheme.

When the Zeroing Procedure is active, the orange and the red “ERROR” LEDs on the RHE transmitter front panel both blink. In the Filter Dashboard of the RHEComPro software, a countdown to completion is started in the field labeled “Count”. When this counter reaches 0, the Zeroing Procedure is completed. The end of the Zeroing Procedure is indicated on the transmitter front panel. Upon completion of a successful zero procedure, the red “ERROR” LED will be off, the green “SENSOR” light will be on and the orange LED indicate the state of the Custom Transfer Lock switch.

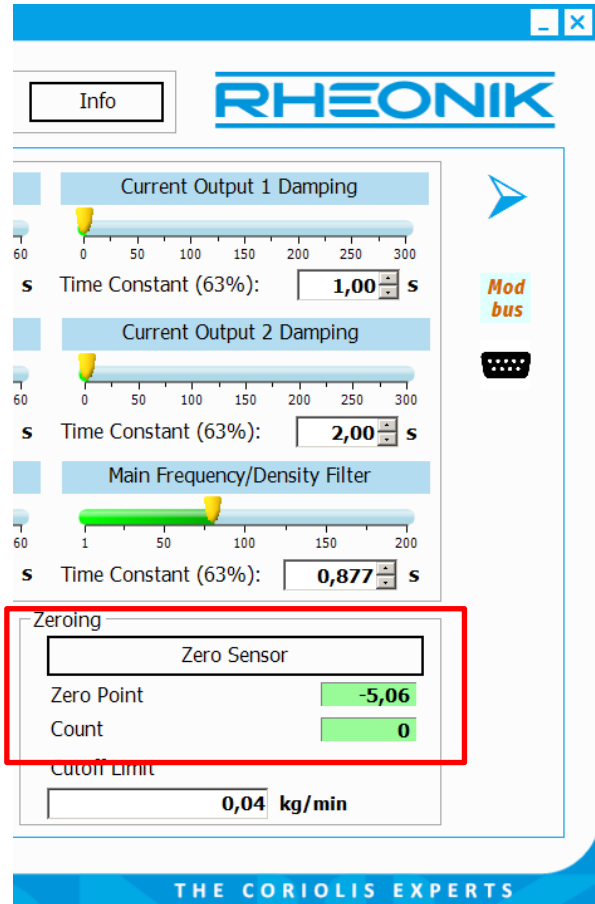
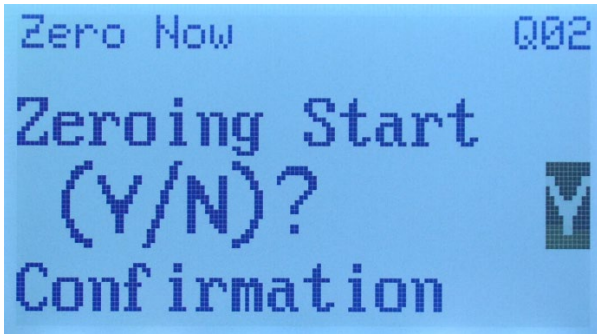



Figure 1: Zeroing Procedure started manually via HMI or using RHEComPro Dashboard

The time taken for the Zeroing Procedure depends upon the oscillation frequency of the RHM flow sensor. In general, zeroing a meter should take approximately 30 seconds.

The result (offset value) of the Zeroing Procedure is displayed in the field labeled “Zero” on the Filter Dashboard of the RHEComPro software and should be a small number. Note that this number is dimensionless and does not relate to flow range or flow units. A number larger than 500 may be a sign of an installation problem or some other issue. The zeroing may be repeated in order to obtain an indication regarding the stability of the installation. The zeroing values should not deviate for more than +/-2 units.

No other configuration activity should be carried out while the zeroing procedure is active as this may reset the RHE transmitter and prematurely terminate the process.

Zeroing of the meter is independent of any meter setup parameters and remains valid even if setup parameters are subsequently modified in the transmitter.

	<p>Once zeroing is complete, the valves upstream and downstream of the RHM flow sensor should be opened.</p> <p><i>Safety first! Ensure this can be done in a safe manner.</i></p>
---	---

1.8 Flow Meter Calibration

All RHE transmitters delivered together with an RHM flow sensor are calibrated at the factory. Meters can be calibrated in the field. This involves comparing meter readings to those of a reference

meter and calculating any error between the two. Once the amount of error is established the RHE transmitter can be adjusted to correct readings to the correct values.

1.8.1 Mass Flow K-Factor

The K-Factor determines the sensitivity of the RHM flow sensor to mass flow and is the key parameter when calibrating a meter. Each individual sensor has a unique K-Factor. The K-Factor value is stored in the setup parameter MassFlowKFactor (0x6922) under the Mass Flow parameter group as described in section 4.2.

1.8.2 Calibration Procedure

The RHEComPro software is required for the calibration process. The “Service” role must be selected and service role password entered at software startup to allow write access to the calibration parameters.

Carry out the following steps:

1. Stop flow within the pipe and carry out the zeroing procedure. The meter should be full of process fluid.
2. Zero the totalizer on the electronics
3. Take a container large enough to hold a representative process sample and perform a tare on a weigh scale (for small meters this may be a small beaker or bucket, for large meters, this could be a truck). If an inline reference meter (for instance in a gas application) is to be used instead of weigh scales, prepare the reference meter by performing a zero and resetting the totalizer.
4. Start flow through the meter, collecting the delivered process fluid in the container. Where a reference meter is being used, the flow will also pass through the meter. Important - the mass flow rate must be within the normal measuring range of the RHMxx. Information on the normal flow range can be found on the sensor identification plate. The delivered volume/mass should be of a suitable size so as to provide a representative sample.
5. Stop the flow.
6. Weigh the delivered mass on the scale and note down the RHE totalizer value and the weigh scale value. Where a reference meter is used, note down the totalizer values from both meters.
7. Repeat the process twice more, noting the scale and totalizer values each time. Review the data collected for consistency and average the RHE totalizer values and the weigh scale or reference meter values.
8. Where the error between the instrument and scale readings are outside of the accuracy of the meter, the meter can be corrected by adjusting the internal K-Factor. To calculate the new K-Factor, use the following equation:

$$\text{“New K-Factor”} = \frac{\text{Reference}}{\text{RHE Total Mass}} * \text{“Old K-Factor”}$$

The new K-Factor derived from the above equation is entered into the setup parameter MassFlowKFactor (0x6922). Once the new K-Factor is entered, the calibration procedure should be run once again to validate that the meter is now reading correctly. If there is still a deviation between the reference measurement and the RHE total mass that is greater than the uncertainty of the meters, the complete calibration procedure should be repeated and another new K-Factor determined.

The RHEComPro software supports the calibration with the help of a dedicated dialog box, see section 1.8.3.

Note:



- The determination of a new K-Factor is best done at several different flow rates. Three different flow rates (at high, mid, low flow rate) is recommended. The resulting K-Factor for each flow rate can be compared and provided they are in close agreement, a mean K-Factor calculated for entry into the RHE transmitter.
 - These measurements are best made at the operating temperature of the process.
-

1.8.3 Calibration Support

When started in the maintenance mode the RHEComPro software program offers a “Calibration Support” submenu to assist in recalibrating the mass flow meter in the field/in a reference laboratory. Clicking on “Calibration Support” brings up the “Calibration Aid” dialog box. An example of the “Calibration Aid” dialog box is shown in Figure 2 below. For the calibration process only the part of the dialog box with the bluish background color is important.

The “Refresh from RHE” button updates the “Forward Totalizer”, the “K-Factor old”, the “Sensor Serial Number”, and the “Sensor Part Number” fields by values currently available at the RHE transmitter.

To perform a calibration using the Calibration Aid dialog box, follow the following procedure:

1. With the meter in a zero flow condition, click on the “Reset Totalizer” button to set the mass flow totalizer to zero.
2. Start flow through the meter and run to give a representative totalizer count for the meter size. Use an independent reference to determine the delivered mass. This reference may be a lab weight scale for small meters, a truck scale for large meters or an inline reference meter.
3. Stop flow and note the reference mass value. Click the “Refresh from RHE” button to read the current K factor from the RHE transmitter into the “K-Factor old” field. Enter the reference mass value into the “Measured Result” field and click the “Recalculate F-Factor”. A new, corrected updated K-Factor will be calculated based upon the RHE Totalized Mass, Reference mass and existing K-Factor. The new K-Factor will appear in the “K-Factor new” field for review.
4. Click on the “Set K-Factor only” button to install the new K-Factor into the RHE transmitter.
5. Repeat the calibration procedure to confirm that the new K-Factor calculates the correct mass flow value (within instrument uncertainty) when compared to the reference mass value.

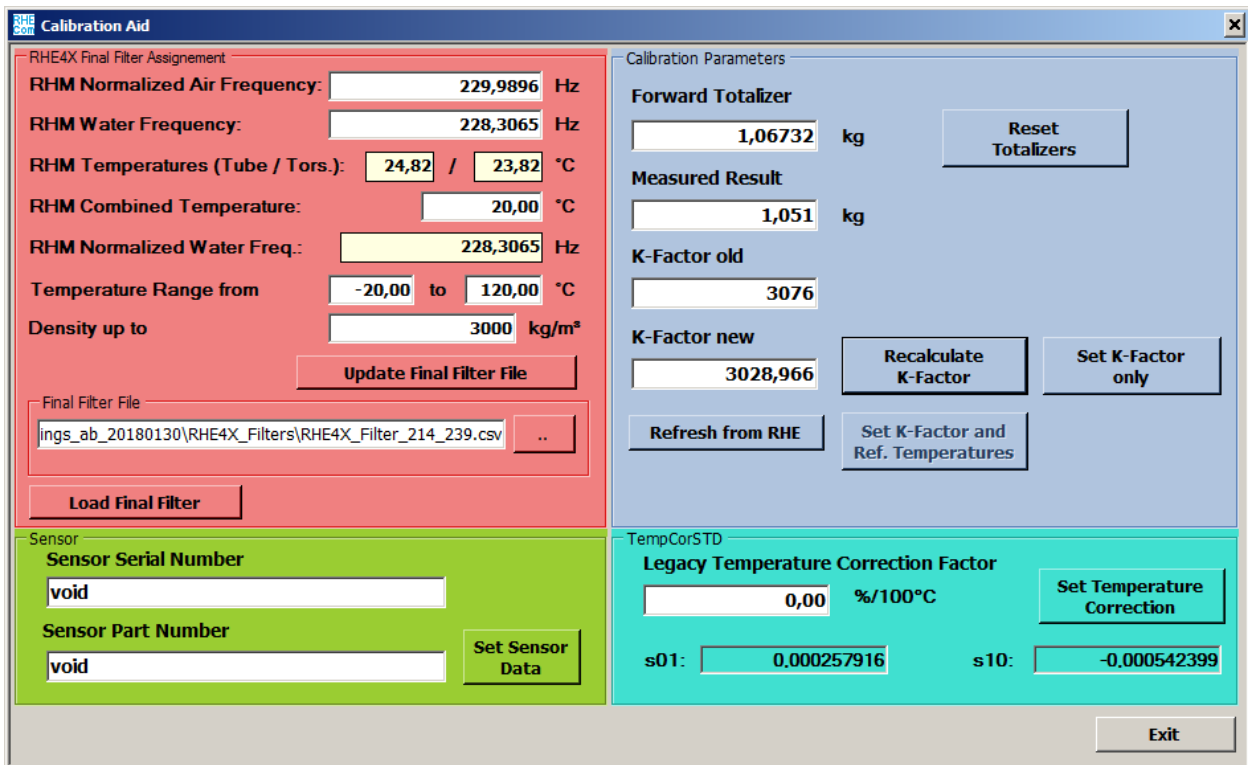

Figure 2: Calibration Aid Dialog Box

Note that all fields can also be entered manually providing the option to use a value totalized on an accumulator connected to the pulse output rather than the internal totalizer to calculate the new K-Factor.

The “Sensor Serial Number” and the “Sensor Part Number” fields in the part with the green background color are used when a sensor is bundled together with a RHE transmitter. The serial number of the sensor can be checked against physical numbers to ensure the correct sensor is being installed with the correct transmitter and therefore the factory installed calibration data is correct. Should the sensor be changed for any reason, the replacement sensor part number and serial number can be saved in the RHE transmitter for reference by entering the new data into the two fields and clicking “Set Sensor Data”. NOTE THIS DOES NOT ENTER CALIBRATION DATA RELATED TO THE SENSOR, JUST THE PART NUMBER AND SERIAL NUMBER.

2 RHEComPro Suite for Transmitter Configuration and Operation

The RHE transmitter is a fully featured device with many sophisticated functions. Careful configuration of the RHE transmitter is necessary if these functions are to perform as desired.

The simplest way to configure and setup RHE transmitter features and functions is through the RHEComPro software. This program has an intuitive user interface and allows the configuration of the RHE transmitter from a standard PC device via USB. Communication between the RHEComPro software and the RHE transmitter uses MODBUS protocol.

MODBUS protocol may also be used by other systems to configure the RHE transmitter and/or read measurement results through the RHE RS-485 port. Full details of the RHE MODBUS protocol implementation are documented in the section 2.2.

The configurable features and functions of the RHE transmitter are documented in section 4.

2.1 RHEComPro Suite Software Installation, License Handling, and First Steps

If you are not yet familiar with the RHEComPro Suite software it is recommended that you refer to the RHEComPro Suite User Manual, document number 8.2.1.29, for more information on the installation and license handling of this software as well as the first steps in order to get familiar with it. Since it contains many elements of its predecessor RHECom you should have no difficulties when updating to the RHEComPro suite.

The RHEComPro software and its documentation can be obtained from the Rheonik Service or via download from the Rheonik webpage www.rheonik.com. The basic version does not need a license and is free of charge. In order to test advanced features of the software suite, temporary evaluation licenses are available.

2.2 MODBUS Protocol Interface

The MODBUS protocol implemented in the RHE transmitter follows the standards defined by the documents “MODBUS over Serial Line Specification and Implementation Guide V1.02” and “MODBUS Application Protocol Specification V1.1b3” for OSI level 7. At OSI level 2 only RTU-type packets are allowed. MODBUS ASCII packets are not supported.

The following sections describe various aspects concerning MODBUS communication with the RHE transmitter and the access and modification of setup parameters.

2.2.1 Communications Interfaces

There are two communications interfaces built in to the RHE transmitter over which MODBUS communication takes place: a two-wire RS485 interface and an USB miniport.

The parameters of the RS485 interface are be configured via MODBUS holding registers. The following parameters may be defined:

Parameter (Address)	Default	Minimum	Maximum
Baud Rate (0x6010)	57600	9600	57600
Parity (0x6012)	Even	None	Odd
Stop Bits (0x6014)	1	1	2
Slave Address (0x6016)	1	1	247

When parity is set to none, the stop bits are automatically configured to 2 as required by the MODBUS OSI level 2 document.

The communication parameters of the USB interface are fixed and equal to the default setting of the RS485 interface: 57600 Baud, Even Parity, 1 Stop Bit, and MODBUS slave address 1. Because the communication parameters of the USB interface are fixed, any misconfiguration of the RS485 interface can always be corrected through this port.

According to the OSI level 2 MODBUS standard, RTU inter-frame delay ($t_{3.5}$) shall not be rated below 1.75ms even for high baud rates (see chapter 2.5.1.1 of the OSI level 2 document). This inter-frame time span must be adhered to by the MODBUS master.

When a USB adapter is used to communicate with a RHE transmitter, the adapter should be configured to suppress the echoing of characters send by the MODBUS master (sometimes called “RS485 Two-Wire Autogating”) for the best response time possible in order to meet the timing requirements of the MODBUS protocol.

2.2.2 MODBUS Commands Implemented in the RHE Transmitter

The RHE transmitter supports the following MODBUS commands:

Command	ID
Read Holding Registers	03
Read Input Register	04
Diagnostic	08 (with subcommands 0, 10-18, 20)
Write Multiple Registers	16
Read/Write Multiple Registers	23

For diagnostic and service purposes the “Read File record” and “Write File record” commands are also implemented. All other commands will cause an error return (exception code 1, ILLEGAL FUNCTION).

2.2.3 MODBUS Register Access

The RHE transmitter always combines two 16-bit MODBUS registers to 32 bit data units and four 16-bit Modbus registers to 64 bit data units. These registers always start at an even MODBUS address and any MODBUS transfer must specify the transfer of an even number of registers. Otherwise, an error is returned (exception code 2, ILLEGAL DATA ADDRESS). The same error is returned when a 64-bit data item is read and not enough space is allocated for it in the read command. 64-bit data items must be read and written as a contiguous unit in one MODBUS command. This is required to ascertain the consistency of the data item.

The interpretation of a 32-bit data item depends on its type:

Type	Description
UINT32	Unsigned 32-bit integer number in the range of 0 to 4294967295.
INT32	Signed 32-bit integer number in the range of -2147483647 to 2147483647.
FLOAT32	32 bit IEEE 754 floating point number in the range of about $-3.4 \cdot 10^{38}$ to $+3.4 \cdot 10^{38}$.
FLOAT64	64 bit IEEE 754 floating point number in the range of about $-1.7 \cdot 10^{308}$ to $+1.7 \cdot 10^{308}$.
STRING	ASCII-Encoded text string. Strings are always a multiple of 4 bytes in size as indicated by a number suffix, e.g. STRING4, STRING16, etc.

32-bit number items are transferred in the MODBUS packet as a big-endian data (most significant byte first). This means that all 32-bit numbers must be byte-swapped when transferred from or to a standard PC. This is not true for STRING data items which must not be byte-swapped.

The RHE transmitter uses an address range of 0x6000 to 0x6FFE for MODBUS holding registers and are mostly used for setup parameters. The MODBUS input registers are located in the address range of 0x4000 to 0x4FFE. Since these register ranges are unambiguous the MODBUS “Read Input Register” function may also be used to read holding registers.

Data sets designed for a fast access via multiple register reads are located in the address range of 0x5000 to 0x5FFE. The data in the registers in these sets are copies of registers defined in the other register ranges.

All MODBUS registers available in the RHE transmitter are listed in Appendix C.

2.2.4 Notes on the 32-bit Floating Point Precision

The use of 32-bit floating point numbers for the MODBUS interface has many advantages as they allow great flexibility in the units that can be specified for a measurement value without changing the underlying binary format of that value.

However, the precision of a 32-bit floating point number has a limit of about 6.5 decimal digits. Many numbers are displayed by the RHEComPro software program at maximum available precision and therefore minor imprecision e.g. caused by intrinsic rounding during a unit conversion calculation become visible to the user. Users should note that minor imprecision and/or inconsistency of displayed numbers can be ignored as their magnitude ranges far below any measurement uncertainty.

In some instances the RHE transmitter uses 64-bit floating point numbers internally in order to avoid the accumulation of error. Totalizers, for instance, use 64-bit floating point numbers. These values can be read out as 32-bit or 64-bit floating point numbers on the MODBUS interface level.

2.2.5 Access Level

In order to be able to modify a MODBUS holding register, a user must have been granted the access level of the respective register. In Appendix C the register descriptions are structured in accordance with the different access levels. The access level of any specific holding register can be deduced from the table header in which it appears in Appendix C.

In order to be granted a specific access level, the correct passcode must be written to the relevant holding register:

Level	Register Name	Register Address
NONE	-	-
USER	UserPassword	0x6004
SERVICE	ServicePassword	0x6000
FACTORY	FactoryPassword	0x6002

The default for the USER passcode is the string “1111”. This corresponds to the hexadecimal number 0x31313131. At the SERVICE or FACTORY access level a write to the UserPassword (0x6004) register will modify the passcode.

The service and factory passcodes are determined by an algorithm from the serial number of the device. The RHEComPro program will automatically login an operator to the “role” level he obtained successfully after having presented the correct password in the first dialog box of the program. Note that the password entered into the Role Login dialog box is not identical to the passcode written into one of the MODBUS holding registers.

For the readout of MODBUS holding or input registers no specific access level is necessary. Thus, a login does not need to be performed when registers are only to be read.

2.2.6 Modifying Setup Parameters

When the RHE transmitter setup is modified by writing new values to any of the MODBUS holding registers, these changes do not take effect immediately. All changes are kept in a shadow parameter set until the value 1 is written the register “Parameter Commit” (0x6006) upon which the shadow parameter set is written to non-volatile memory (EEPROM) in the RHE transmitter and will become effective after the next system reset or power cycle.

The writing of setup parameters to non-volatile memory takes less than one second. Thus, the MODBUS master has to configure a respective communication timeout to wait for the response when the “Parameter Commit” (0x6006) register is written.

A system reset is forced by writing the value 1 to the register “Reset Request” (0x6008). A complete system reset takes less than one second.

Note that writing to test parameter registers will always have an immediate effect. Test-related parameters are not stored in non-volatile memory and revert to their default values after a system reset or a power cycle.

The RHECom program automatically saves modified parameters to non-volatile memory and commands a system reset when a configuration is uploaded using the RHECom “Upload to RHE” button. RHECom will not trigger a system reset when only test parameters are modified.

The register address range of the setup parameters is subdivided into functional groups. The table below shows these functional groups together with the addresses of their first holding and input registers:

Group	Starting Addresses of Ranges
Mass Flow	0x6900 / 0x4900
Volumetric Flow	0x6A00 / 0x4A00
Density Calculation	0x6800 / 0x4800
Amplitude Diagnostic	0x6400 / 0x4400
Frequency Measurement	0x6200 / 0x4200
Phase Measurement	0x6300 / 0x4300
Temperature Measurement	0x6500 / 0x4500
Pressure Measurement	0x6600 / 0x4600
Generic	0x6000 / 0x4000
Totalizer	0x6B00 / 0x4B00
Zeroing	0x6700 / 0x4700
Unit Conversion	0x6100 / -
Current Output	0x6C00 / 0x4C00
Versatile Digital Output	0x6D00 / 0x4D00
HMI	0x6F00 / 0x4F00

Parameter groups are described in detail in section 4. Note that the role used to log in to RHECom determines which parameter groups are visible in the program.

2.2.7 Fast Access to Important Data

There are three fast access groups that combine the contents of several registers from different groups into one MODBUS address range to facilitate fast access via multiple register reads by a supervisory system in an industrial control environment.

Group	Starting Address
Combined Measurements	0x5000
Temperature Data	0x5100
Totalizer	0x5200

See section D.16 in the appendix for more details.

3 RHE20 Transmitter HMI Capabilities

The HMI of the RHE20 transmitter consists of a 128x64 pixel display, three input buttons, and three status LEDs located on the front face of the transmitter. The exact location and appearances of these elements are shown in the RHE type-specific installation manual.

With the help of these elements the status of the RHE transmitter may be checked and read out and all User or Service setup parameters may be changed. However, it is recommended to use the RHEComPro program for an extensive configuration change e.g. during the commissioning of an RHE transmitter.

The design of the HMI and the chosen fonts had the aim to maximize the readability and to safeguard the user from erroneous inputs. Fancy design elements which are contracting these aims were omitted.

In the next section the use of the RHE20 is explained on a stepwise basis. First the functionality of the input buttons is described followed by a guide through the different screens and menus. Thereafter, the inspection of measured data and status information is described, as well as the input of setup parameters.

3.1 Input Buttons

There are three buttons available for the RHE20 HMI: “ESC”, “NEXT”, and “ENTER”. Since this is a very small number of input alternatives for a complex task such as the input of floating point numbers these buttons have different functions in different screens and their functionality is situation-dependent.

The following table shows the buttons and their functionality in specific situations.

Button	Situation	Function
ESC	Menu Navigation	Selects the next upper menu level.
	Number Input	Leaves the input screen and returns into the associated menu level.
NEXT	Menu Navigation	Selects the next upper menu level.
	Mid- Input at a Digit	Increments the digit. A ‘9’ becomes a ‘0’ for decimal numbers, ‘F’ becomes a ‘0’ for the hexadecimal number input used for the service password.
	Number Input at a Sign	Changes ‘+’ to ‘-’ and vice-versa.
	Number Input at a Decimal Point	Shifts the decimal point and the input position to the right.
	Number Input at the End	When the entire input blinks the end of the input is reached. Pressing NEXT will return to the start of the input.
ENTER	Menu Navigation	Selects the next lower menu level or enters an input screen.
	Mid- Input at a Sign, Digit or a Decimal Point	Move the input position and the cursor to the right. Will cause an “End Input” condition when done at the rightmost input position and the number lies in an acceptable range. When a number is not acceptable it is displayed invers (white on black) and an ENTER at the rightmost position just wraps to the leftmost position.
	Number Input at the End	When the entire input blinks the end of the input is reached. Pressing ENTER accepts the modified number and returns to the associated menu level.
	Bit-Set Status Display	Increment the index of the chosen bit.

The user is encouraged to become familiar with the handling of the input buttons and to try some test inputs. Unless inputs are committed any parameter change will have no effect. It is recommended to reset the RHE transmitter either via the special HMI function or via a power-cycle to undo all non-committed changes after a test input, see also the end of section 3.5.

3.2 Presentation Screens

After a system reset the display shows the Start Screen as seen in Figure 3. This screen shows the type of the transmitter, its serial number, the software version, and the hexadecimal checksum of the firmware.

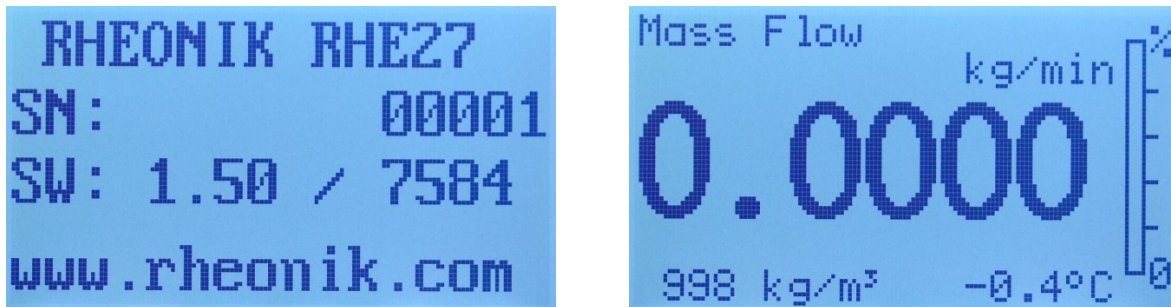

Figure 3: Start Screen and Default Presentation Screen

After a few seconds during system startup the Start Screen is replaced by presentation screen which is intended to display one of the important measurement values of the RHM/RHE system so that it can be read from a further distance. This measurement value also is represented as percent-scale to left based on user-specified warning levels or maximal ratings known to the system.

In addition to the main measurement value usually other measurement values such as the density (if available) and the tube temperature are displayed in a smaller fashion. For following measurement values presentation screens are available:

- Mass Flow
- Volumetric Flow
- Net Total Mass
- Net Total Volume
- Density (if available)
- Custody View

The NEXT button may be used to browse through the different presentation screen. When there is no button input for a certain time the HMI automatically returns to the default presentation screen. This timeout can be configured with the setup parameter ButtonInactiveTime (0x6F18) and the default screen can be set in DefaultScreen (0x6F1A).

The button activity timeout also is active when menus are navigated or data is inputted. When the timeout occurs also all login-information as User or Service at the HMI interface is revoked and must be repeated when necessary.

There is a separate button inactivity timeout which switches off the backlight LEDs of the display when it expires. This timeout is configured in DisplayLEDTimeout (0x6F16). A 0 in the parameter will force the backlight to on at all times.

When a presentation screen is displayed the top-level menu is reached with the help of the ENTER button.

The values on the presentation screen allow only 5 decimal digits for a positive number and 4 decimal digits for a negative number. Should a measurement value exceed the range in which a meaningful display is possible a “###.#” marker is displayed in order to indicate this. In this case a change of the underlying unit may return the value to the displayable range. However, this also

changes the unit for all other measurement values and setup parameter associated with it and thus should be considered carefully.

Should a measurement value be affected by an error condition the respective values are marked with a blinking “-.---” string. In this case the error condition should be analyzed and corrected.

The backlight of the display may emit different colors. In absence of error or warning conditions the backlight is either white or off. By default a severe error will switch the backlight to red and thus the blinking “-.---” string usually is accompanied by a red backlight. The backlight color depends on the setting of the setup parameter HMIBackgroundLEDs (0x6F1E). When the backlight has a different color than white it is never switched off. Thus, a missing lighting of the display has the same meaning as white and is an indication that not errors are present in the default configuration. In other configurations the red LED on the right side of the display should be observed to determine whether an error condition is present.

3.3 Menu Structure and Navigation

The top-level menu is selected when the ENTER button is pressed and a presentation screen is displayed. An item of the top-level menu can be seen in the left-hand image in Figure 4.

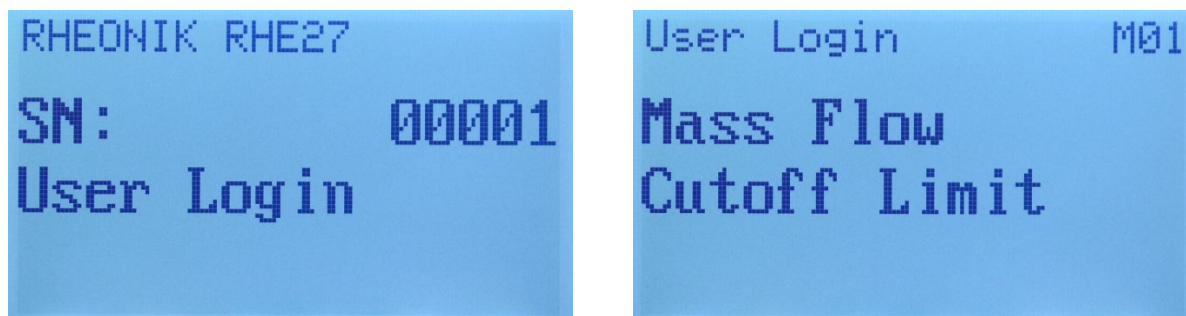

Figure 4: Top-Level Menu and Lower-Level Menu

In the first two lines of a top-level menu display the type of the transmitter and its serial number. In the third line the name of the next lower menu item is displayed. Menu items of the same level are browsed through with the help of the NEXT button. When the last item in a menu level is reached a press of the NEXT button will return to the first item of the same menu level.

Pressing ENTER chooses the currently active menu item and enters its lower menu level. For certain menu items a passcode has to be inputted, see section 3.6.1, before this happens. A typical lower menu screen is shown in the right-hand image in Figure 4. In this screen the line at the top shows the next upper menu level followed by the name of the currently active menu, here “Mass Flow”, and a selectable item, here “Cutoff Limit”.

As before the items in the active menu may be browsed by successive presses of the NEXT button. At the last item a press of the NEXT button will return to the first item in the menu. The number in the right upper corner of the screen shows the index of the current menu item. When this switches to “01” from a higher number the wrap to the first menu item happened. For menus which allow the modification of setup parameters a letter precedes this number which indicates the chosen menu. The “M” shown in the image represents the “Mass Flow” menu below the “User Login” top-level menu. Upper case letters are used for user setup parameters, the respective lower case letters are used for service setup parameter of the same type. Thus, an “m” indicates the “Mass Flow” menu under the “Service Login” menu.

When the ENTER button is pressed currently displayed menu item is selected. This either can be another lower menu level, a data display screen, or an input screen for a setup parameter. In the example above it will be the input screen of the “Cutoff Limit” setup parameter belonging to the mass-flow related parameter set.

When the ESC key is pressed in a lower-level menu the superior menu level indicated in the first line of the screen is selected and the first item of this menu is displayed. The navigation through the menu levels is strictly hierarchical. Lower levels can be activated with the help of the ENTER button, upper levels with the help of the ESC button.

The navigation through the menus with the help of the buttons is visualized in Figure 5. The top-level menu and a small portion of the menu structure is shown. The entire menu structure is found in Appendix C.

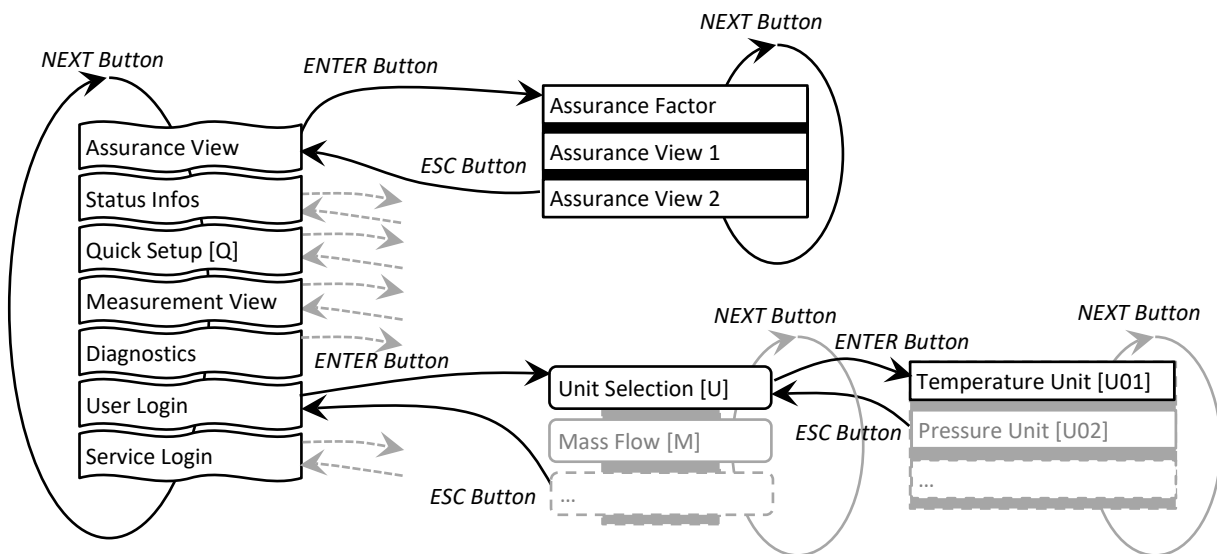

Figure 5: Navigation Through the Menu Levels

As it can be seen the top-level menu consists of

- Assurance View
- Status Infos
- Quick Setup
- Measurement View
- Diagnostics
- User Login
- Service Login

Below the “Assurance View” menu status information about the analog portion of the RHE transmitter is found. This mostly concerns the operation and stability of the RHM sensor. In the “Status Info” menu information about the RHE transmitter and its communication ports are found. The “Quick Setup” menu contains some basic mass-flow related setup parameters and the facilities to reset the totalizers or the RHE transmitter itself, see also section 3.5.3.

In “Diagnostics” the state of the different outputs and other service-relevant items can be queried. “User Login” contains the setup parameter which may be modified on the user level and “Service Login” contains the parameters to be modified by service personal.

Notes for Firmware Release 2.07: Starting with the Firmware Release 2.07 the HMI has been revised in accordance with customer feedbacks. Skipping parameters which are not used in a previously

selected configuration and skipping whole menus for unavailable interfaces or features was the first main improvement. So not all parameters or menus listed in the Appendix C are offered to be modified when RHEs or selected configurations do not need them. This shortens the list of all possible parameters considerably to a list of meaningful parameters. The identification displayed on the right upper side of the display is a recommended aid to navigate parameters in configuration menus.

The second improvement was done to the Quick Setup Menu. This menu has been extended to include the basic parameterization of the available I/O Interfaces. Furthermore, within the Quick Setup Menu the conclusion of an input of a parameter value automatically will start the input of the next meaningful parameter. This chain of parameter inputs may be suspended by pressing the ESC key when needed. Thereafter, the navigation inside menu proceeds as usual.

3.4 Data Display

The data display screens are used to display measurement values, setup parameters, or status information. The format of the displayed values can be integer, floating point, or bitset status information. Figure 6 shows the screens of a floating point number and a bitset status information. As it can be seen the name of the menu where the data item was selected in is displayed in the first line. In the next line the meaning of the value is shown.

3.4.1 Measurement Values

For floating point or integer values the value is displayed in a slightly larger font in the third line followed by a unit indicator in the last line.

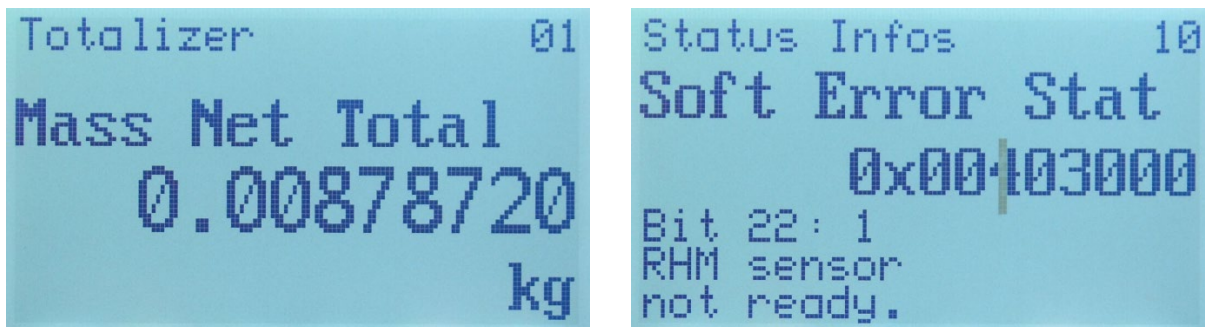

Figure 6: Measurement Value and Bitset Status

Whenever possible floating point numbers are displayed so that the number fits in nine decimal digits with one decimal point. Depending on the chosen unit a value may be too large to be displayed in this manner. In this case a scientific exponential notation is used in the form $5.6E12$ which means $5.6 \cdot 10^{12}$.

A blinking “-.-.-” string instead of the expected measurement value means that the measurement is affected by a severe error condition which must be analyzed and corrected.

3.4.2 Bitset Status Information

In the right-hand side of Figure 6 the screen for the display of bitset status information is shown. These are 32-bit values where every bit has a separate meaning. After the menu and the value identification this 32-bit value is displayed in a hexadecimal notation indicated by the “0x” prefix. This number is useful for the service but the meaning of each bit usually is not known by heart. Therefore, the currently selected bit, its value, and its meaning is displayed in the lower three lines of the display.

The bits are counted from 0 to 31. Initially, bit 0 and its meaning is displayed. The bit number can be incremented by pressing the ENTER key. Thereafter, the next bit and its meaning is shown. There is a tall cursor in the hexadecimal number which is shifted whenever the bit number is incremented. This cursor indicates the position of the selected bit in the 32-bit hexadecimal number. Each hexadecimal digit has four bit positions.

For the ErrorStatus (0x401A), SoftError (0x401C) and Warnings (0x401E) bitset status values usually only the bits with the value 1 are of interest because they indicate existing problems. Therefore, the user may skip over hexadecimal digits containing zeroes with four ENTER key inputs in order to advance to a position of a hexadecimal digit which is not zero.

3.5 Data Input

Data input screens are used to modify floating point or integer setup parameters. A typical data input screen is shown in Figure 7. As already explained for measurement values the first line contains the menu the parameter was selected from and the second line a small description of the parameter followed by the editable parameter value and a unit or a selection choice when applicable.

The letter and the number in the right of the first line are shown to ease the navigation through the menus and input screen and allow the reporting of input specific problems to service personnel. The letter depends on the upper menu level and the number is the index of the item in the menu. "M01" in Figure 7 means that the "Cutoff Limit" input screen is the first input screen in the "User Setup"/"Mass Flow" menu.

These letter/number combinations are also shown in the menu structure description, see Appendix C, and also can be used to look up the details of the HMI setup parameter in the Modbus register descriptions found in Appendix D where it is shown in brackets below the Modbus address of the respective register.

When a data input screen appears a blinking cursor is positioned at the leftmost digit. This digit may be incremented with the help of the NEXT button. An ENTER button press moves the cursor to the right. When the cursor is positioned on a decimal point a press on the NEXT button will shift the decimal point to the right to facilitate the input of a larger number. When the cursor is positioned on a sign the NEXT button can be used to toggle the sign from "-" to "+" and vice versa.

When the cursor is moved again from the rightmost digit the next press of ENTER button will accept the modified value and return to the previous menu. In order to signal this possibility the value does blink, see the right image in Figure 7. In this situation a press of the NEXT button will position the cursor at the first input position which may be a sign and the number is displayed normal again in order to signal the standard input state.

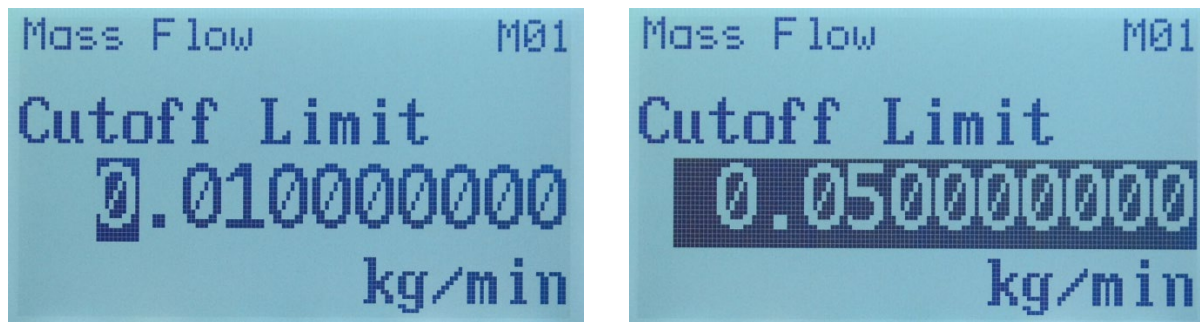

Figure 7: Start of Input and End of Input

The modified input values are permanently checked against an upper and lower bound. When a value exceeds the allowed range it is displayed inverted (white on black, non-blinking), see the left image in Figure 8. In this state a press of the ENTER key at the last position will wrap the cursor into the leftmost input position and the modified value cannot be accepted until it is corrected.

A press of the ESC key terminates the input immediately, ignores any changes, and returns to the previous menu. Thus, the ESC key also can be used to leave the input of a value outside the allowed range.

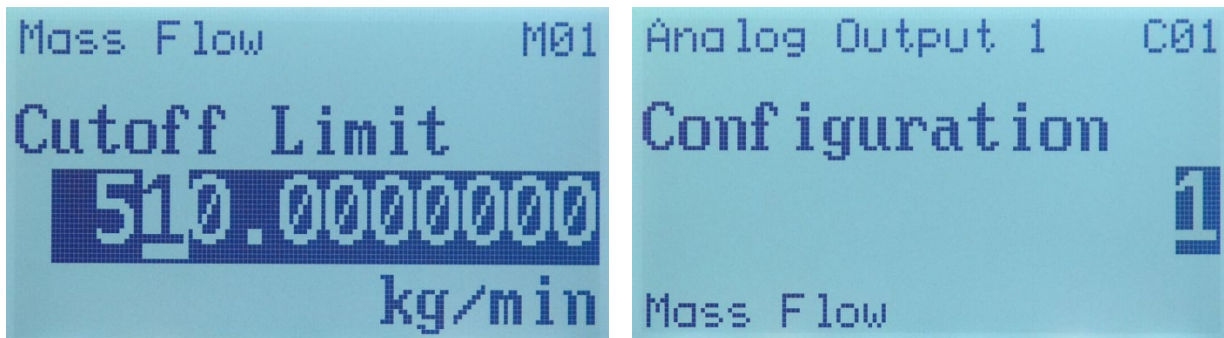

Figure 8: Input Range Exceedance and Choice Input Screen

3.5.1 Input of Floating Point Numbers

Most floating point numbers are stored as 32-bit units and have a precision of about 6 decimal digits. Since the input screen for floating point numbers allows the input of 9 decimal digits a rounding will occur after the 6th digits and the resulting number may not be the exact number that was inputted. This is normal and has to be expected, see also section 2.2.4 for further details.

Note that the numbers +99999999.9 and -99999999.9 have special meanings. They are converted to and from the maximum resp. the minimum 32-bit floating point numbers which really are values around $+7 \cdot 10^{38}$ resp. $-7 \cdot 10^{38}$. These values are used to effectively disable ranges used for system or user defined warnings.

Depending on the selection of a unit it is possible that a setup-parameter cannot be displayed in the 9-digit format of the floating point input screen. In this case the value is displayed as "#####" and no user input is allowed. The configuration still may be possible via the RHEComPro program which allows scientific exponential notations for very large numbers. Alternatively the unit associated with the value can be changed to allow a displayable representation of the value. This, however, changes the units of all values associated with it and should be done with care.

3.5.2 Input of Choices

The input of integers is done very similar to the input of floating point values. Sometimes different integer values of a setup parameter have different meanings in the sense of a choice, e.g. the values used for the configuration of an I/O interface. In this case the meaning of the current value is displayed in the last line of the display as shown in the right image of Figure 8.

These hint helps a user to perform complex configuration tasks without the need to consult the manual.

3.5.3 Save Setup or Discard Changes

As already described for the RHEComPro program modified test settings are effective immediately when they are accepted. However, modified setup values will be effective after the entire setup parameter set has been committed and the RHE transmitter is restarted. This allows a step-by-step configuration which may be inconsistent after the first step but will be consistent after a series of modifications are done.

After changes are done to parameters a return to the “User Login” or “Service Login” menu level via the ESC button from a lower menu level will trigger the option to commit and save the modified set and reset the RHE transmitter to activate the new settings. The respective screen is shown on the left side of Figure 9.

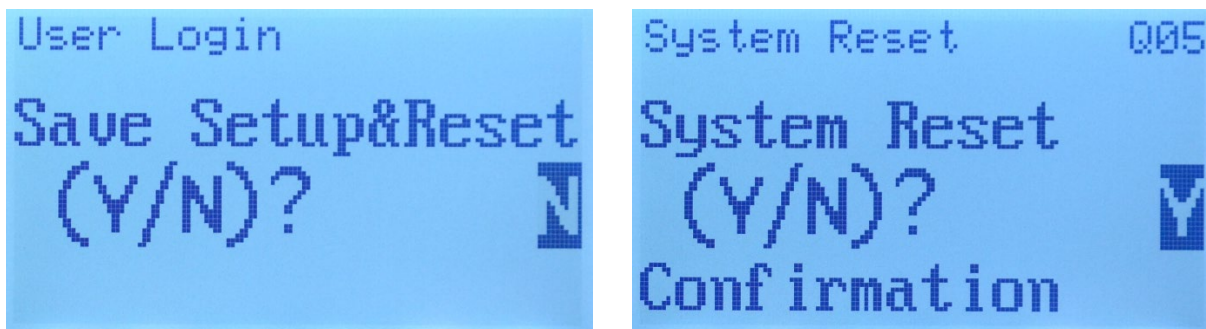

Figure 9: Parameter Commit Confirmation and Reset Confirmation Screens

The NEXT button can be used to toggle the choice between Yes and No, “N” resp. “Y”. When “Y” is chosen and the ENTER button is pressed the parameters are committed and the RHE transmitter is reset. When “N” is chosen followed by the ENTER button or the ESC key is pressed the setup is not yet saved and top menu level appears. The changes are not lost and still may be committed when the “User Login” or the “Service Login” menu is selected with the ENTER button and left again with the ESC key. As noted above, a password entry upon then entry into these menus is only required once in a session until either a system reset is performed or a button timeout forces the HMI to return to the presentation screen. Even after a button timeout any changed setup parameters are still present in the RHE transmitter.

In order to get rid of unwanted (and uncommitted) changes as well as possibly unwanted test settings an RHE transmitter reset without the save of the parameter set should be performed. A transmitter reset is found in the “Quick Setup” menu in the item “System Reset”. When this item is selected via a press of the ENTER key the screen shown in the right image of Figure 9 is displayed. As before, only the selection of “Y” via the NEXT button followed by an ENTER button press has an effect and resets the RHE transmitter.

After any modifications to setup parameters or the activation of I/O tests it is strongly recommended to either commit the changed parameter set or to reset the RHE transmitter without

saving any changes. This ascertains that no changed parameters linger in the system and may be used involuntarily by the next operator and also gets rid of any ongoing test modes.

A power cycle has the same effects for the RHE transmitter as the reset issued by the “System Reset” function.

3.6 Special Functions

There is a small number of special screens aside from the measurement value display and the modification of setup parameters:

- Password Login
- Zeroing Start
- Status View
- Assurance View

These screens are shown in Figure 10 below.

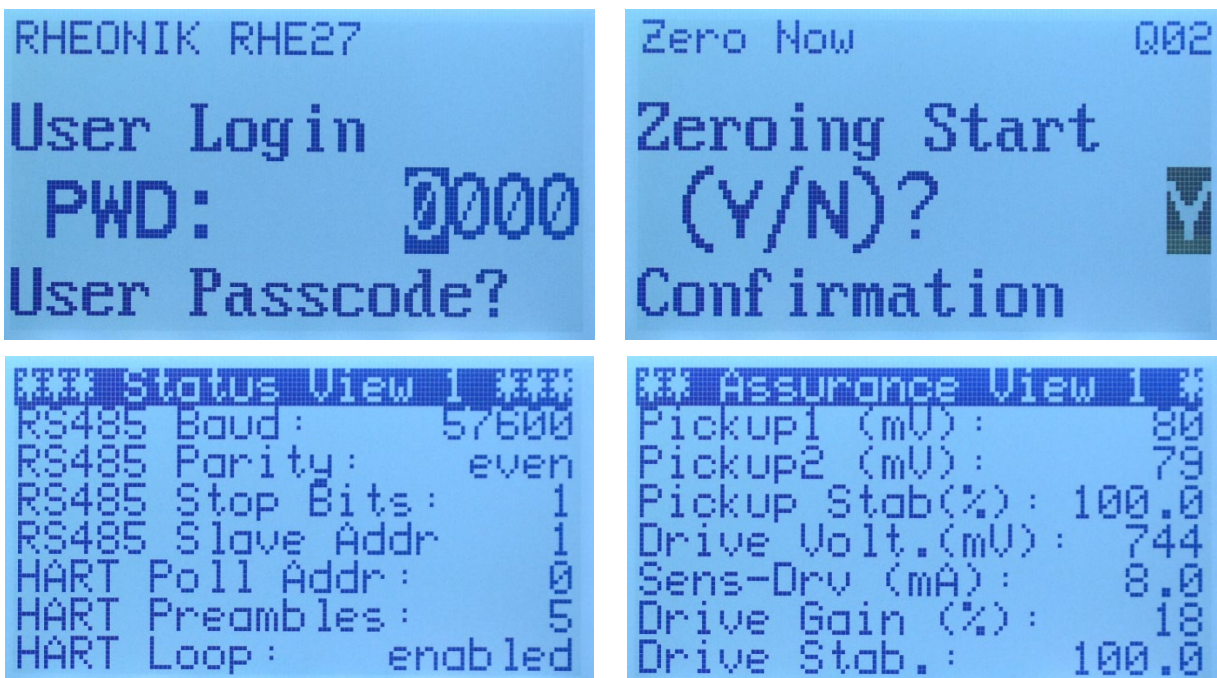

Figure 10: User Login, Zeroing Start, Status View and Assurance View Screens

3.6.1 Passcode Login

A passcode login screen is presented when a user enters the “User Login” or “Service Login” menu the first time. Unless the RHE transmitter is reset or a button timeout occurs the passcode entry screen is omitted when the same login menu is chosen again.

There are two usable passwords for the “User Login”. One password derives from the serial number and is always available. Another password can be selected and modified on the Service Level. However, the use of this password can be disabled by the setup parameter DisableDefaultPasswords (0x6F24).

Per default the modifiable password is set to “1111”. The passcode for the “Service Login” is a hexadecimal number which depends on the serial number. This number can be calculated with the

help of the “Passcode Calculator” dialog box available in the “Maintenance” / “Standard Maintenance Activities” submenu of the RHEComPro program when the Service Role is selected, see section B.1 in the appendix.

The passcode entry just works as the input of a normal integer number and must be accepted as described above. An ESC button press will abort the input and return to the top menu level.

When the Custody Lock switch is active an error message is displayed instead of the passcode login screen. No test settings or parameter changes are possible as long as the Custody Lock switch is active.

3.6.2 Zeroing Start

The zeroing procedure, see section 16, can be started with the help of the HMI from a special screen “Zero Now” available in the “Quick Setup” menu. This screen is shown in the right top image of Figure 10. When “Y” is selected and the ENTER button is pressed the zeroing procedure starts and a countdown is shown. When the countdown reaches 0 the zeroing procedure is concluded.

If the sensor is not ready an error message is displayed instead of the countdown.

3.6.3 Status and Assurance View Screens

In order to avoid the need to browse through a set of status information or measurement values data sets were created which present a number of related information to the user. These can be seen in the lower row of Figure 10.

The Status View screens are found in the “Status Information” menu where also other status information such as the error and warning registers (bitsets) are accessible. The Assurance View screens are found in the “Assurance View” menu where all kinds of diagnostic information is accessible which are related to the stability and performance of the RHM sensor and the RHE transmitter.

3.6.4 OIML / Custody Transfer Information

In order to support metrological supervision by a quality assurance or an official agency all important information regarding the RHE transmitter and its state is listed in a special “Custody Transfer” information display screen in the Status Info menu, see section C.2. Two screens are available and shown in Figure 11.

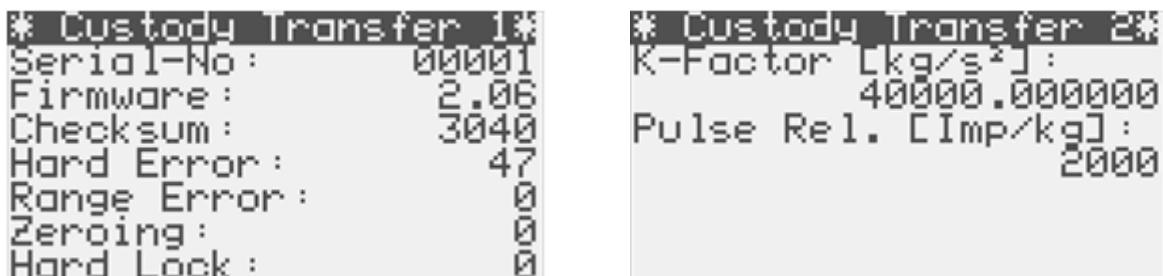

Figure 11: Custody Transfer Information Screens

The following items are displayed in the “Custody Transfer 1” screen:

Name	Contents / Meaning
Serial-No	Five digit serial number of the RHE transmitter. This number is defined by the factory and is unique.
Firmware	Version of the Firmware, e.g. "2.06".
Checksum	Four digit hexadecimal number representing the checksum of the firmware in the program flash memory. A firmware version of the same RHE transmitter type will have a specific checksum. If needed ask the Rheonik service for more information.
Hard Error	Number of hardware related failures such as temperature sensor or mass flow (RHM) sensor failures. In order to support the system startup hardware failures in the first 100 seconds after power-up are not counted. This number usually will be non-zero when a new transmitter is delivered because the production process will generate several such errors. The hard error counter will stop counting at 32767.
Range Error	Number of range errors where measurement results exceed the hardware ranges defined in the setup parameters. The range error counter will stop counting at 32767.
Zeroing	Number of zeroing procedures performed by the RHE transmitter. The zeroing counter will stop counting at 32767.
Hard Lock	Number of changes of the hard lock (custody transfer switch) when the transmitter is ordered with the hard lock option. This number will be even when the lock switch is open and odd when the switch is closed. The hard lock counter will stop counting at 32767.

"Custody Transfer 2" screen contains following items:

Name	Contents / Meaning
K-Factor	Calibration factor of the RHM sensor.
Pulse Rel.	Relation of one pulse to the mass or volume it represents depending on the configuration of the DO1 pulse output. The unit of the mass is fix [kg/lmp] and the unit of the volume is fix [m ³ /lmp]. When the DO1 pulse output is not configured to represent a mass or a volume the string "####" is displayed.
Powercycles	(Since Release 2.07) The number of power cycles detected by the RHE transmitter. This number does only count power cycles and ignores system resets, e.g. due to parameter changes. This value usually is not relevant for custody transfer purposes. See also Modbus register PowerCycleCount (0x404A).

It is expected that this information is recorded in a form during the commissioning of system by an official agency when needed. At this point the hard lock switch should be closed and the "# Hard Lock" counter should be odd. When the system is rechecked later, all information should be unchanged unless there is a plausible explanation for the deviation such as planned and allowed zero point determinations.

The four counters are only accessible via this menu in order to avoid any means to be manipulated. When the hard lock switch is open the counters can be reset by the "Reset Error Buffer" (0x600A) field if necessary, but since this also erases additional error information useful to the Rheonik Service this step should be avoided. It is expected that the counters last longer without being reset than the planned installation time span.

The current and the previous zero point values may be of interest, as well, and can be seen in the "Assurance View 2" display screen of the "Assurance View" menu, see section C.1. Since Firmware Release 2.03 the four counters also can be read out in the HMI-related Modbus input register range from 0x4F06 to 0x4F0C, see section D.15.2.1.

4 RHE Transmitter Configuration

The RHE transmitter is configured by writing setup values into specific MODBUS holding registers. This can be done via the HMI, but this may be tedious for a large scale configuration task e.g. during the commissioning of the RHE transmitter. Therefore, it is recommended to use the RHEComPro program to perform extensive configuration changes.

The Modbus holding registers are listed and defined in Appendix C. MODBUS protocol is used to communicate with the RHE transmitter through either the mini-USB socket on the front face of the RHE transmitter or the two-wire RS485 serial interface.

The RHEComPro software package (see section 2) is available to ease configuration tasks, but because communications strictly adhere to MODBUS rules, other proprietary MODBUS capable software programs/packages may also be used to modify setup parameters.

The following subchapters describe the configuration of the main features of the RHE transmitter. Throughout these subchapters, it is assumed that the relevant RHE transmitter registers have already been properly configured for the attached RHM flow sensor type and that a calibration has been performed at the factory. From this base condition, the end user need only modify User or Service level parameters to integrate the unit into their overall control/measurement scheme. The following subchapters are arranged in the recommended sequence of parameter changes.

4.1 Unit Handling

By default the RHE transmitter uses following engineering units internally for all measurement calculations:

Unit	Measurement
°C	Temperature
hPa	Pressure
kg	Mass
kg/min	Mass flow
m ³	Volume
m ³ /min	Volumetric flow
kg/m ³	Density

For user convenience, RHE transmitter register values can be configured for different engineering units by the end user. The RHE transmitter automatically converts values between user defined units and the internally used engineering units as needed when MODBUS register reads/writes are performed.

The simplest way to set up the RHE transmitter to operate with user required engineering units is via the “Configuration” / “Unit Selection” submenu of the RHEComPro software as described in the RHEComPro Suite User Manual.

Engineering units can also be set through the “Unit Conversion” tab in the Device Configuration window of the RHEComPro program. Figure 12 below shows the “Unit Conversion” tab.

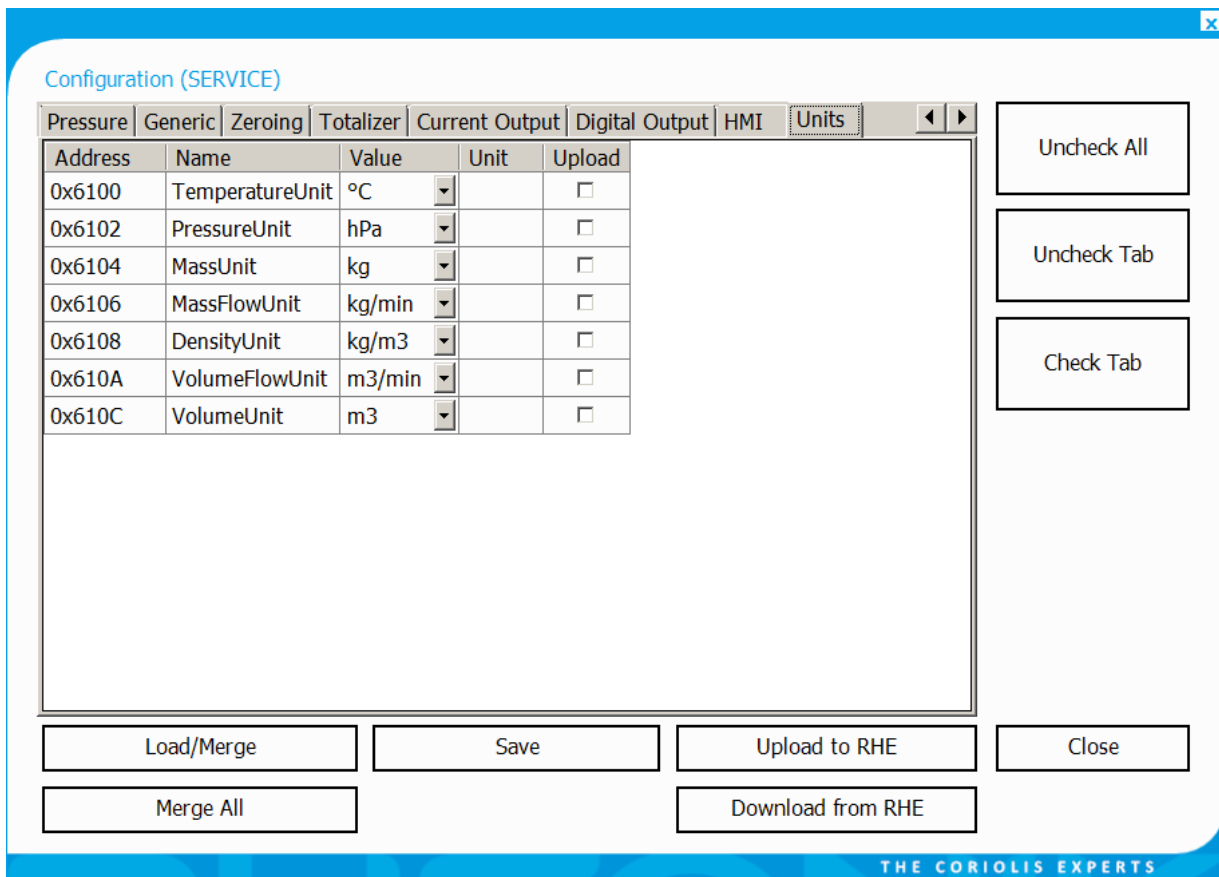

Figure 12: RHEComPro Unit Conversion Tab of the Configuration dialog box.

When setup parameters are displayed in tabular form in the RHEComPro software, the unit of any MODBUS register where a unit conversion is possible is displayed with a blue background. For all parameters with fixed units, the unit is displayed with a white background.

The specification for the unit conversion MODBUS registers can be found in Appendix D.12. Almost any meaningful metric or imperial unit can be selected.

It is **strongly recommended** that engineering units are set before any other RHE transmitter parameters are modified. After unit selection has been changed, the units **must be committed** and **must be activated by a system reset**. This is automatic when the parameter “Upload to RHE” function button is clicked in the RHEComPro software and the upload is confirmed.

The committing and the activation of the modified setup parameter set is necessary to convert existing values to the equivalent value in the new unit (i.e. 100°C will be converted to 212°F when temperature units are changed from C to F). Failure to commit and activate will result in values which are not correct for the newly selected units because the RHE transmitter still will use the old conversion settings in order to convert modified parameters.

The RHE20 transmitter series features a small set of “norm” and “standard” units, such as Norm Cubic Meters (Nm³) or Standard Cubic Feet (SCF) together with some related volumetric flow and density units. These units must be used in sets, e.g. “Nm³” for volume, “Nm³/min” for volumetric flow, and “kg/Nm³” for density, in order to obtain a consistent relation of the respective measurement values.

Some units feature a limited range in which the respective conversions are valid. For example the unit conversion for the Brix density unit is limited to the range from 0 to 40°Bx.

4.2 Mass Flow Rate Parameter Setup

Mass Flow Rate is the primary measurement of an RHM/RHE system. All of the Mass Flow Rate setup parameters and their MODBUS holding registers are detailed in Appendix D.1. Most of these parameters are set when the RHE transmitter is configured and calibrated at the factory. The values set at the factory include K-Factor (sensitivity to the mass flow), temperature correction parameters, and error limits. Figure 13 below shows the Mass Flow tab in the Configuration window of the RHEComPro program.

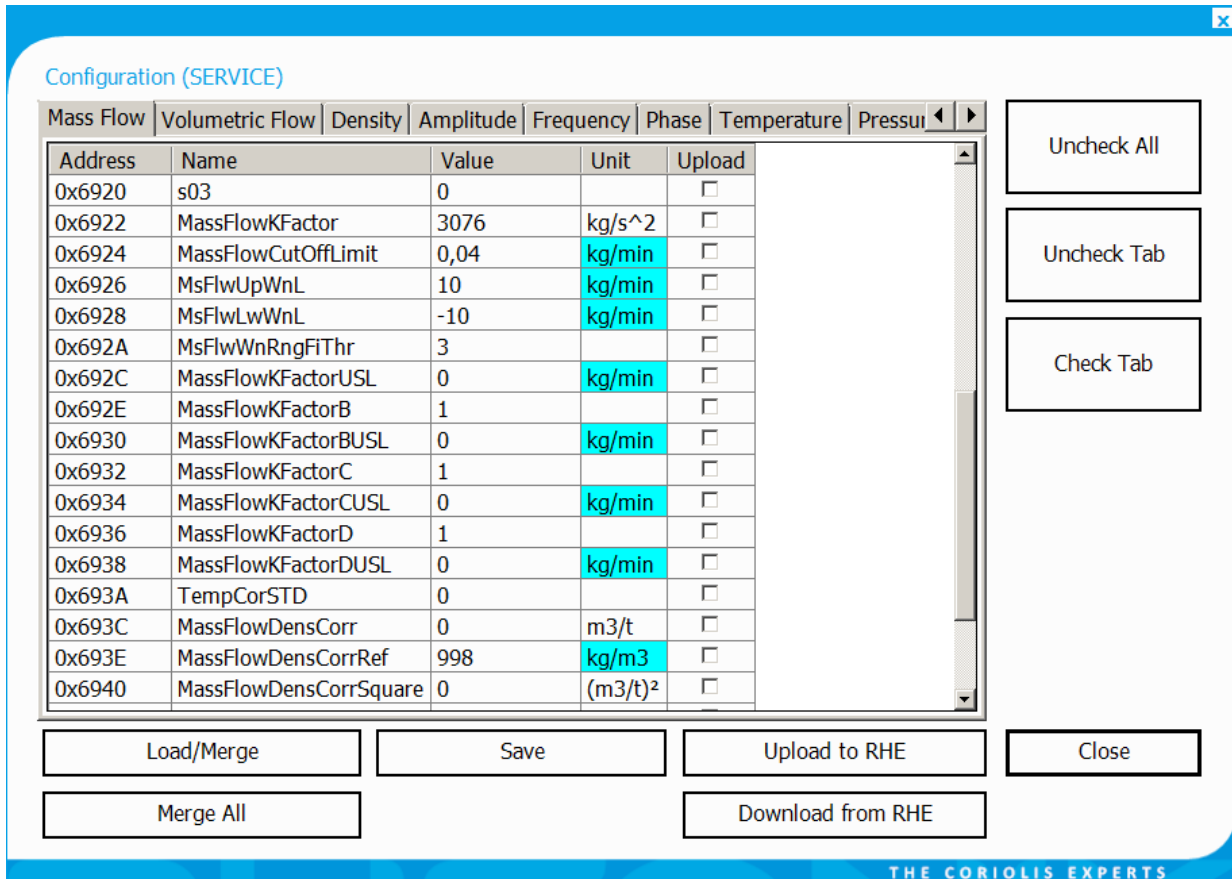

Figure 13: Mass Flow Tab of the Configuration dialog box.

4.2.1 Flow Direction

Positive mass flow direction can be set by the user. The flow direction parameter, PhsFlwDirConfig (0x6306) is found in the Phase Measurement parameter set (see Appendix D.6 for more information). The RHM Coriolis sensor is bidirectional and can be installed inline with either process connection upstream. This flexibility allows for installation where there are mechanical, access or other limitations. Depending upon which way the meter is installed, it may be necessary to change the flow direction parameter to ensure that a positive mass flow value is calculated/totalized for the preferred flow direction and that a negative mass flow rate value is calculated/totalized for a reverse flow. The PhsFlwDirConfig parameter must be changed (from 1 to 0) to change the direction of flow in the transmitter.

4.2.2 Cut Off Limit

The Cut Off Limit (also known as zero cut off limit), MassFlowCutOffLimit (0x6924) is used to specify a minimum mass flow rate under which the mass flow rate is assumed to be zero. This function

filters out any measurement noise which would result in small positive or negative flows being indicated when the flow rate is actually zero. Any actual mass flow rate below the cutoff limit will be reported as zero mass flow and not tallied in the totalizers, or the pulse and current outputs if present. The cut off limit works symmetrically around zero; the set limit has the same effect when flow is in the positive direction as it does when flow is in the negative direction. Figure 14 shows the effect of the cutoff limit depending on the mass flow.

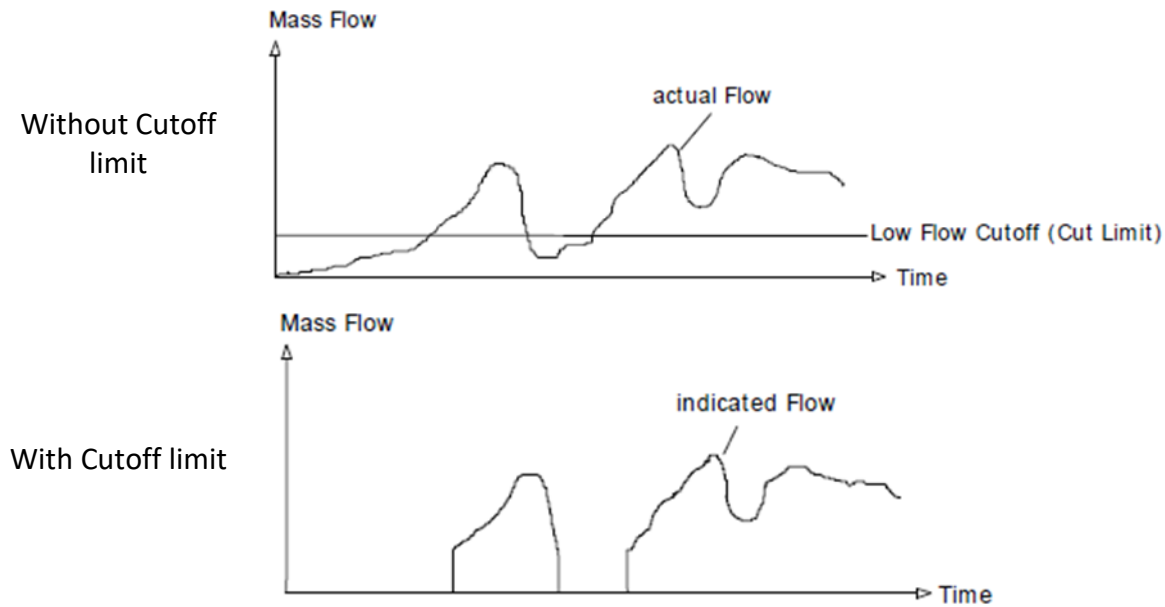

Figure 14: The effect of the cutoff limit.

By default, the Cut Off Limit parameter is set to about 20% of the minimum measurement range of the RHM flow sensor, see Equation 1. This value is preset at the factory when an RHE transmitter is delivered together with an RHM flow sensor. The minimum measurement range is usually stated as being 2% of the maximum measurement range. The default Cut Off Limit is therefore 0.4% of the maximum measurement range of the RHM flow sensor.

$$\text{Cutoff limit} = \text{Minimal Flow rate} * 20\%$$

Equation 1

The Cut Off Limit value can be reduced to accommodate smaller mass flows if required, but at low mass flow levels noise may increase. The value of the phase filter (see Appendix D.6 for more details) can be increased to help limit measurement noise. This filter can be adjusted using the “Mass Flow Damping” slider in the Filter Dashboard window. After moving the slider to adjust the filter value, click on the “Set Modified Filter Parameters” button to transfer the new setting into the RHE transmitter setup parameter set.

4.2.3 Max/Min Mass Flow Warning Limits

Warning limits may be set to warn when mass flow is outside of predefined levels. A lower (MsFlwLwWnL) and an upper mass flow limit (MsFlwUpWnL) are available and can be set at User Level log in. When mass flow is outside these limits, a warning is signaled by setting bit 1 (upper bound) or bit 17 (lower bound) in the Warnings (0x401E) register. By default, mass flow warning limits are disabled by setting these fields to the maximum and minimum possible values. Note that the maximum and minimum mass flow warning limits may be set both positive, both negative or positive and negative depending upon the flow regime.

4.2.4 Mass Flow Filter Setting, Damping

The mass flow measurement in the RHE is based on the phase measurement. Therefore, all major filter parameters concerning the flow measurements are found in the “Phase Measurement” configuration tab of the “Device Configuration” dialog box. Following parameters are available:

Address	Name	Description
0x630A	PhsFilNoSamples	Phase Filter Number of Samples: Number of samples for the phase filter which determines PhaseFilteredInterim (0x4306) out of PhaseRawZero (0x4302). The filter is based on a sensor frequency/4 sampling rate. Reducing this value will shorten the integration time. The range is from 1 to 200 (100 until Firmware V1.2.4) and the default value is 5.
0x6366	FlowFilterDisplayTau	(Since 1.76) Filter Time Constant for Displayed Flows: Filter Time Constant for the optional additional flow filter used for displayed flows. This filter affects both the displayed mass and the displayed volume flow. The unit of this value is seconds. The range is from 0.0 to 60 seconds. The value 0.0 switches off this additional filter. This also is the default value. The filtered flows can be monitored in MassFlowRateDisplay (0x4906) and VolFlowRateDisplay (0x4A04).
0x6368	FlowFilterFreqTau	(Since 1.76) Filter Time Constant for Flows of Frequency Outputs: Filter Time Constant for the optional additional flow filter used for flows converted to frequency outputs. This filter affects both the mass and the volume flows used as inputs to the frequency outputs. The unit of this value is seconds. The range is from 0.0 to 60 seconds. The value 0.0 switches off this additional filter. This also is the default value. The filtered flows can be monitored in MassFlowRateFreq (0x4906) and VolFlowRateFreq (0x4A04).
0x636A	FlowFilterModbusTau	(Since 1.76) Filter Time Constant for Filtered Modbus Flows: Filter Time Constant for the optional additional flow filter used for Modbus related control loops. This filter affects both the mass and the volume flows. The unit of this value is seconds. The range is from 0.0 to 60 seconds. The value 0.0 switches off this additional filter. This also is the default value. The filtered flows can be read from MassFlowRateModbus (0x4908) and VolFlowRateModbus (0x4A06) to be used in dedicated control loops for which the input has to be additionally filtered.

The most important filter parameter is PhsFilNoSamples (0x630A) as it determines the characteristics of the primary filter. This primary filter influences the entire data processing regarding the mass and volume flow and the response time of the totalizers. Unless important reasons prohibit a filter with a fast response time this should be set to value which results in a filter time of about 50ms. Since the parameter depends on the sensor frequency/4 it should be set to about 4 or 5 for 220 Hz RHM sensors.

When the “Precision Mode” is selected the filter time should not be chosen to be less than 50ms.

The RHE transmitter supports individual secondary filtering of the flows in different data processing paths resulting in different data sources some of which may be the basis of a flow-based control loop. This could be the Modbus input registers, the frequency output or the display. By default all secondary filters are disabled and their time constant Tau is set to 0.

The figure below gives an overview over the available filters and their associated data flows.

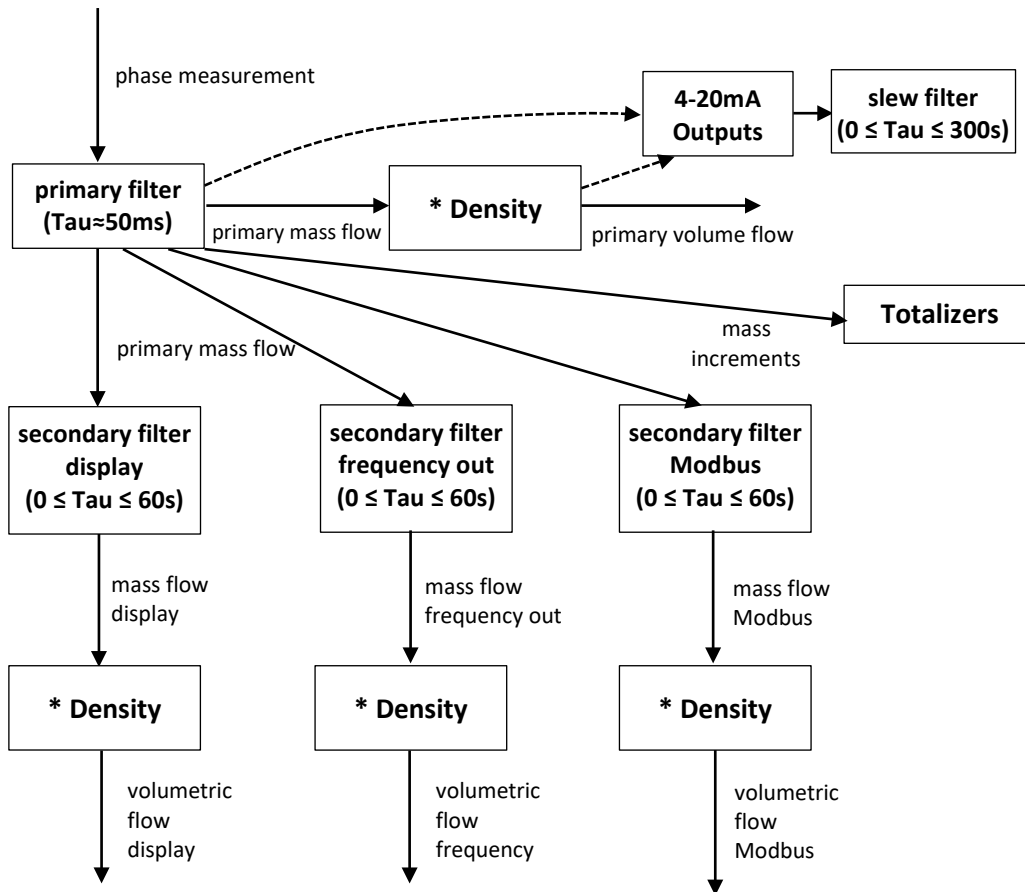

The setup parameter FlowFilterFreqTau (0x636A) controls the secondary filter which determines the response of the frequency output to flow changes. The Modbus input register MassFlowRateFreq (0x4906) reflects the filtered input of the frequency generator.

Similarly the setup parameter FlowFilterModbusTau (0x636A) controls the secondary filter which determines the response of the Modbus registers MassFlowRateModbus (0x4908) and VolFlowRateModbus (0x4A06) to flow changes.

The changes of the flows perceivable at the HMI display can be dampened with the help of the FlowFilterDisplayTau (0x6366) filter parameter. This is helpful when a mean value of an unsteady flow shall be visualized. This parameter also is present in the fast access record as described in D.16.1 and allows a display of the mass flow with similar values as seen on the HMI of the transmitter.

The current outputs feature their own filter parameters, CurOutDampingTau, CurOut2DampingTau, CurOutDampingBand, and CurOut2DampingBand which are effective on all measurements selected as inputs and are not restricted to the flow measurements.

4.3 Density Parameter Setup and Calculation

Volumetric flow is calculated by the RHE transmitter from the mass flow rate and the density of the material in the flowing line. The DnsConfig (0x6800) register is used to identify the way the density value is determined in the RHE transmitter:

Value	Method
0	Off. No density value available. Volumetric flow remains 0 and is shown as “-.—” in the presentation screens of the display as is the density.
1	Density is determined from the frequency of the RHM flow sensor using density calibration factors. The RHE transmitter must be ordered with the density calibration option, otherwise this setting is ignored.
2	Density is set to the value found in the updateable VolFlwNorDensCurr (0x6838) register which in turn is initialized from the VolFlwNorDens (0x6832) setup register. Any write to the VolFlwNorDensCurr (0x6838) has an immediate effect. Thus, the density used by the RHE transmitter may be periodically updated via Modbus writes to this register.
3	Temperature corrected density calculated from a base density value in VolFlwNorDens (0x6832) at a reference temperature dnsRefTmpNorDns (0x6834), an expansion factor dnsTmpCoeff (0x6836) and the actual RHM Tube Temperature (AdcTubeMeanTemp) with the following formula: $DenComp = \frac{VolFlwNorDens}{1.0 + dnsTmpCoeff * (AdcTubeMeanTemp - dnsRefTmpNorDns)}$ (internal °C representation of the temperatures is used).
4	A density sensor is attached to the 4-20mA Input. In this case the registers AdcRawMin (0x6600), AdcRawMax (0x6602), AdcFilNoSamples (0x6608), AdcCalOffset (0x6618), AdcCalGain (0x6620), DnsValMin (0x6622), and DnsValMax (0x6624) in the “Pressure” register group are used for the density measurement and must be set accordingly. A DnsConfig (0x6800) value of 4 takes precedence over a PressureCalcConfig (0x6610) value of 2 to 4 or 6 to 7.

Values 2 and 3 are recommended for gases or where the density is known to be within well-defined limits. When internal density calculation is selected by using value 1, care should be taken that the RHM flow sensor is not subject to external vibrations.

Value 4 is used when an external density sensor is attached to the Analog Input. See section 4.10.3 for further information.

When the DnsConfig configuration 2 is selected the user has the ability to dynamically update the density value via Modbus writes to register VolFlwNorDensCurr (0x6838). The performance of some RHM sensors may be improved by enabling the density correction for the mass flow calculation, see also registers MassFlowDensCorr (0x693C) and MassFlowDensCorrRef (0x692E), and performing a periodic update of the density of the substance in the tube of the RHM sensor.

The density value is found in the DenComp (0x4806) register. Full details of the registers related to density calculation are found in Appendix D.3. Most of these registers are used for the internal density calculation, namely to describe the properties of the RHM flow sensor and the density calibration information. Figure 15 below shows the density configuration tab in the Configuration window of the RHEComPro software:

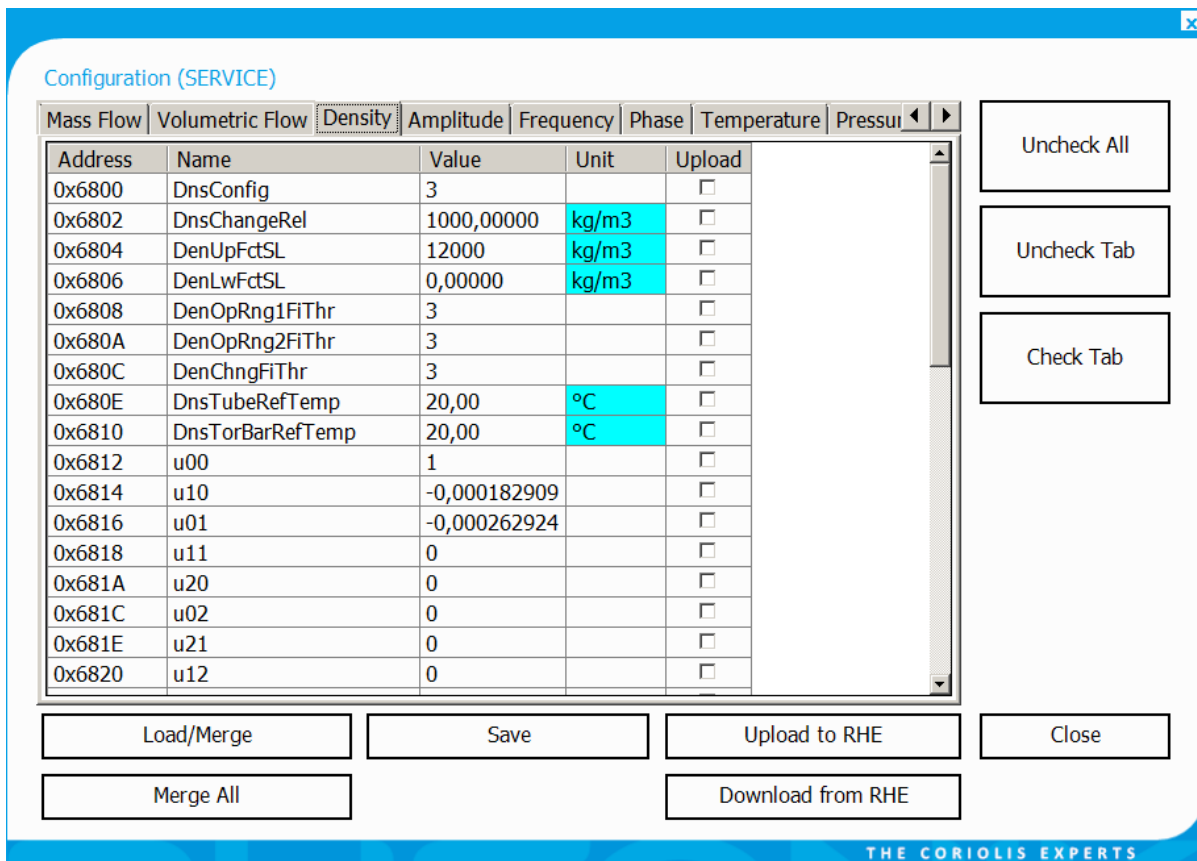

Figure 15: Density Tab of the Configuration dialog box.

When density measurement is based on the frequency of the RHM sensor the parameters related to frequency (see Appendix D.5 for details) can be used as diagnostic indicators when problems arise. The size of the frequency measurement filter, FreqFilNoSamples (0x6208), can be increased should density measurement fluctuate.

Furthermore, an additional filter is available in DenTau (0x6848, since release 1.76) to smoothen the density value when it is calculated by the transmitter itself. The filtered density value will be used for the volume calculations.

4.3.1 Max/Min Density Warning Limits

Warning limits may be set to warn when density is outside of predefined levels. A lower (DenLwWnL) and an upper density limit (DenUpWnL) are available and can be set at User Level log in. When density is outside these limits, a warning is signaled by setting bit 0 (upper bound) or bit 16 (lower bound) in the Warnings (0x401E) register. By default, density warning limits are disabled by setting these fields to the maximum and minimum possible values.

4.3.2 API Standard Density

When the API Standard Density calculation feature is present in the firmware as indicated by a non-zero value in the Generic parameter APIDnsPresent (0x6092) and the density is calculated from the sensor (1 in DnsConfig [0x6800]) it is possible to switch the density handling inside the RHE transmitter to the API Standard Density calculated out of the measure density. The calculation is done on the basis of the “Manual of Petroleum Measurement Standards Chapter 11—Physical Properties Data” document.

For this purpose, the parameter APISubstanceType must be configured with the type of the hydrocarbon substance present in the RHM sensor.

Value	Type	Remark
0	None	API Density calculation is disabled
1	Crude Oil	Crude Oil in the density range of 610.6 to 1163.5 kg/m ³ .
2	Refined Product	Gasoline, Diesel, Heat Oil, Jet Fuel, etc.
3	Lubricant	All kinds of lubricants in the density range of 800.9 to 1163.5 kg/m ³ .

When a value in the range of 1 to 3 is selected and the conditions mentioned above are fulfilled the API density is calculated out of the measure density, the measured tube temperature, and the available pressure data and stored in the input register StdDensity (0x480A). The measured density still is available in the DenComp (0x4806) input register.

Furthermore, when the API density calculation is active the following features of the RHE transmitter will then be based on the API Standard Density:

- Volume Flow and Volume Total,
- HMI Density Presentation Screen,
- Density visible on the main dashboard of the RHEComPro program,
- 4-20mA Current Outputs when “Density” is selected as data source,
- Frequency Outputs when “Density” is selected as data source.

When the API density calculation detects a problem such as an overflow one of the density, temperature, or pressure ranges defined by the API Standard bit 27 of the Warnings (0x401E) register indicates an invalid API density calculation. In this case, the density and consequently the volume data is probably incorrect.

Note that the register StdDensity (0x480A) contains the same value as DenComp (0x4806) when the API density calculation is not enabled or available.

4.4 Volumetric Flow Rate Parameter Setup

When a density value is available in the RHE transmitter, it uses this value to calculate a volumetric flow rate in conjunction with the current mass flow rate. The registers related to volumetric flow rate are detailed in Appendix D.2. Figure 16 below shows the “Volumetric Flow” setup tab in the Configuration window of the RHEComPro software:

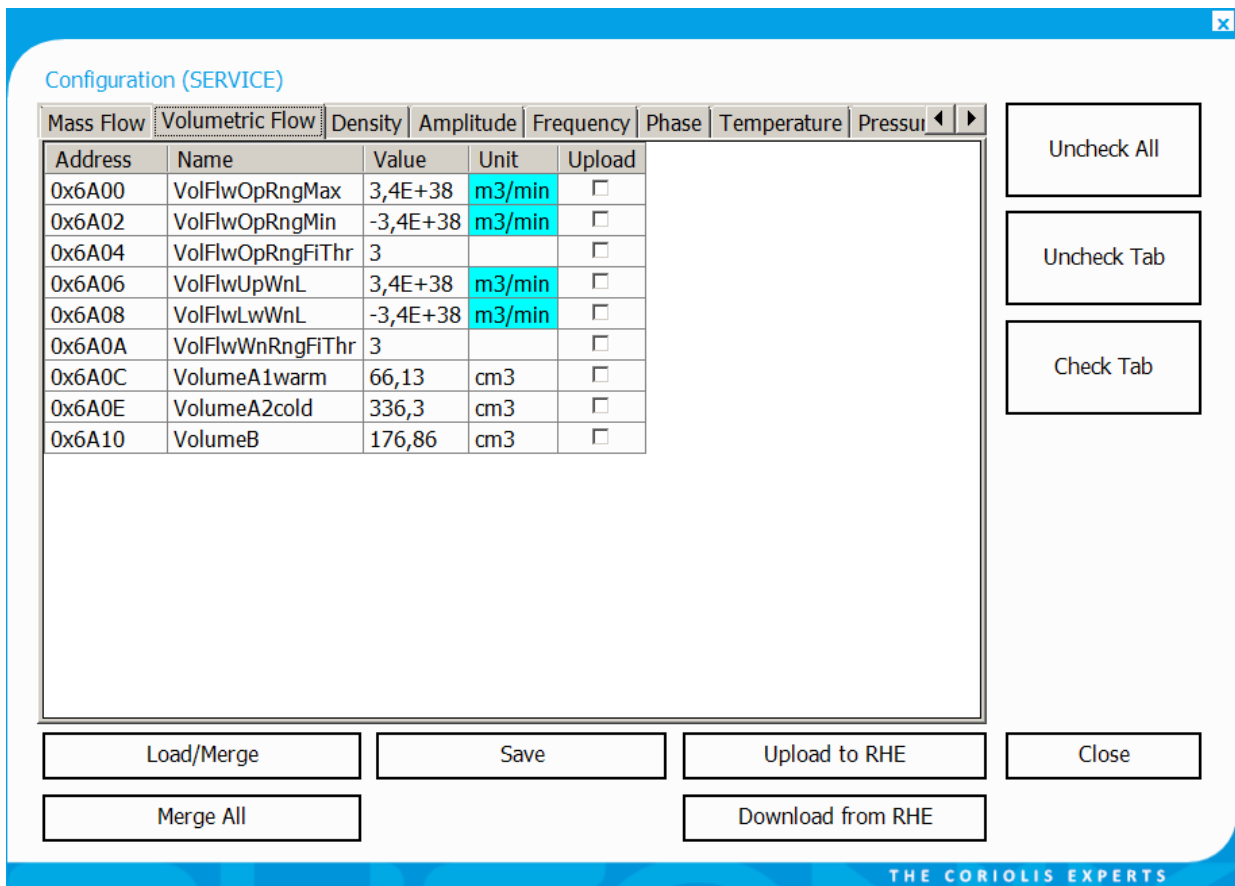

Figure 16: Volumetric Flow Tab of the Configuration dialog box.

4.4.1 Max/Min Volumetric Flow Warning Limits

Warning limits may be set to warn when volumetric flow is outside of predefined levels. A lower (VolFlwLwWnL) and an upper volumetric flow limit (VolFlwUpWnL) are available and can be set at User Level log in. When volumetric flow is outside these limits, a warning is signaled by setting bit 2 (upper bound) or bit 18 (lower bound) in the Warnings (0x401E) register. By default, volumetric flow warning limits are disabled by setting these fields to the maximum and minimum possible values. Note that the maximum and minimum mass flow warning limits may be set both positive, both negative or positive and negative depending upon the flow regime.

4.5 Totalizer Handling

The MODBUS registers related to the various totalizers are detailed in Appendix D.10. The net totalizers integrate the mass and volume flow rates to a total mass or volume. In the net totalizers, positive flows are added to the totalizer value and negative flows are subtracted from the totalizer value. The forward totalizers TotalMassFwd (0x4B00), TotalVolFwd (0x4B02) add up only forward flow, the reverse totalizers TotalMassRev (0x4B08) and TotalVolRev (0x4B0A) add up only reverse flow.

The net totalizer registers, TotInvenMassNet (0x4B04), TotInvenVolNet (0x4B06), are controlled by changing the value of the TotInvenReq (0x6B00) register. Depending upon the value of the TotInvenReq (0x6B00) register, the net totalizers can be reset, stopped and started. Note that writing a new value to this register has an immediate effect and that value will persist after a system reset or a power cycle. When the totalizers are stopped and firmware version 2.10 or higher is

installed, the pulse outputs in mode 1 to 6 and 15 to 18 are stopped, as well. Thus, the pulse output exactly follows the totalizers.

In addition to this standard totalizers there are two overall totalizers TotNetSumMass (0x4B14) and TotNetSumVolume (0x4B16) which are permanently running. These overall totalizers can be reset when bit 8 is set when writing the TotInvenReq (0x6B00) register. This corresponds to adding 256 to the intended command value – most likely a reset (2) which would result in a command value of 258. Further bits may be set in order to ascertain that the totalizer is reset when there is not current mass flow or the forward mass total is in TotalMassFwd (0x4B00) not 0 before the command is executed properly. When the corresponding condition is not fulfilled a Modbus error code 4 (failure) is returned.

The contents of the totalizer registers are saved to non-volatile memory, from which they are restored after a system reset ensuring contents are not lost due to system reset or power cycle.

Internally the totals all are implemented as double precision floating point numbers. A problem would arise with this precision when the addition of a small mass to a huge total would result in the loss of precision. The problem theoretically would become critical when a total contains about 10^6 times the mass as the RHM sensor is able to measure in a minute (nominal maximum flow). This would require a continuous operation of about one year at maximum flow rate.

Since the double precision totals are read out as single precision values the problem may be perceivable much earlier as a change in the totals may not be seen as expected due to rounding issues during the read-out of the data. Therefore, it is recommended that the totals are reset periodically, e.g. daily, when they are intended to be used with a fine resolution.

4.5.1 Max Totalized Flow Warning Limits

Warning limits may be set to warn when the net flow totalizers exceed predefined levels. An upper limit for the net total mass (TotInvenMassOvflw) and an upper limit for the net total volume (TotInvenVolOvflw) are available and can be set at User Level log in. When total mass exceeds the limit, a warning is signaled by setting bit 8 in the Warnings (0x401E) register. When total volume exceeds the limit, a warning is signaled by setting bit 9 in the Warnings (0x401E) register. By default, these limits are disabled by setting these fields to the maximum possible values.

4.6 Temperature Measurement Parameters

The temperature of the flow tube and torsion bar in RHM flow sensors are primarily measured and used for temperature correction of mass flow rate and density values. The temperature sensor is in intimate contact with the meter tube and therefore gives a good approximation of process temperature. Tube temperature can be used as an additional process measurement point in an automated environment. Torsion bar temperature and the internal temperature of the RHE transmitter electronics can be monitored as diagnostic values to provide indication of stable operating conditions and confidence in the measurement.

The registers related to the temperature measurement are detailed in Appendix D.7. The settings of temperature-related parameters necessary for operation with RHM flow sensors featuring one or two temperature sensors is described in the type-specific installation manual.

4.6.1 Max/Min Temperature Warning Limits

Warning limits may be set to warn when tube and torsion bar temperature is outside of predefined levels. Lower (AdcTubeDegCelMin (0x650A), AdcTorBarDegCelMin (0x650E)) and upper

(AdcTubeDegCelMax (0x650C), AdcTorBarDegCelMax (0x6510)) temperature limits are available. When temperature is outside of any of these limits, a warning is signaled by setting bit 3 in the Warnings (0x401E) register. By default, temperature warning limits are disabled by setting these fields to the maximum and minimum possible values. Note that the maximum and minimum temperature warning limits may be set both positive, both negative or positive and negative depending upon the flow regime.

4.7 Pressure Management

The performance of some RHM sensors may be improved by activating a pressure correction for the mass flow calculation. The respective registers and a function overview is given in section D.8. A live measurement with the help of a pressure sensor attached to the Analog Input is described in section 4.10.

The initial system pressure must be set for the Modbus holding register PrsExternalInitial (0x6612). This value is copied to the register PrsExternalCurrent (0x6620) during the startup of the RHE transmitter Register PrsExternalCurrent (0x6620) is the basis of the pressure correction and any writes to it have immediate effects. Thus, a varying system pressure may be transmitted to the RHE transmitter by periodically updating the PrsExternalCurrent register.

Rheonik provides a pressure correction factor found in MassFlowPressCorr (0x661E) and a reference pressure stored in PrsCorrRef (0x661C) in order to activate the pressure correction of the mass flow calculation.

4.8 Digital Output Setup

The RHE transmitter can be ordered with a digital output option. Depending on the model this option adds up to four digital outputs to the I/O capability of the RHE transmitter. Outputs 1 and 2 are versatile outputs and can be configured as either pulse outputs, indicating unit mass or volume throughput or frequency outputs that increase or decrease proportionally to transmit flow rate and/or density or may be configured as status outputs like outputs 3 and 4. Outputs 3 and 4 can be configured to indicate transmitter and alarm status. The submenu activated by “Configuration” / “Digital Output Configuration” in the RHEComPro software package provides access to convenience dialog boxes which offer an easy means to configure the versatile pulse/frequency and the status outputs.

The MODBUS registers related to the digital outputs are detailed in Appendix D.14. Figure 17 below shows the “Digital Output” setup configuration tab in the Configuration window of the RHEComPro Software with some of the available parameters.

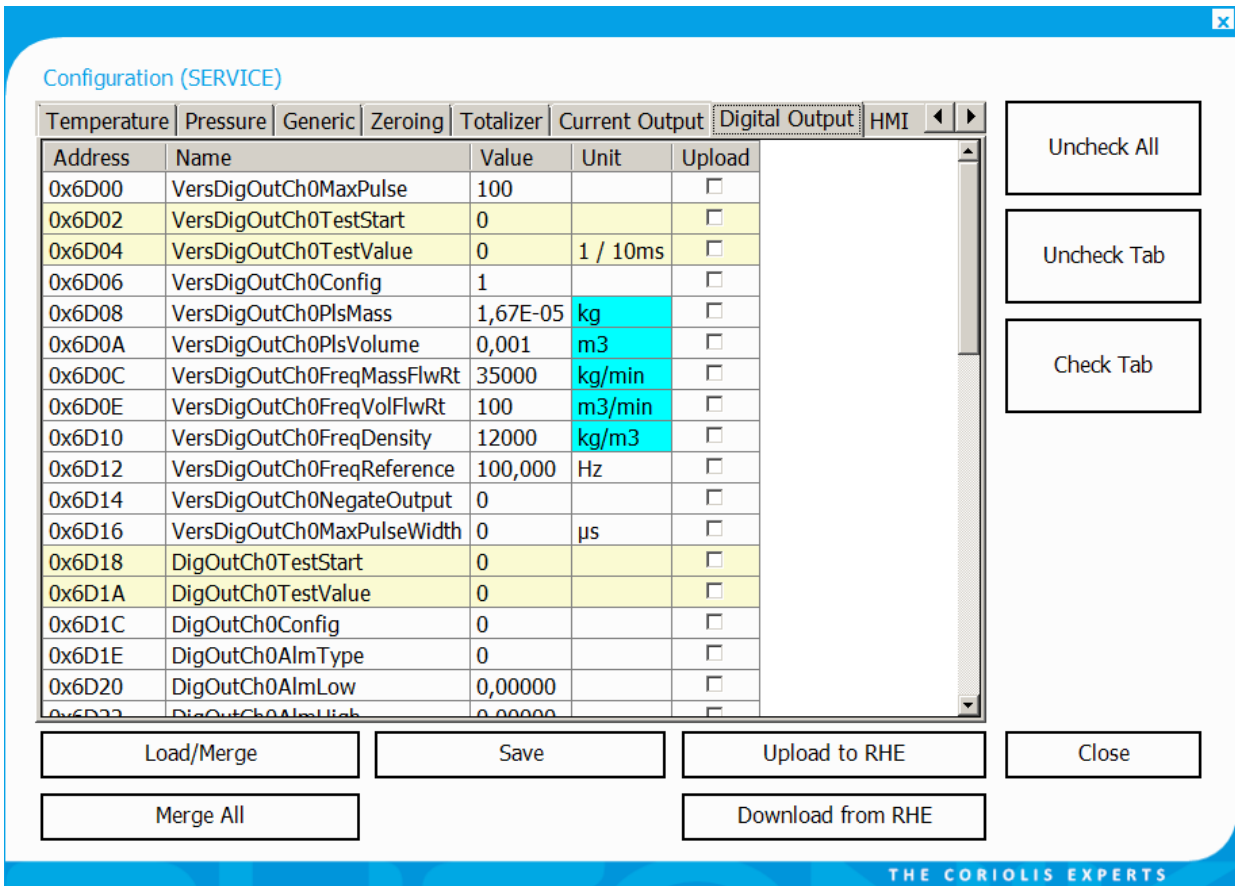

Figure 17: Digital Output Tab of the Device Configuration dialog box.

Due to a longer history of Modbus parameter set the indices and the naming of parameter sets for the digital outputs of RHE transmitter is not straight-forward. The table below shows the interrelation between the number at the terminals, the functionality, and the name and addresses of the respective parameter set.

When the Pulse/Frequency Output 1 is configured “Off” it functions as Digital Output controlled by the parameter set of which the names start with “DigOutChA”. Similarly, a disabled Pulse/Frequency Output 2 becomes a Digital Output controlled by the parameter set of which the names start with “DigOutChB”.

Name at Terminal	Function	Setup Parameter Naming	Address Range
PO1	Pulse/Frequency Output 1	VersiDigOutCh0	0x6D00 – 0x6D16
	Digital Output A (1)	DigOutChA	0x6D30 – 0x6D3A
PO2	Pulse/Frequency Output 2	VersiDigOutCh1	0x6E00 – 0x6E16
	Digital Output B (2)	DigOutChB	0x6E30 – 0x6E3A
DO1	Digital Output 3	DigOutCh1	0x6E18 – 0x6E22
DO2	Digital Output 4	DigOutCh0	0x6D18 – 0x6D22

As it can be seen the Digital Output 3 is controlled by a parameter set which a higher channel indication as Digital Output 4. This based on historical configurations when output 4 was assigned to the “Error” signal and output 3 to the “Direction” signal.

4.8.1 Alarm Outputs 3 and 4, A and B

When the transmitter model supports the respective digital outputs alarm outputs 3 (digital output channel 1) and 4 (digital output channel 0) are present on terminal 3 and 4 respectively. When the frequency outputs are configured “Off” further alarm outputs A or B on the terminals of DO1 and DO2 will be available.

All alarm outputs can be setup to operate in 3 different modes:

- Setpoint – the output will activate/close when the setpoint is exceeded
- Inbound – the output will be closed when the measured value is between the set limits
- Outbound – the output will be closed when the measured value is outside of the set limits

Operation type is set in the DigOutCh0AlmType / DigOutCh1AlmType / DigOutChAAImType / DigOutChBAImType registers.

The measurement source for either output can be selected as mass flow rate, volumetric flow rate, density, tube temperature or torsion bar temperature, forward mass totalizer, forward volume totalizer. The last two data sources are useful for a batch filling mode, see section 4.12.

Additionally, output 4 or output A at terminals 4 resp. 1 can be configured to indicate when the transmitter has an error condition and output 3 or output B at terminals 3 resp. 2 can be configured to signal flow direction. The measurement source type is configured in the DigOutCh0Config / DigOutCh1Config / DigOutChAConfig / DigOutChBConfig registers.

By default, output 4 or output A indicates error condition. In default configuration, output 4 or output A is low when one of the bits in the ErrorStatus (0x401A) or SoftError (0x401C) registers are set and the outputs are high when no error conditions exist.

By default, output 3 or Output B signals the flow direction. A low state indicates positive flow.

Each alarm has an upper and lower limit or bound associated with it. These limits/bounds are set in the register pairs DigOutCh0AlmLow / DigOutCh0AlmHigh, DigOutCh1AlmLow / DigOutCh1AlmHigh, DigOutChAAImLow / DigOutChAAImHigh, resp. DigOutChBAImLow / DigOutChBAImHigh. When output type is selected as a setpoint, the lower limit is used as a hysteresis value that resets the alarm after violation when the measurement value underpasses it.

Since firmware release 2.17 the limit registers for a digital output X (X=0, 1, A, or B), DigOutChXAlmHigh and DigOutChXAlmLow, are used to set the initial values for the registers DigOutChXAlmHighCurr and DigOutChXAlmLowCurr which are found in the Modbus address range immediately below the respective DigOutChXAlmHigh register. A write to these new DigOutChXAlmHighCurr and DigOutChXAlmLowCurr will have an immediate effect on the internal evaluation of the state for the respective digital output. Thus, e.g. the target mass of a batch filling application may be updated before the filling is started and no commit and reset operation is required.

Full details can be found in Appendix D.14

Alarm limits can be configured and set using the “Configuration” / “Digital Output Configuration” submenu, or in the “Digital Output” setup configuration tab in the Configuration window, of the RHEComPro software. When configuring using the “Configuration” / “Digital Output Configuration” submenu and the “Digital Output Status” submenus a dialog box like the one shown in Figure 18 below will appear:

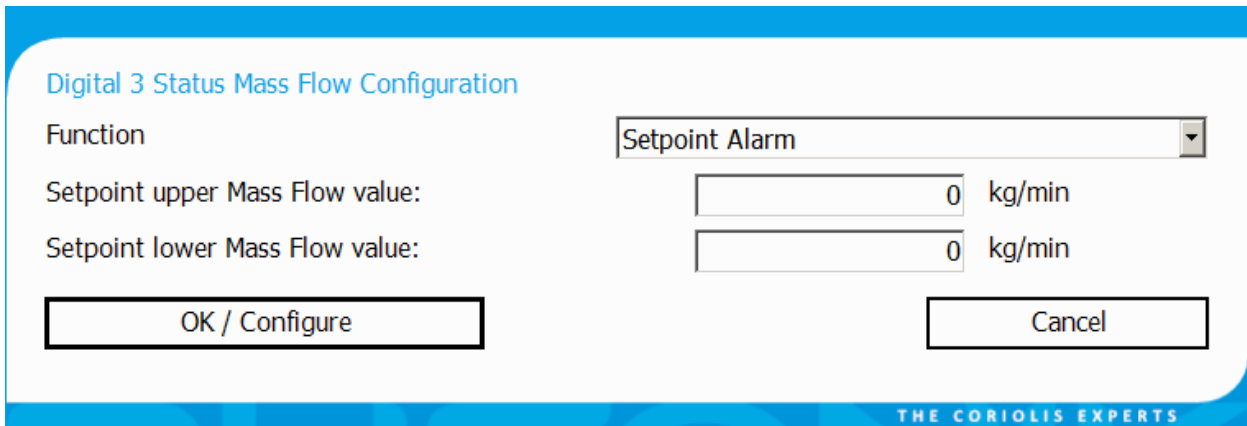

Figure 18: Digital Status/Alarm Configuration Dialog Box.

This dialog box provides the “Function” drop down box to select the alarm type and two boxes to enter upper and lower limit values. The configuration is transferred to the RHE setup parameter set when the “OK/Configure” button is pressed.

4.8.2 Versatile Pulse/Frequency Outputs 1 and 2

Versatile outputs 1 (versatile digital output channel 0) and 2 (versatile digital output channel 1) can be independently configured to operate in either pulse mode or frequency mode. In pulse mode, the output is configured to pulse each time a predetermined mass or volume is registered by the flow meter during flowing conditions. In frequency mode, the output is used to proportionately indicate either mass or volumetric flow rate or measured density across as a varying frequency signal. The versatile outputs can be set to operate in several different ways:

- Mass Flow – Simple Pulse, Forward Flow
- Volume Flow – Simple Pulse, Forward Flow
- Mass Flow – Pulse1 & Pulse2 90 Degrees phase shift
- Volume Flow – Pulse1 & Pulse2 90 Degrees phase shift
- Mass Flow – Simple Pulse, Reverse Flow
- Volume Flow – Simple Pulse, Reverse Flow
- Mass Flow Rate Fast Frequency Output
- Volumetric Flow Rate Fast Frequency Output
- Density Fast Frequency Output
- Mass Flow Rate Slow Frequency Output
- Volumetric Flow Rate Slow Frequency Output
- Density Slow Frequency Output
- Mass Flow Rate RHE Compatibility Mode Frequency Output
- Volumetric Flow Rate RHE Compatibility Mode Frequency Output

Operation type is set in the VersDigOutCh0Config / VersDigOutCh1Config registers for versatile outputs 1 and 2 respectively. The Slow and Fast Frequency modes are not recommended any more as this would require a special processing setup which rarely is available in an installation. Please try to use the Compatibility Mode Frequency Output instead. The output of mode represents the current flow as well as reasonably well the transferred mass or volume. For the exact representation of the transferred mass of volume a respective pulse mode is needed, which however does not represent the current flow well.

When the totalizers are stopped and firmware version 2.10 or higher is installed, the pulse outputs in mode 1 to 6 and 15 to 18 are stopped, as well. Thus, the pulse output exactly follows the totalizers. The frequency output is not affected by the totalizer control settings.

4.8.2.1 Pulse Width and Pulse Frequency Limit

The maximum pulse frequency in all modes can be limited with the help of the parameter VersDigOutCh0MaxPulse (0x6D00) for output 1 respectively VersDigOutCh1MaxPulse (0x6E00) for output 2. The value in these fields specifies the maximum number of pulses the RHE transmitter will output in a 10ms time interval. Thus, the default number of 100 specifies a maximum 10000 Pulses per second or a 10 kHz frequency. The value 10 would specify the maximum of 1000 pulses per seconds which sometimes is needed to be compatible to older mechanical flow meters. When this register is set to 0 in connection with the pulse modes 1, 2, 5, 6, or 15 to 18 a special Slow Pulse Mode with a maximum pulse rate of 50 Hz is configured which is described in section 4.8.2.3.

When the number of calculated pulses in one of the flow modes surpasses the configured pulse frequency limit the maximum number of allowed pulses are generated in the following 10 ms interval and the raining pulses are accumulated in a backlog accumulator to be outputted at a later time when the calculated pulse rate falls below the pulse rate limit.

Thus, in the totalizer based flow-oriented pulse mode the total outputted pulses always will correspond to the totalizer in accordance with the configured conversion factor and pulses may be generated based on the contents of the backlog accumulator even after the physical mass flow has ceased. This can be avoided by a proper configuration of the pulse output where the maximum expected flow is converted to a pulse rate lower than the maximum allowed pulse rate.

By default the generated pulses have 50% duty cycle in all modes. The pulse width is controlled by the parameter VersDigOutCh0MaxPulseWidth (0x6D16) for output 1 resp. VersDigOutCh1MaxPulseWidth (0x6D1E) for output 2. This parameter specifies the maximum pulse width in μs units in the range of 50 to 4000 μs . A specification of 50 μs corresponds to a 50% duty cycle at the maximum output frequency of 10 kHz. When the value in this register is set to a number below 50, e.g. to the default value 0, a 50% duty cycle is used.

When the maximum pulse width would result in pulses with a duty cycle of more than 50% the actual pulse width is reduced to generate pulses with 50% duty cycles. Thus, the specified maximum pulse width is not guaranteed to also specify a minimum pulse width unless the maximum pulse frequency in VersDigOutChXMaxPulse (0x6D00 or 0x6E00) is limited to a pulse frequency whose period time is at least twice the maximum pulse width. For example, a maximum pulse width of 500 μs together with a maximum pulse frequency of 1000 Hz (10 in VersDigOutChXMaxPulse) is guaranteed to generate pulses with a 500 μs duration because 1000 Hz correspond to a period of 1000 μs or 1 ms.

The following parameter set is recommended for gas filling station control systems which also accommodate mechanical types of flow meters with non-overlapping 90° duplicate pulses and a minimum pulse width of 400 μs . Any reverse flows are ignored.

Setup Parameter	Modbus Address	Value
VersDigOutCh0MaxPulse	0x6D00	7
VersDigOutCh0Config	0x6D06	3
VersDigOutCh0NegateOutput	0x6D14	3
VersDigOutCh0MaxPulseWidth	0x6D16	400

Note, that a pulse width limitation normally should not be applied when the 90° pulse mode is selected because it would hinder the receiving system to detect the flow direction out of the sequence of overlapping pulses.

4.8.2.2 Versatile Outputs 1 and 2 as Pulse Outputs

A pulse output configuration is used to indicate a [totalized] mass or volume. When a mass is to be indicated, the number of pulses per the specified mass unit (unit conversion applies) is set in registers VersDigOutCh0PlsMass (output 1) and VersDigOutCh1PlsMass (output 2). A value of 100000 will output 100000 pulses per mass unit. A constant mass flow of one mass unit per minute thus will result in an averaged pulse frequency of $100000 \times 1/60 = 1666$ pulses per second. Please review the notes in section 4.8.5 regarding the maximum output frequency supported by the outputs and other output factors when determining pulse output settings.

Similarly, a volume configuration requires the number of pulses for one volume unit to be set in the VersDigOutCh0PlsMass (output 1) or VersDigOutCh1PlsMass (output 2) registers.

Pulse outputs can be configured for forward or reverse flow.

The versatile outputs can also be configured to operate together with different phasing. In this configuration, output 2 is set to pulse at the same rate as output 1, except with a 90° phase shift in relation to output 1 when flow is in the positive direction, and a 270° phase shift when flow is in a negative direction. When setting up output 1 in this mode, output 2 is not available and any setup for it will be ignored.

Pulse outputs can be configured and set using the “Configuration” / “Digital Output Configuration” submenu, the channel selection found therein and the “Pulse Output” menu items, or in the “Digital Output” setup configuration tab in the Configuration window, of the RHEComPro Software.

When configured via the menus a dialog box like the one shown in Figure 19 or Figure 20 below will appear:

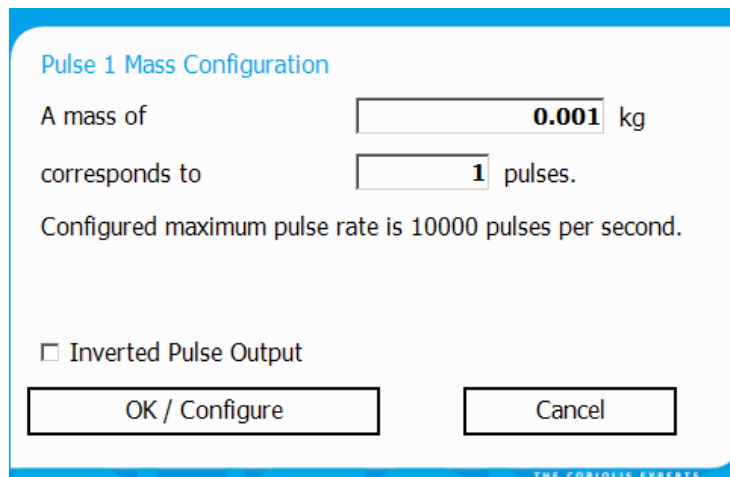

Figure 19: Pulse Output Configuration Dialog Box.

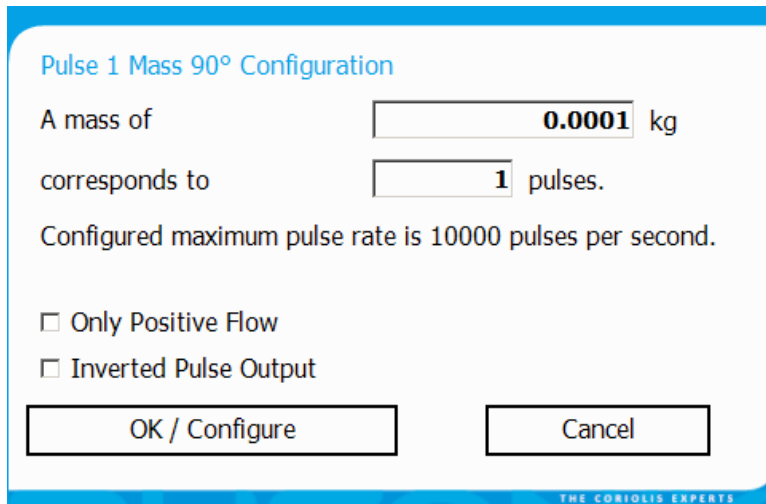

Figure 20: Pulse Output Configuration Dialog Box For 90° Configuration.

This dialog box provides fields to enter a mass value and the corresponding number of pulses required for that mass value. The number of pulses in the lower field is initially set to 1 and may be set to a different number, e.g. to 1000 or 600000 (see examples below) as needed to provide the correct pulse to mass/volume relationship.

The pulse rate should be configured such that the maximum flow rate of the sensor does not surpass 10000 pulses per second. This can be checked using this formula:

$$\text{Minimum Mass/Volume Setting} = (\text{Max Application Flow Rate per second}) / 10000$$

Examples:

For an RHM12 sensor with a maximum flow rate of 100kg/min the specified mass in the first input field should not be less than

$$0.0001666666 \text{ kg} = (100 / 60) / 10000 \text{ kg}$$

or

$$0.0003666667 \text{ lb} = (220 / 60) / 10000 \text{ lb}$$

assuming a pulse reference of 1. The same specification could be given by setting the mass to 100kg (220lb) and the pulse reference to 600000 (maximum pulses per minute). Since the mass or volume specification is subject to a unit conversion the specified mass or volume in the first input field must be in accordance with the indicated unit.

Since 32-bit floating point numbers are used to store the setup values, minor rounding errors around the 6th decimal digits have to be expected, see also the discussion in section 2.2.4.

It is also possible to invert the signal level on the respective output. When this is desired the check box “Inverted Pulse Output” must be activated (checked). When a 90° configuration is chosen it is possible to specify that a reverse flow is to be ignored. Otherwise, a reverse flow would lead to a 270° pulse output sequence.

The configuration is transferred to the RHE transmitter setup parameter set when the “OK/Configure” button is pressed.

When the dual pulse mode is selected for output 1, i.e. VersDigOutCh0Config (0x6D06) contains 2 or 3, the pulses on output 1 are also outputted on output 2 with a defined phase shift of 90°. This is used by certain billing systems to ascertain the correct transmission of mass or volume information.

When the transmitter detects a fatal error, see section 6.1, the pulses on output 2 are suppressed, but continued on output 1 in order to signal this failure to the receiving system.

4.8.2.3 Slow Pulse Mode

When the pulse modes 1, 2, 5, 6 or 15 to 18 is configured in VersDigOutCh0Config (0x6D06) for digital output 1 or in VersDigOutCh1Config (0x6E06) for digital output 2 the value 0 in the respective maximum pulse rate register VersDigOutCh0MaxPulse (0x6D00) resp. VersDigOutCh1MaxPulse (0x6E00) configures the Slow Pulse Mode using a maximum pulse rate to 50 Hz.

In this mode every 10ms is decided whether the totalizer increment is sufficient to output a single edge. This may cause the output of very slow pulses which do not necessarily have a 50% duty cycle. It, however is guaranteed that the output keeps its state for at least 10ms resulting in a maximum frequency of 50 Hz.

Since a totalizer is incremented every four oscillation cycles of an RHM sensor a configuration of the digital output in this mode may be adapted to output much slower pulses when the pulse rate specification parameter in VersDigOutCh0PlsMass (0x6D08) resp. in VersDigOutCh1PlsMass (0x6E08) is set to a value greater than

$$\text{RHM_MaxFlow [kg/min]} / (60 [\text{s}] * \text{RHM_Frequency} / 4)$$

For an RHM04 in parallel configuration with a maximum flow of 10.0 kg/min and an oscillation frequency of 225 Hz the selection of the value 0.010 kg/pulse in a VersDigOutChXPlsMass parameter will limit the maximum frequency below 17 Hz.

Note that pulses will outputted even after a flow stopped when due to a misconfiguration there are remaining pulses to be delivered to match the totalizer value.

4.8.2.4 Testing a Pulse Transmission Link

In an environment featuring a high electric noise level it is often necessary to test the transmission link from the RHE pulse output to an evaluation electronic. Using the pulse output test mode of a pulse channel and its associated pulse count register allows the determination of the exact number of pulses which were generated by the RHE and a comparison with the number of the pulses received by the evaluation electronic.

This is accomplished by following steps:

- Set a pulse output channel to a pulse mode, e.g. by setting VersDigOutCh0Config (0x6D06) to 1 for output 1 or VersDigOutCh1Config (0x6E06) to 1 for output 2. This step will need a reset of the RHE if the setting really has to be modified.
- Make sure that no mass flow occurs during this test e.g. by closing the respective valves.
- Also reset or note down the number of pulses received by the evaluation electronics.
- Write the number of pulses to be generated in a 10ms interval into VersDigOutCh0TestValue (0x6D04) for output 1 or VersDigOutCh1TestValue (0x6E04) for output 2. Use the number which corresponds to the maximum pulse rate you expected. For a pulse rate of 10 kHz this is 100. Setting test registers has an immediate effect and does not need a reset of the transmitter.
- Write the value 2 into the register VersDigOutCh0TestStart (0x6D02) for output 1 or VersDigOutCh1TestStart (0x6E02) for output 2. This also resets the contents of the pulse counter registers VersDigOuCh0PulseCount (0x4D02) resp. VersDigOuCh1PulseCount (0x4E02) to 0.

- Let the test run a while (less than 50 seconds, see remarks below) and then write 0 into the register VersDigOutCh0TestStart (0x6D02) for output 1 or VersDigOutCh1TestStart (0x6E02) for output 2 in order to stop the test.
- You find the number of pulses generated by the RHE in the pulse counter registers VersDigOuCh0PulseCount (0x4D02) resp. VersDigOuCh1PulseCount (0x4E02). These numbers can be compared directly to the number of pulses counted by the evaluation equipment. These numbers should be equal for a working transmission link.

Should this test not produce the expected results or return error codes when registers are modified following remarks may be helpful.

- This test needs the optional hard lock / custody transfer switch to be disabled.
- The pulse counter registers are of a 32-bit floating point type. These keep the exact count up to about 500000 (about 6 decimal digits). Beyond this limit the contents of the counter registers will be not exact any more. This limits a test duration at a pulse rate of 10 kHz to about 50 seconds.
- These registers are also reset when the totalizers are reset and thus may be used to monitor the number of pulses generated during a filling process at the RHE side and allow a subsequent comparison at the evaluation side provided the value in the counters are still in the exact range.
- In a dual channel 90° or 180° pulse configuration only the counter of output 1, VersDigOutCh0TestStart (0x6D02), is updated and contains the number of pulses generated for both channels. Just the test registers for output 1 must be set up in this case.

4.8.2.5 Versatile Outputs 1 and 2 as Frequency Outputs

The versatile digital outputs 1 and 2 can be used to indicate mass or volumetric flow rate or the measured density as a proportional varying frequency signal.

Since the base frequency is specified in number of pulses in a 10ms time span the value in the respective configuration register must be multiplied by 100 to yield a proper frequency number in Hz. Thus, a setting of 100 in VersDigOutCh0FreqReference (output 1) or VersDigOutCh1FreqReference (output 2) corresponds to a reference frequency of 10000 Hz.

Configuration for mass or volumetric flow requires the setting of two values, frequency in register VersDigOutCh0FreqReference (output 1), VersDigOutCh1FreqReference (output 2) and a mass/volumetric flow value that corresponds to this frequency in either register VersDigOutCh0FreqMassFlwRt (mass) or VersDigOutCh0FreqVolFlwRt (volume) (output 1), VersDigOutCh1FreqMassFlwRt (mass) or VersDigOutCh1FreqVolFlwRt (volume) (output 2).

When density is selected for frequency output, the registers VersDigOutCh0FreqReference and VersDigOutCh0FreqDensity (output 1), VersDigOutCh1FreqReference and VersDigOutCh1FreqDensity (output 2) are to be set to the desired reference frequency and associated density. When these registers are set to 10000Hz and 2000 kg/m³ for example a measured density of 800 kg/m³ will result in an output frequency of

$$10000 \text{ Hz} * 800 \text{ kg/m}^3 / 2000 \text{ kg/m}^3 = 4000 \text{ Hz}$$

Three frequency output modes are available:

Slow update mode: the output frequency is calculated once every second from the underlying live measurement value. The resulting output frequency is constant for at least one second. In this mode a measurement of the time span between two or more pulses gives a good indication of the

underlying live measurement value up to a resolution of 1/10000 of the measured value (depending on the configured maximum pulse count).

Fast update mode: the output frequency is determined every 10ms. Since only whole pulses can be output, the basic resolution is limited to 100 updates per second which corresponds to a full scale resolution of 1%. The resolution can be increased on the input side by calculating mean values over a defined time span. An internal fractional pulse accumulator makes sure that a mean over several 10ms periods really makes sense and in fact allows the increase of the resolution. In this mode fast changes may be observed and the users can chose the resolution and the response time to changes to their needs.

Note, that the use of the Slow and Fast update modes are not recommended any more, see also the introduction in section 4.8.2.

RHE01-RHE14 Compatibility Modes: These modes were introduced to support customers which require a more uniform low to medium output frequency in the range of 200 to 4000 Hz which also closely monitors the transferred mass or volume. Frequencies up to 10000 Hz are possible but with a loss of resolution. For high frequencies the other frequency modes should be chosen.

Note: The RHE01-14 compatibility mode has an implied cut-off limit of 25 Hz since lower frequencies cannot be generated. Ideally, the configured Cut-Off limit in Modbus register 0x6924 should be larger than the mass flow representing a 25 Hz frequency output. Otherwise, a small mass flow could occur which is not reflected by the frequency output. E.g. a Cut-Off limit of 0.05 kg/min should be matched with a frequency output specification of 10000 Hz for 20 kg/min mass flow:

$$(10000 \text{ Hz} / 25 \text{ Hz}) * 0.05 \text{ kg/min} = 20 \text{ kg/min}$$

This implies a dynamic range of 400:1 which may be slightly less than the dynamic range an RHM sensor can be operated in. A similar relationship exists between the Cut-Off limit and the frequency output configured for volumetric flow in the compatibility mode.

When configured using the “Configuration” / “Digital Output Configuration” followed by the interface and the function selection a dialog box like the one shown in Figure 21 below will appear:

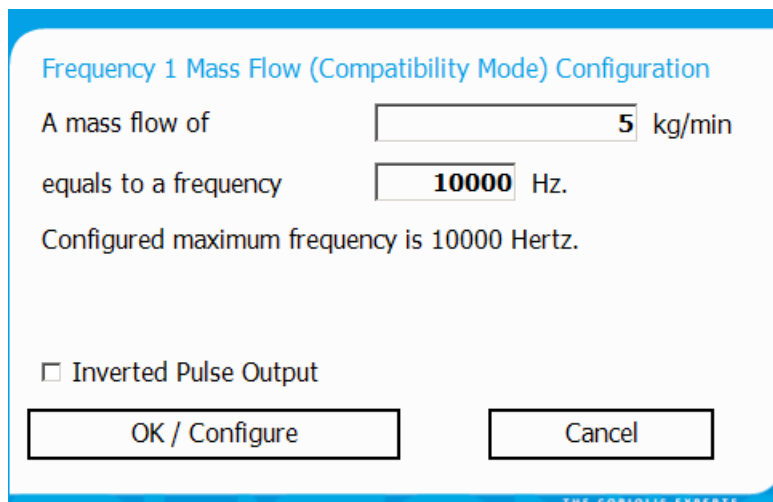

Figure 21: Frequency Output Configuration Dialog Box.

This dialog box provides fields to enter a mass or volume value and its corresponding frequency output. The maximum output frequency allowed 10000 Hz.

It is also possible to invert the signal level on the respective output. When this is desired the check box “Inverted Pulse Output” must be activated (checked).

The configuration is transferred to the RHE transmitter setup parameter set when the “OK/Configure” button is pressed.

4.8.3 Test Modes for the Digital Outputs

Within the register set associated with the control of the digital outputs there are registers that can be used to simulate their open and closed states. When these registers are set, they have an immediate effect on the outputs. These settings are not stored in EEPROM and are to default upon system reset or power cycle. In RHEComPro, test registers are indicated with a light orange background.

Each digital output has two registers for test output purposes: DigOutCh0TestStart (0x6D18) and DigOutCh0TestValue (0x6D1A) for channel 0 (output 4), DigOutCh1TestStart (0x6E18) and DigOutCh1TestValue (0x6E1A) for channel 1 (output 3). Setting the TestStart registers to 1 enables test mode and the specific output is set to the value currently in the TestValue register. Changing the value in the TestValue register from 0 to 1 will turn the digital output on and vice versa. Returning the TestStart registers to 0 returns the outputs to the normal [as configured] operation.

4.8.4 Test Modes for the Versatile Digital Outputs

Within the register set associated with the control of the versatile outputs there are registers that can be used to drive test signals from the unit. When these registers are set, they have an immediate effect on the outputs. These settings are not stored in EEPROM and are to default upon system reset or power cycle. In RHEComPro, test registers are indicated with a light orange background.

The effect of the test values entered for outputs 1 and 2 depends upon the mode settings found in the VersDigOutCh0Config and VersDigOutCh1Config registers. When the contents of these registers specify a pulse output, the number of pulses specified in the registers VersDigOutCh0TestValue and VersDigOutCh1TestValue is output every 10ms for as long as the test mode is activated; the pulse value in the test registers multiplied by 100 will yield the number of pulses per second. As an example, a value of 50 in the register will result in 5000 pulses per second as an output.

When the frequency mode is set for outputs 1 and 2, the entered test value specifies the number of pulses in Hz, i.e. an entered test value of 5000 will result in 5000 pulses per second.

4.8.5 Notes on the Pulse / Frequency Outputs

Some notes on the pulse / frequency outputs:

- Except for the compatibility modes frequencies (fast) and pulses below 100Hz will not feature a 50% duty cycle. The time span for the low-cycle is limited to a maximum of 5ms. For the compatibility mode this limit is around 40ms or 25Hz.
- The maximum possible pulse output frequency is 10kHz (100 pulses in 10ms).
- Should signal distortions be too extreme a problem, it is recommended that the maximum pulse frequency be lowered by reducing the number of pulses allowed in any 10ms time span by adjusting the values in the VersDigOutCh0MaxPulse and VersDigOutCh1MaxPulse registers.
- The pulse output configuration should not be used to calculate a flow rate indication due to interferences between sensor frequency and the time slots in which the pulse output is handled. Use a versatile output in a frequency configuration in order to transfer a flow rate. For the same reason, a mass or volumetric totalization measurement should not be inferred from a frequency output.

- In standard pulse output configuration, no pulses are output when the flow direction reverses. Similarly, a pulse output in reverse output configuration will not output pulses for a positive flow.
- In the 90° pulse output configuration, a flow direction reversal causes the pulses of output 2 to be shifted to a 270° phase position. There is equipment in the market that can determine flow direction using the phasing of the pulse outputs.

4.9 Current Output Setup

Certain models of the RHE20 transmitter series can be ordered with one or two optional current outputs. The current outputs provides an industry standard 4 to 20mA signal for connection to local control and indicating instrumentation. The outputs can be configured to provide an output signal from any one of the following variables: mass flow rate, volume flow rate, measured density, or both measured sensor temperatures.

The MODBUS registers related to the current outputs are detailed in Appendix D.13.

Figure 22 below shows the “Current Output” setup configuration tab in the Configuration window of the RHEComPro Software for the first current output channel 1.

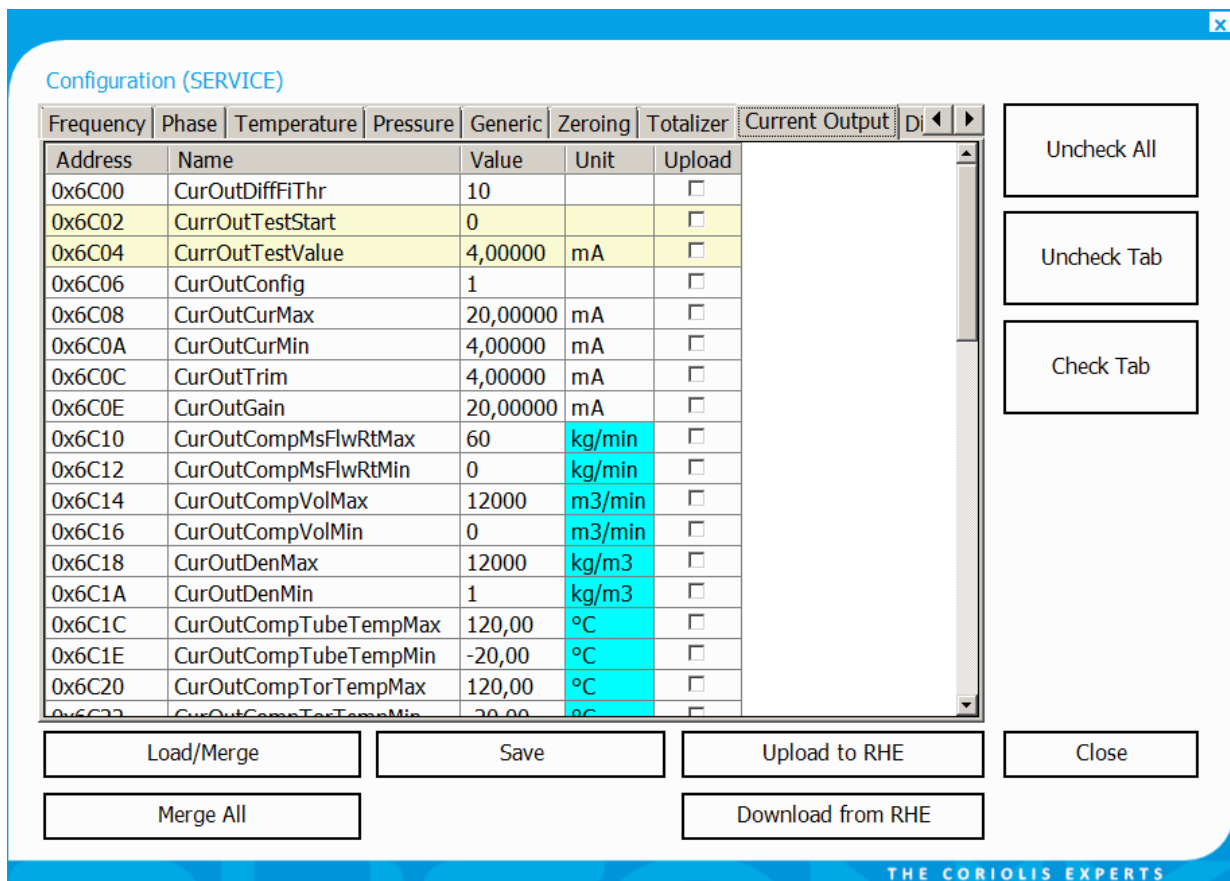

Figure 22: Current Output Tab of the Configuration dialog box.

The first current output interface at index 1 features parameters with names starting with “CurOut” in the address range of 0x6C00 to 0x6C32. The parameters of the second current output interface have names starting with “CurOut2” and are found in the address range of 0x6C40 to 0x6C72.

In the following subsections only the configuration of the first current output channel is described. Since both interfaces have the identical parameter sets this description also is valid for the second

current output channels when the start of the parameter names is replaced by “CurOut2” and the address of the respective register is incremented by 0x40 (decimal 64).

4.9.1 Modes of the Current Output

Selection of the measurement variable to be used with the current output is made in the CurOutConfig (0x6C06) register. Measurement variables that can be selected are

- mass flow rate
- volumetric flow rate
- density
- Meter tube temperature
- Torsion bar temperature
- Drive Gain
- Assurance Factor
- Percent Main Substance

Once the measurement variable is selected, minimum and maximum range values must be entered in the registers designated for the particular variable.

The relevant registers for the analog current output max/min values are:

Mass Flow	CurOutCompMsFlwRtMax (0x6C10)	CurOutCompMsFlwRtMin (0x6C12)
Volume Flow	CurOutCompVolMax (0x6C14)	CurOutCompVolMin (0x6C16)
Density	CurOutDenMax (0x6C18)	CurOutDenMin (0x6C1A)
Tube Temp.	CurOutCompTubeTempMax (0x6C1C)	CurOutCompTubeTempMin (0x6C1E)
Torsion Rod Temp.	CurOutCompTorTempMax (0x6C20)	CurOutCompTorTempMin (0x6C22)
Drive Gain	CurOutGainMax (0x6C2C)	CurOutGainMin (0x6C2E)
Assurance Factor	CurOutAssuranceMax (0x6C34)	CurOutAssuranceMin (0x6C36)
Percent Main Substance	CurOutGainMax (0x6C2C)	CurOutGainMin (0x6C2E)

When a second analog output interface is present, the corresponding setup parameters are found in the Modbus holding register address range below 0x6C40 and the name of the parameters start with “CurOut2...”.

4.9.2 Setting Measurement Range

The minimum measurement value that corresponds to a nominal 4mA output is entered in the minimum register for the measurement variable. The maximum measurement value that corresponds to 20mA is entered in the maximum register for the variable. Should the measurement variable value go outside of these entered values, the output can be configured to respond in a certain way to indicate an alarm, or fire state. See section 4.9.3 for additional details.

Example of current output configuration:

The register CurOutConfig is set to specify density as the measurement variable for the current output. The density minimum register CurOutDenMin is set to 700.0kg/m³ and the density maximum register CurOutDenMax is set to 900.0kg/m³. When the measured density is 850kg/m³, the following current output is generated:

$$(850\text{kg/m}^3 - 700\text{kg/m}^3) * (20\text{mA} - 4\text{mA}) / (900\text{kg/m}^3 - 700\text{kg/m}^3) + 4\text{mA} = 16\text{mA}$$

4.9.3 Error Condition/Fire State Setting

If the measurement value goes outside of the user defined current output range, it is possible to control the behavior of the current output by defining an error condition, or fire state in the CurOutFireState (0x6C28) register.

By default, the CurOutFireState (0x6C28) register is set to clamp the current output at its maximum value (nominal 20mA) when the measurement variable exceeds the maximum current output range value and at its minimum value (nominal 4mA) when the measured variable is lower than the minimum current output range value.

The CurOutFireState (0x6C28) register can be set to drive the current output to a value outside of the nominal 4-20mA range should the measured variable leave the defined range or when the RHE transmitter signals an error in the SoftError (0x401C) or ErrorStatus (0x401A) registers. The current to drive to can be set as 22mA, 0mA, 2mA, 3.2mA, or 3.6mA. Transmitters of the RHE20 series will silently limit the minimum current to 3.2mA if the 0mA or 2mA options are selected and an alarm condition occurs.

4.9.4 Fast Current Output Configuration

When configured using the “Configuration” / “Analog Output Configuration” followed by a channel selection and a type selection a dialog box like the one shown in Figure 23 below will appear:

4-20mA Analog Output 1 Configuration: Mass Flow

Minimum Mass Flow at 4mA: kg/min

Maximum Mass Flow at 20mA: kg/min

Fire State Selector:

THE CORIOLIS EXPERTS

Figure 23: Analog Output Configuration Dialog Box.

This dialog box has fields for the current output maximum and minimum range values and a selector for the error/fire state condition if required. The configuration is transferred to the RHE transmitter setup parameter set when the “OK / Configure” button is pressed.

4.9.5 Output Damping

The change of the current output may be damped in addition to the damping done by filters in the measurement data path of the RHE transmitter. The damping of the current output only should be employed when it is really necessary for a controlling system which uses the output for its processing as the reaction time to any change is reduced by the damping. The damping is controlled by following Modbus holding registers:

Address	Name	Description
0x6C30	CurOutDampingTau	Time constant (Tau) of the current output damping in seconds. An exponential damping mechanism is used within a defined band, see CurOutDampingBand (0x6C32). When the output values leave the defined band the damping is disabled. A value of 0.0 disables the damping.
0x6C32	CurOutDampingBand	Defines the band range for the damping of the current output in percent of the range between CurOutCurMin (0x6C0A) and CurOutCurMax (0x6C08) 20mA. A value of 100 makes sure that the values never leave the band and that the damping always is active.

The damping registers of the second current output are located at addresses 0x6C70 resp. 0x6C72 and are named CurOut2DampingTau resp. CurOut2DampingBand.

When no damping is intended CurOutDampingTau has to be set to 0.0 and CurOutDampingBand should be set to 100.0.

The time constant Tau for the damping configuration can be set from 0.0 to 300.0 seconds. The parameter CurOutDampingBand can be used to speed up the reaction time to changes when the signal changes to the outside of the band in positive or negative direction as defined by the percentage in this register. When the band is left by the controlling signal no damping is performed and the output follows the controlling input. A value of 100 percent in CurOutDampingBand disables this feature.

4.9.6 PID Controller

Since firmware release 2.07 a PID Controller is available for RHEs ordered when the RHE transmitter is ordered with an option which includes the Assurance Factor feature (e.g. option codes AF, OG, and CT). The PID Controller is part of the Analog Output interface. Each of the Analog Output channels features a separately configurable PID Controller. In order to keep this document manageable the activation and the configuration of the PID Controller is described in a separate document "Addendum RHE2/4X Desktop Reference PID Control" with document number 8.2.1.30. Please ask the Rheonik Service for a copy should it not be available for download at the rheonik.com web pages.

4.9.7 Tests and Calibration

When delivered the current outputs of the RHE transmitter are already calibrated. The calibration option may be used during the installation of a system to accommodate the need to trim inaccuracies in instruments and systems it is connected to.

More information can be found in Appendix D.13. The current output setup offers two test registers, CurrOutTestStart (0x6C02) and CurrOutTestValue (0x6C04). A write to these registers immediately takes effect and resets to their default values upon reset or power cycle. When the value 1 is written to CurrOutTestStart, the value in CurrOutTestValue is used to generate a corresponding output current in mA. This test sequence can be used to calibrate the current output:

1. Write the value 4.0 into CurrOutTestValue and 1 into CurrOutTestStart. The actual current seen/measured at the connected equipment is entered into register CurOutTrim (0x6C0C).
Example:

The measured value is 3.92mA and thus the value 3.92 should be written to CurOutTrim (0x6C0C).

2. Write the value 20.0 into CurrOutTestValue and 1 into CurrOutTestStart. The current seen/measured at the connected equipment is entered into the register CurOutGain (0x6C0E).

Example:

The measured value is 20.6mA and thus the value 20.6 should be written to CurOutGain (0x6C0E).

After the calibration has been carried out, its effect can be tested by writing the value 2 to the register CurrOutTestValue. In this mode, the calibration factors CurOutGain and CurOutGain are applied to the test value in the CurrOutTestValue register before the output current is generated. After calibration, the output current should be validated at several values in the 4-20mA range.

Writing the value 0 to the CurrOutTestStart register will immediately terminate the test mode and make the current output live again.

4.10 Analog Inputs, Pressure, Density, or External Temperature Measurement

Depending on the model and ordering options an RHE transmitter may feature a 4-20mA analog input to which a pressure sensor, a density sensor, or an external temperature sensor may be attached. The attached sensor must feature the respective analog output.

The presence of a live pressure measurement may be used to enhance the precision of the mass flow measurement further especially when the pressure is not constant during the measurements.

All parameters needed to configure the analog input and its attached sensor are found in the "Pressure" parameter group even for an attached density sensor.

The type of the attached sensor is determined by the value PressureCalcConfig (0x6610), see Appendix D.8.1.1. This parameter also determines the origin of the temperature value used for the API MPMS density calculation.

In the following subsections the calibration of the Analog Input and the configurations for a pressure sensor or a density sensor are described.

4.10.1 Calibration of the Analog Input

The Analog Input is pre-calibrated at the factory. This calibration may be adapted to the specific output range of a sensor. This is best be done with the help of the RHEComPro program and following Modbus input and holding registers:

Address	Name	Description
0x6618	AdcCalOffset	Calibration setting for the ADC offset. During the calibration of the 4-20mA interface this value should be taken from AdcPrsRaw (0x4600) when a 4mA current is applied to the interface. The allowable range corresponds to 2.0 to 6.0mA converted into ADC units.
0x661A	AdcCalGain	Calibration setting for the ADC gain. During the calibration of the 4-20mA interface this value should be taken from AdcPrsRaw (0x4600) when a 20mA current is applied to the interface. The allowable range corresponds to about 16.0 to 24.0mA converted into ADC units.
0x4602	AdcPrsMean	Filtered measurement value in ADC units.

In a first step the analog output of the sensor has to be forced to a constant 4mA output. This could be achieved e.g. with the help of a HART® communication and the respective commands. The corresponding RHE-internal ADC value is read out of the AdcPrsMean input register (0x4602) and has to be written to the AdcCalOffset (0x6618) holding register. Expected values are in the range of 5000 to 6000.

In a second step the analog output of the sensor has to be forced to a constant 20mA output. Again the corresponding RHE-internal ADC value is read out of the AdcPrsMean input register (0x4602)

and this time has to be written to the AdcCalGain (0x661A) holding register. Expected values are in the range of 28000 to 30000.

When the values are not in the expected ranges the currents should be measured to confirm that the sensor (or the current reference) works correctly.

In a last step the modified parameters have to be uploaded into the RHE transmitter which automatically will commit the new parameters and cause a transmitter reset when done with the help of the RHEComPro program.

4.10.2 Parameterization for Pressure Input

When a pressure sensor is attached to the Analog Input following Modbus holding and input registers are used for its configuration:

Address	Name	Description
0x6604	PrsValMin	Pressure Operating Range Minimum. This depends on the pressure sensor and defines the pressure value at a nominal 4mA current. This value based on the unit specified pressure unit conversion register (0x6102). Range is from -1100.0 to +5000000 hPa.
0x6606	PrsValMax	Pressure Operating Range Maximum. This depends on the pressure sensor and defines the pressure value at a nominal 20mA current. This value is converted into the unit specified pressure unit conversion register (0x6102). Range is from 0.0 to +5000000 hPa.
0x660E	PrsOffset	The defined Pressure Offset will be added to the measured pressure to yield PrsCurr (0x4604) and PrsMean (0x4606). This value is intended to be used to convert a relative pressure into absolute pressure. Default is 0.0. This value is converted into the unit specified pressure unit conversion register (0x6102). Range is from -1100.0 to +5000000 hPa.

Address	Name	Description
0x6610	PressureCalcConfig	<p>Configuration of Pressure Calculation: This parameter controls the origin of the pressure and temperature data used for the API MPMS density calculation. For following values the temperature for the API MPMS calculation is taken from the tube temperature (AdcTubeMeanTemp [0x4500]):</p> <p>0: Pressure measurement and calculation is switched off. 1: Pressure is always taken from the PrsExternalCurrent register (0x6620) which may be updated any time by the user. Its initial value can be set during the installation of the system in PrsExternalInitial (0x6612). 2: An absolute pressure sensor is attached to the 4-20mA input. 3: A relative pressure sensor is attached to the 4-20mA input.</p> <p>For the following value the temperature for the API MPMS calculation is taken from the analog input and the pressure is taken from the PrsExternalCurrent register (0x6620):</p> <p>4: A temperature sensor is attached to the 4-20mA input.</p> <p>For following value the temperature for the API MPMS calculation is taken from ExtTemperatureCurr (0x6630) and the pressure is taken from the PrsExternalCurrent register (0x6620):</p> <p>5: External data is used for temperature and pressure.</p> <p>For following value the temperature for the API MPMS calculation is taken from ExtTemperatureCurr (0x6630) and the pressure is taken from analog input:</p> <p>6: An absolute pressure sensor is attached to the 4-20mA input. 7: A relative pressure sensor is attached to the 4-20mA input.</p> <p>Note, that a density sensor also may be attached to the 4-20mA input when DnsConfig (0x6800) is set to 4. In this case the registers AdcRawMin (0x6600), AdcRawMax (0x6602), AdcFilNoSamples (0x6608), AdcCalOffset (0x6618), AdcCalGain (0x6620), DnsValMin (0x6622), and DnsValMax (0x6624) are used for the density measurement and must be set accordingly. A DnsConfig (0x6800) value of 4 takes precedence over a PressureCalcConfig value of 2 to 4 and 6 to 7.</p>
0x4606	AdcPrsMean	Filtered measurement value in pressure units as defined by the pressure unit conversion specification (0x6102).

In a first step PressureCalcConfig (0x6610) has to be set to 2, 3, 6 or 7 depending on the type of the sensor and the origin of the temperature data of the API MPMS density calculation. Then the lower range of the pressure sensor has to be set in PrsValMin (0x6604). This pressure has to correspond to a nominal 4mA output of the pressure sensor.

The upper range of the pressure sensor has to be set in PrsValMax (0x6606). This pressure has to correspond to a nominal 20mA output of the pressure sensor.

Usually PrsOffset (0x660E) is set to 0 even for a relative pressure sensor unless the range defined in PrsValMin and PrsValMax does not take the reference pressure into account. In this case the reference pressure has to be written into PrsOffset.

After the upload of the parameterization the measured pressure can be observed and checked in the AdcPrsMean (0x4606) input register.

Further parameters allow the definition of a warning range for the pressure by the user and the definition of an input filter size which is used to determine the mean pressure value.

4.10.3 Parameterization for Density Input

When a density sensor is attached to the Analog Input following Modbus holding and input registers are used for its configuration:

Address	Name	Description
0x6622	DnsValMin	Density Operating Range Minimum used when DnsConfig (0x6800) is set to 4. This depends on the pressure sensor and defines the pressure value at a nominal 4mA current. This value is based on the unit specified density unit conversion register (0x6108). Range is from 0.0 to 12000 kg/m3.
0x6624	DnsValMax	Density Operating Range Maximum used when DnsConfig (0x6800) is set to 4. This depends on the density sensor and defines the density value at a nominal 20mA current. This value is based on the unit specified density unit conversion register (0x6108). Range is from 0.0 to 12000 kg/m3.
0x6800	DnsConfig	<p>Density Configuration: Type of density measurement: 0: Off 1: Density is calculated from sensor data. 2: Density is set to the value found in the updateable VolFlwNorDensCurr (0x6838) register which in turn is initialized from the VolFlwNorDens (0x6832) setup register. No temperature compensation is applied. 3: The temperature corrected density based in the value in the VolFlwNorDens (0x6832), the RHM tube temperature, the density reference temperature dnsRefTmpNorDns (0x6834), and the expansion factor dnsTmpCoeff (0x6836) is used. Density is calculated by the following formula:</p> $DenComp = \frac{VolFlwNorDens}{(1 + dnsTmpCoeff(AdcTubeMeanTemp - dnsRefTmpNorDns))}$ <p>in which °C representation of temperature is used.</p> 4: A density sensor is attached to the 4-20mA Input. In this case the registers AdcRawMin (0x6600), AdcRawMax (0x6602), AdcFilNoSamples (0x6608), AdcCalOffset (0x6618), AdcCalGain (0x6620), DnsValMin (0x6622), and DnsValMax (0x6624) in the "Pressure" register group are used for the density measurement and must be set accordingly. A DnsConfig (0x6800) value of 4 takes precedence over a PressureCalcConfig (0x6610) value of 2 or 3.
0x4806	DenComp	Filtered measurement value in pressure units as defined by the pressure unit conversion specification (0x6102).

In a first step DnsConfig (0x6800) has to be set to 4. Note that the pressure calculation mode 1 in PressureCalcConfig still is available when this is done.

Then the lower range of the density sensor has to be set in DnsValMin (0x6622). This density has to correspond to a nominal 4mA output of the density sensor.

The upper range of the density sensor has to be set in DnsValMax (0x6624). This density has to correspond to a nominal 20mA output of the density sensor.

After the upload of the parameterization the measured density can be observed and checked in the DenComp (0x4806) input register.

An additional parameter allows the definition of an input filter size which is used to determine the mean density value in AdcFilNoSamples (0x6608).

4.10.4 Parameterization for External Temperature

When the API MPMS Density calculation is employed the temperature on which the volume calculation is based can be determined by an external temperature sensor attached to the Analog Input interface. By default the tube temperature is used for this purpose.

When a temperature sensor is attached to the Analog Input following Modbus holding and input registers are used for its configuration:

Address	Name	Description
0x6626	ExtTempValMin	External Temperature Operating Range Minimum: (Since Release 2.06) Temperature Operating Range Minimum used when PressureCalcConfig (0x6610) is set to 4. This depends on the temperature sensor and defines the pressure value at a nominal 4mA current. This value is based on the unit specified by the temperature unit conversion register (0x6100). Range is from -270.0 to 420°C.
0x6628	ExtTempValMax	External Temperature Operating Range Maximum: (Since Release 2.06) Temperature Operating Range Maximum used when PressureCalcConfig (0x6610) is set to 4. This depends on the temperature sensor and defines the temperature value at a nominal 4mA current. This value is based on the unit specified by the temperature unit conversion register (0x6100). Range is from -270.0 to 420°C.
0x460A	ExtTemperature	External Temperature: (Since Release 2.06) Current External Temperature at the 4-20mA input for API MPMS correction. This value is set to the tube temperature when PressureCalcConfig (0x6610) is not set to 4. The unit of this register is defined by the temperature conversion register TemperatureUnit (0x6100).

In a first step PressureCalcConfig (0x6610) has to be set to 4.

Then the lower range of the temperature sensor has to be set in ExtTempValMin (0x6626). This temperature has to correspond to a nominal 4mA output of the density sensor.

The upper range of the temperature sensor has to be set in ExtTempValMax (0x6628). This temperature has to correspond to a nominal 20mA output of the density sensor.

After the upload of the parameterization the measured temperature can be observed and checked in the ExtTemperature (0x4808) input register.

An additional parameter allows the definition of an input filter size which is used to determine the mean temperature value in AdcFilNoSamples (0x6608).

4.11 Digital Inputs

Depending of the model and the ordering options an RHE transmitter may feature one or two digital inputs. These inputs may be configured to start the zeroing process or to reset or stop the totalizers in the transmitter. The latter functionality is intended to facilitate a batch filling mode where the activation of a button starts the next filling process.

The parameters controlling the digital inputs of the RHE transmitter are found in the "HMI" parameter group:

Address	Name	Description
0x6F0A	DI1Property	<p>Functionality of Digital Input 1:</p> <ul style="list-style-type: none"> 0: DI1 is disabled. All inputs are ignored (default). 1: DI1 causes the start of a Zeroing Process. Logic is positive – a transition to a high logic level starts the Zeroing. 2: Start Zeroing: Same as 1 but with inverted DI1 polarity. 3: DI1 causes reset of the Totalizers and the start of Batch Processing if configured, see Batch Mode (0x6F0E). Logic is positive – a transition to a high logic level starts the Batch. This also undoes the effects of the Batch Hold command, see values 9 and 10. 4: Reset Totalizers: Same as 3 but with inverted DI1 polarity. 5: A transition from low to high at DI1 stops the totalizers when they are in the running state. A transition from high to low at DI1 restarts the totalizers when they are in the stopped state. 6: Totalizers Stop/Start: Same as 3 but with inverted DI1 polarity. 7: Special functionality 1 started by transition from low to high and stopped at a transition from high to low. See extra document 8.2.1.11. 8: Special functionality 1: Same as 7 but with inverted DI1 polarity. 9: Batch Hold/Alarm override: a transition from low to high inverts all DOs which are configured for batch mode (DigOutChXConfig is 7 or 8 and DigOutChXAlmType is 1 or 2) and their upper alarm limit is not yet reached. This can be used to close the valves attached to the digital outputs. This is compatible to the RHE07 Batch Stop function. 10: Batch Hold/Alarm override: Same as 9 but with inverted DI1 polarity. 11: Batch Restart: a transition from low to resets the alarm override all DOs which are configured for batch mode (DigOutChXConfig is 7 or 8 and DigOutChXAlmType is 1 or 2). The totalizers are reset as well, when the batch filling limit has been surpassed as functions 3 and 4. This is compatible to the RHE07 Batch Start function. 12: Batch Restart: Same as 11 but with inverted DI1 polarity.

Address	Name	Description
0x6F0C	DI2Property	<p>Functionality of Digital Input 2:</p> <p>0: DI2 is disabled. All inputs are ignored (default).</p> <p>1: DI2 causes the start of a Zeroing Process. Logic is positive – a transition to a high logic level starts the Zeroing.</p> <p>2: Start Zeroing: Same as 1 but with inverted DI2 polarity.</p> <p>3: DI2 causes reset of the Totalizers and the start of Batch Processing if configured, see Batch Mode (0x6F0E). Logic is positive – a transition to a high logic level starts the Batch. This also undoes the effects of the Batch Hold command, see values 9 and 10.</p> <p>4: Reset Totalizers: Same as 3 but with inverted DI2 polarity.</p> <p>5: A transition from low to high at DI2 stops the totalizers when they are in the running state. A transition from high to low at DI2 restarts the totalizers when they are in the stopped state.</p> <p>6: Totalizers Stop/Start: Same as 3 but with inverted DI2 polarity.</p> <p>7: Special functionality 1 started by transition from low to high and stopped at a transition from high to low. See extra document 8.2.1.11.</p> <p>8: Special functionality 1: Same as 7 but with inverted DI2 polarity.</p> <p>9: Batch Hold/Alarm override: a transition from low to high inverts all DOs which are configured for batch mode (DigOutChXConfig is 7 or 8 and DigOutChXAlmType is 1 or 2) and their upper alarm limit is not yet reached. This can be used to close the valves attached to the digital outputs. This is compatible to the RHE07 Batch Stop function.</p> <p>10: Batch Hold/Alarm override: Same as 9 but with inverted DI2 polarity.</p> <p>11: Batch Restart: a transition from low to resets the alarm override all DOs which are configured for batch mode (DigOutChXConfig is 7 or 8 and DigOutChXAlmType is 1 or 2). The totalizers are reset as well, when the batch filling limit has been surpassed as functions 3 and 4. This is compatible to the RHE07 Batch Start function.</p> <p>12: Batch Restart: Same as 11 but with inverted DI2 polarity.</p>

As it can be seen the polarity of the input can be selected either way and may be adjusted by the parameter. The configuration of a batch filling mode is described in section 4.12.

4.12 Batch Filling Mode

In order to simplify the complex interaction of setup parameters there is a dedicated batch configuration window in the RHEComPro software, as well as a Batch Operation menu in the HMI of the RHE display since firmware release 2.30. Both interfaces guide the user through the setup of the respective parameters and only require the input of necessary parameters.

Note, that the last input item of the HMI Batch Operation menu must be confirmed via the Enter key in order to complete the modification of the setup parameter set related to batching. When parameters are modified the user is asked to activate the new settings via a parameter commit followed by an RHE reset operation.

Also note that the configuration of the digital outputs selected for valve control will be reconfigured from a pulse or frequency output to a status output.

The following chapters detail the parameters related to the batching operation in case non-standard requirements ask for a non-standard parameter configuration. With the help of the descriptions therein the parameters established by the standard setup functionality may be controlled and optimized if needed.

4.12.1 Simple Batch Filling Configurations

A simple batch mode for filling containers with defined masses or volumes can be configured without using the special batch mode parameters in the “HMI” parameter group. These parameters are needed only for the automatic adjustment of the amount of transferred substances, see section 4.12.2.

For the simple batch mode the parameter BatchMode (0x6F0E) should be set to its default value 0. The batch mode can be configured by defining the appropriate parameter values for the Digital Inputs and Digital Outputs.

The HMI at the display can be used to monitor the filling and cause a totalizer reset with the help of the keys at the display. This can be achieved by setting the default presentation screen to the Batch Mode Screen (value 7 in DefaultScreen [0x6F1A]).

Usually, at least one of the Digital Inputs is connected to a button which is used to start the filling. This input has to be configured to reset the totalizers when it activated. Depending on the logic or polarity of the connection button the values 3 or 4 have to be set for the property parameter, DI1Property (0x6F0A) for Digital Input 1 or DI2Property (0x6F0A) for Digital Input 2. When configured properly pressing the button will zero the totalizers.

This can be used to control at least one filling valve which is controlled by one of the digital outputs. The configuration parameter (DigOutCh0Config, DigOutCh1Config, DigOutChAConfig, or DigOutChBConfig) of the chosen digital output has to be set to the value 7 for a mass or 8 for a volume controlled filling. The alarm type parameter of this output (DigOutCh0AlmType, DigOutCh1AlmType, DigOutChAAlmType, or DigOutChBAlmType) must be set to 1 or 2 depending on the polarity of the valve control. In principle the lower alarm limit of the digital output could be set to 0, but it may make sense to set it to a small negative number which will allow for a temporary small reverse flow due to valve characteristics.

The upper alarm limit of the output (DigOutCh0AlmHigh, DigOutCh1AlmHigh, DigOutChAAlmHigh, or DigOutChBAlmHigh) must be set slightly below the target mass or target volume. The difference to the target value depends on the reaction time of the valve and other characteristics of the filling mechanism and must be tuned. Note that the alarm limits of the digital outputs only offer the units kg for mass or m³ for volume data. Any amount based on a custom unit must be converted to these units before the parameter value is set for the RHE transmitter.

Since firmware release 2.17 the limit registers for a digital output X (X=0, 1, A, or B), DigOutChXAlmHigh and DigOutChXAlmLow, are used to set the initial values for the registers DigOutChXAlmHighCurr and DigOutChXAlmLowCurr which are found in the Modbus address range immediately below the respective DigOutChXAlmHigh register. A write to these new DigOutChXAlmHighCurr and DigOutChXAlmLowCurr will have an immediate effect on the internal evaluation of the state for the respective digital output. Thus, e.g. the target mass of a batch filling application may be updated before the filling is started and no commit and reset operation is required.

Also since firmware release 2.17 a snapshot of the current values of the forward totalizer (TotalMassFwd, 0x4B00) and the mass flow (MassFlowRate, 0x4900) is stored in the registers BatchTotalSnapshot (0x4F0E) and BatchMassFlowSnapshot (0x4F10) respectively when a digital output used for batching (DigOutChXConfig is 7 or 8) transitions to another state. This will freeze the state of the current forward totalizer and the current mass flow at the moment when a valve is closed and may be used to observe the difference to the forward totalizer when the filling is concluded in order to obtain the transferred mass after the valve close command. Note that this

snapshot also may happen when the totalizer is cleared and the digital output transitions its state again. Thus, this register should be read after the conclusion of the filling before any other activities are initiated.

Two outputs with a slightly different setting of the respective upper alarm limits can be used to control two different valves, one for a coarse and another one for a fine control of the flow. Since the snapshots mentioned above are done whenever a digital output transitions its state the values in the snapshot registers will preserve the state at the moment when the fine valve is closed.

Furthermore, a system reaction time parameter can be used to dynamically control the timing of the end of the filling process depending on the current flow, see section 4.12.3.

4.12.2 Automatic Filling Support

The automatic filling mode is used to automatically determining the amount of substance where the valve has to be switched off in order to obtain the target filling. For this mode the digital inputs have to be configured as described in section 4.12.1. The digital output which controls the valve is restricted to Digital Output 3 (DIR) for which all related parameters names start with “DigOutCh1”. The respective parameters also have to be set to the basic configuration described in the previous section.

Following additional parameters must be configured:

Address	Name	Description
0x6F0E	BatchMode	<p>Batch Mode:</p> <p>0: Fixed Batch Control. Behavior depends solely on the configuration of the DIs (Properties 0x6F0A and 0x6F0C) and DOs (DigOutChXConfig 0x6D1C, 0x6D34, 0x6E1C, 0x6E34, and the DigOutChXAlmType 0x6D1E, 0x6D36, 0x6E1E, 0x6E36 and the respective limits.).</p> <p>1: Reserved. Currently the same as 0.</p> <p>2: Automatic Batch Mode via Forward Mass Totalizer. The transmitter automatically adjusts the control of the digital output channel 1 (DIR, DO3) to the target mass total specified in register BatchTargetMass (0x6F10). The parameter DigOutCh1Config (0x6E1C) must be set to 7 (Mass Total). Otherwise a batch mode configuration error is signaled in bit 12 of the ErrorStatus (0x401A) register. The parameter DigOutCh1AlmType (0x6E1E) controls the polarity of the output DIR/DO3. Other digital output channels may be configured to control a course mass flow which is taken into account by the automatic batch control, but the correct configuration of these outputs is the responsibility of the user.</p> <p>3: Automatic Batch Mode via Forward Volume Totalizer. The transmitter automatically adjusts the control of the digital output channel 1 (DIR/DO3) to the target volume total specified in register BatchTargetVol (0x6F12). The parameter DigOutCh1Config (0x6E1C) must be set to 8 (Volume Total). Otherwise a batch mode configuration error is signaled in bit 12 of the ErrorStatus (0x401A) register. The parameter DigOutCh1AlmType (0x6E1E) controls the polarity of the output DIR/DO3. Other digital output channels may be configured to control a course volume flow which is taken into account by the automatic batch control, but the correct configuration of these outputs is the responsibility of the user.</p> <p>4: Same as 0.</p> <p>5: Same as 1.</p> <p>6: Same as 2.</p> <p>7: Same as 3.</p>

Address	Name	Description
0x6F10	BatchTargetMass	Target Mass for the automatic control of the Batch Mode 2. Default is 1kg. This value is converted according to the MassUnit (0x6104) unit conversion specification.
0x6F12	BatchTargetVol	Target Volume for the automatic control of the Batch Mode 3. Default is 0.001 m ³ . This value is converted according to the VolumeUnit (0x610C) unit conversion specification.
0x6F14	BatchControlRange	Specifies the target range in which the automatic batch control algorithm switches from a coarse approximation to a fine control loop and vice-versa. This parameter is specified in percent. The default is 0.5%.

When the filling is done based on mass data the parameter BatchMode (0x6F0E9) must be set to 2 and the parameter BatchTargetMass (0x6F10) has to be set to the exact target mass.

For volume data based fillings it has to be set to 3 and the parameter BatchTargetVol (0x6F12) has to be set to the exact target volume.

Before a test filling sequence is started the high alarm level of the Digital Output 3 in DigOutCh1AlmHigh should be set slightly below the target mass or volume. The adaption of the BatchControlRange parameter also should be considered depending of the desired target precision and the precision of the filling mechanism.

During a sequence of fillings the RHE transmitter always compares the resulting mass or volume with the target values when the next filling is started. It then calculates the next alarm high value for Digital Output 3 out of the difference and stores it in DigOutCh1AlmHigh (0x6E22). The calculation is controlled by the BatchControlRange parameter. When the filling result falls in the range defined by this parameter a fine adjustment is done, otherwise a more coarse adjustment is performed.

As described above the updated target control loop value is stored in DigOutCh1AlmHigh (0x6E22). Usually, this updated value is lost when a power cycle or a system reset is performed for the RHE transmitter. Therefore, it is recommended to commit the current parameter set to the NWM after a small number of successful test fillings. This can be achieved by entering the “User Setup” menu on the local HMI and exiting this immediately with the ESC key. The parameter commit request then has to be confirmed.

4.12.3 Additional Batch-Related Functionality

Since Release 2.06 the configuration of the Digital Inputs (see section 4.11) has been amended to include the possibility to halt a filling via a DI functions 9 or 10. This overrides the state of the DOs involved in the filling process in order to close the attached valves. This function does not stop or affect the totalizers and is compatible with the RHE07 Batch Stop function.

DI functions 11 or 12 undo this override effect and conditionally restart the totalizers when the previous filling has been concluded. This function is compatible to the RHE07 Batch Start and may be used to continue a suspended filling or restart the filling process after a successfully concluded filling.

It should be noted that DI functions 3 and 4 also undo this override effect but forcefully restart the totalizers and thus force a completely new filling. This is compatible to the RHE07 Batch Abort function.

The batch commands also may be issued via write to the Modbus Holding Register BatchCommand (0x6F22).

Since release 2.17 of the firmware it is also possible to configure a separate system reaction time to correct the high alarm levels of the DOs configured for batching purposes with the current flow. This is especially useful when the flow varies and a constant mass offset cannot be used to keep a target mass of volume in the desired range. When using the system reaction time in FillingReactionTime (0x6F36, initial value) or FillingReactionTimeCurr (0x6F38, current value) it is recommended to set the high alarm levels of the DOs, DigOutChXAlmHigh resp. DigOutChXAlmHighCurr, used for filling purposes close to the intended target and set the reaction time register to the system delay time in seconds.

The reaction time most likely is the closing time of the valves involved. This time in FillingReactionTimeCurr (0x6F38) multiplied with the current flow is subtracted from the high alarm level. The snapshot register BatchTotalSnapshot (0x4F0E) can be used to determine the effects of the current delay time and to optimize its setting.

The functionality of the registers mentioned in this chapter is described in the following table.

Address	Name	Description
0x6F22	BatchCommand	<p>Allows the execution of batch-related which usually are executed via the Digital Inputs. Any write to this field has an immediate effect. This function is disabled when bit 1 of register CustodyLockProperty (0x6F08) is 0 and the Custody/Hard Lock switch is active, i.e. Totalizer Resets are forbidden. This register is automatically reset to 0 when the command was executed.</p> <p>0: No operation / Idle.</p> <p>1: Batch Restart: This is the RHE07 compatible Batch Start command. It opens the valves by undoing the DO override caused by a Batch Hold command. It also conditionally resets the totalizers if the last filling has being concluded. See also functions 11 and 12 in the DIXProperty registers (0x6F0A and 0x6F0C).</p> <p>2: Batch Hold: This overrides the DOs to close the valves which are configured for batch mode (DigOutChXConfig is 7 or 8 and DigOutChXAlmType is 1 or 2) and their upper alarm limit is not yet reached. This is compatible to the RHE07 Batch Stop command. The totalizers are not affected. See also functions 9 and 10 in the DIXProperty registers (0x6F0A and 0x6F0C).</p> <p>3: Batch Reset: Resets the totalizers and terminates the DO overrides caused by command 2 and effectively forces a start of a new filling. See also functions 3 and 4 in the DIXProperty registers (0x6F0A and 0x6F0C).</p>
0x6F36	FillingReactionTime	<p>Reaction Time for Filling: Initial value for FillingReactionTimeCurr (0x6F38). This specifies the reaction time of the filling system, i.e. in most cases the closure time of a valve, in seconds. Only positive values are allowed. The default is 0.0.</p>
0x6F38	FillingReactionTimeCurr	<p>Current Reaction Time for Filling: Current value for the system reaction time. This specifies the reaction time of the filling system, i.e. in most cases the closure time of a valve, in seconds. Only positive values are allowed. Any change has an immediate effect.</p> <p>This value is used together with the current mass or volume flow to correct the timing of a digital output configured for batching (DigOutChXConfig is 7 or 8) by subtracting the mass or volume corresponding to the current flow from the upper limit (DigOutChXAlmHighCurr) configured in the DO setup parameters. Be aware that this correction is applied to all DOs configured for batching, for example both channels in a fine / coarse nozzle configuration.</p>

Address	Name	Description
0x4F0E	BatchTotalSnapshot	<p>Totalizer Snapshot at Batch End: Snapshot of the forward totalizer (TotalMassFwd, 0x4B00) when a Digital Output configured for batching (DigOutChXConfig is 7 or 8 and DigOutChXAlmType is 1 or 2) transitions its state. This will freeze the state of the current forward totalizer at the moment when a valve is closed and may be used to observe the difference to the forward totalizer when the filling is concluded in order to obtain the transferred mass after the valve close command. Note that this snapshot also may happen when the totalizer is cleared and the digital output transitions its state again. This value is based on the unit specified in MassUnit holding register (0x6104).</p>
0x4F10	BatchMassFlowSnapshot	<p>Mass Flow Snapshot at Batch End: Snapshot of the current mass flow (MassFlowRate, 0x4900) when a Digital Output configured for batching (DigOutChXConfig is 7 or 8 and DigOutChXAlmType is 1 or 2) transitions its state. This will freeze the current mass flow at the moment when a valve is closed and may be used to observe the difference to the forward totalizer when the filling is concluded in order to obtain the transferred mass after the valve close command. Note that this snapshot also may happen when the totalizer is cleared and the digital output transitions its state again. This value is based on the unit specified in MassFlowUnit holding register (0x6106).</p>

4.13 Drive Control

The power for the drive of the RHM sensors is controlled by a software loop which in turn is controlled by a parameter set found in the “Amplitude Diagnostic” parameter group. When an RHE transmitter is delivered together with an RHM sensor these parameters are already set appropriately by the factory. Any change should be done with care and under the guidance of the Rheonik service.

The control loop implemented in the software is a standard PID loop. Following parameters are defined:

Address	Name	Description
0x640A	OutputCtlTargetPickup	Specifies the target (peak) pickup voltage for the output drive control loop in mV units. The default is 80mV peak which corresponds to 160mV peak-peak. The range is from 40mV to 200mV.
0x640C	OutputCtlIntegralTarget	Specifies the range in which the integral portion of the control loop is engaged in percent. The default is 30% which together with a Target Pickup Voltage of 120mV means that the integral control portion is engaged in the range of 92.3 to 156mV.
0x640E	OutputCtlPropFactor	Defines the factor which influences the proportional portion of the control loop in the range of 0 to 20. The default is 8.
0x6410	OutputCtlIntFactor	Defines the integration time of the integral portion of the control loop in the range of 0 to 20. The default is 0.5 and the unit is 1/s.
0x6412	OutputCtlDiffFactor	Defines the factor which influences the differential portion of the control loop in the range of 0 to 20. The default is 0 which effectively disables the differential control.

The target pickup voltage OutputCtlTargetPickup is the most important parameter of this is set. It defines the desired voltage of the input pickup coils in mV units. When this parameter is set too high the drive output will always run on its maximum power at 100%.

The OutputCtlIntegralTarget parameter defines when the integral portion of the PID is engaged. Initially this portion usually is disabled in order to speed up the reaction time of the control loop. It is engaged when the pickup input voltage enters a band near the target pickup voltage defined by the percentage value in OutputCtlIntegralTarget.

The three parameters OutputCtlPropFactor, OutputCtlIntFactor, and OutputCtlDiffFactor define the magnitude of the proportional, the integral, and the differential portion of the PID control loop. When tuning these factors it has to be ascertained sure that the control loop does not oscillate.

The behavior of the control loop may be observed with the help of following Modbus input registers:

Address	Name	Description
0x4408	OutputCtlVal	Output value of the Drive Control Loop in the range of 0 to 4095.
0x440A	DriveCurrentRaw	Drive Current value in the range of 0 to 32767.
0x440C	DriveCurrentmA	Drive Current value in mA.
0x440E	DriveGain	Drive Gain in %. This corresponds to OutputCtlVal (0x4408).
0x4410	DriveStability	Indicates the stability of the drive control output in %. The changes of the drive control output are filtered (with Tau=8s), recalculated as percentage of the current output value and then subtracted from 100. Thus, a stability indicator of 100% means that the drive control output did not change for a while.
0x4412	AmplStability	Indicates the stability of the amplitude input in %. The target is the OutputCtlTargetPickup (0x640A) voltage. When the input amplitudes remain at this value the stability is 100%. Any deviation is filtered (with Tau=8s), converted in a percentage and subtracted from 100 to yield AmplStability.

The first three registers in this table are useful for diagnostic analysis by the service. The DriveGain value indicates the power output of the drive in percent and thus is more useful to obtain an overview of the state of the drive. This is also true for the DriveStability and AmplStability registers which indicated the stability of the drive and the pickup amplitudes in percent units.

When there is a constant flow through an RHM sensor with a substance which has a constant density the drive gain and the pickup amplitude should stable and the respective stability indicators should have values of close to 100%. Lesser indicators can be caused by coarse changes in the mass flow or the density of the substance. Vibrations or cavitation at the RHM sensor may degrade the stability considerably.

The stability indicators are also displayed in the Assurance View screens of the HMI together with other useful status information.

4.14 Hardware Lock Switch / Custody Transfer Lock

Some models of the RHE20 transmitter series feature a Hardware / Custody Transfer Lock switch. When this switch is activated no parameters may be changed neither via the HMI nor via Modbus or HART communication. Test output settings are prohibited, as well.

Depending on the setting of the parameter CustodyLockProperty (0x6F08) a zeroing of the RHM sensor is prohibited (0 or 2) or allowed (1 or 3). A command modifying the state, e.g. reset, of the totalizers may be prohibited (0 or 1) or is allowed (2 or 3). The default of 2 allows a state change of the totalizers but prohibits the zeroing of the RHM sensor. This affects the totalizer reset or the zeroing initiated via the digital inputs or via Modbus register accesses. The following table details the meaning of the values in the CustodyLockProperty register:

Value	Meaning
0	Neither totalizer reset nor zeroing allowed when the Hardware Lock Switch is active.
1	Totalizer reset is prohibited but zeroing is allowed when the Hardware Lock Switch is active.
2	Zeroing is prohibited but totalizer reset is allowed when the Hardware Lock Switch is active.
3	Both totalizer reset and zeroing are allowed when the Hardware Lock Switch is active.

Note that a totalizer reset does not affect the pulse output which usually is the basis for the mass or volume transferred.

Other functions which may affect the state of the system are disabled, as well, when the custody transfer lock switch is active. This concerns mainly the firmware or the CLPD update. The activation of the bootloader and its functionality is prohibited in general.

When the Custody Transfer Lock switch is active the orange LED at the front is lit and Bit 22 in the InfoStatus Modbus register (0x4020) is set. Furthermore certain HMI status screens which also display information about the firmware version indicate the “locked” status of the transmitter. Thus the state of the Custody Transfer Lock is perceivable by a human user and may be verified by an automated system.

4.15 Special Density Calculations

The RHE20 transmitters may be ordered with an option named “API Density / Net Oil” which offers a number a calculations which affect the density within the system and thus also affect the volume flow calculated from the mass flow. When the transmitter is ordered with this option the Modbus holding register APIDnsPresent (0x6092) is non-zero. In order to activate the Special Density Calculation feature the density must be measured by the RHM sensor, i.e. DnsConfig (0x6800) must be 1 and VolDensPresent (0x6084) must be non-zero.

When all these conditions are met the setup parameter DenCalcMode (0x683A) may be set to one of the values shown in the table below:

DenCalcMode	Special Density Calculation Feature
0	No special density calculation is done (default). In this case the register StdDensity (0x480A) will contain the same value as DenComp and VolPercentMainSubstance (0x480C) always will be 100%.
1	API MPMS Density calculation for Crude Oil. The volume flow and total is based on the calculated standard density.
2	API MPMS Density calculation for Refined Products. The volume flow and total is based on the calculated standard density.
3	API MPMS Density calculation for Lubricants. The volume flow and total is based on the calculated standard density.
4	“Net Oil” Calculation based on the Crude Oil density found in DenMainSubstance, the Water Density found in DenAddSubstance, and the implied salinity of the water. The result is found in VolPercentMainSubstance (0x480C) and the volume flow and total is calculated based on the portion of the main substance.
5	Percent substance calculation based on the density of the main substance found in DenMainSubstance and the density of an additional Substance found in DenAddSubstance. The result is found in VolPercentMainSubstance (0x480C). The volume flow and total is calculated based on the portion of the main substance.
7	Percent substance calculation based on the density of the main substance found in DenMainSubstance and the density of an additional Substance found in DenAddSubstance. The result is found in VolPercentMainSubstance (0x480C). The volume flow and total is calculated based on DenComp, the measured density and not the portion of the main substance.

Note: When the API Density calculation is active (DenCalcMode is 1, 2, or 3) the HMI displays the API standard density and the volume flow and volume totalizer is calculated on the basis of the API

density. For the modes 4 and 5 the HMI displays the measured density, the volume flow, however is calculated on basis of the predefined density and calculated volume portion of the main substance.

Also note, that the effects of the special density calculation modes on the calculated volume flow, volume totals, and the standard density is also reflected by the frequency, pulse, and current outputs when these indicators are based on volume data or the density.

The details of the different calculation modes are described in the next subchapters.

4.15.1 API MPMS Density Calculation (Modes 1 to 3)

The modes 1 to 3 in DenCalcMode (0x683A) select the calculation of the standard density at 60°F and the standard atmospheric pressure for different hydrocarbon types in accordance with the API MPMS Standard (Chapter 11, Section1, Addendum 1, September 2007). The transmitter corrects the measured density found in the DenComp (0x4806) register and corrects it with the help of the tube temperature (AdcTubeMeanTemp, 0x4500) and the current pressure (PrsMean, 0x4606) into the standard density as defined by the API MPMS Standard. The resulting standard density is found in the register StdDensity (0x480A).

This density value is the basis for the calculation of the volume flow and the volume total and is displayed in the HMI or by the main dashboard of the RHEComPro instead of the measured density. The measured density in DenComp still is available in the “Measurement” menu tree of the HMI and in the “Data Selection” Window of the RHEComPro program.

Usually the measured density and the standard density values are different and thus the indicated volume total in the totalizers will be different from the real volume of the fluid.

The origin of the pressure and temperature values for the API MPMS density calculation are determined by the setup parameter PressureCalcConfig (0x6610). The temperature may be taken from the tube temperature measurement, AdcTubeMeanTemp (0x4500), from an external temperature sensor or from a periodically updateable Modbus register, ExtTemperatureCurr (0x662A).

The pressure data may be fixed (see register PrsExternalInitial, 0x6612), periodically updated by Modbus writes (see register PrsExternalCurrent, 0x6620), or a result of a measurement of an external pressure sensor attached to the analog input of the RHE transmitter as described in section 4.7. The API MPMS Density Calculated assumes an absolute pressure value from which is subtracts the standard pressure (gauge) as required by the standard. The pressure compensation is disabled when a fixed pressure of 1013.25 hPa (14.696 Psi[a]) is configured.

The API MPMS Density calculation is defined for a standard density range depending of the type of the hydrocarbon, a temperature range of -58.0 °F to 302.0 °F, and a pressure range from 0 to 1500 Psi[a]. When one of the ranges is exceeded bit 27 in the Warnings (0x401E) register is set to indicate an invalid density calculation.

In the API MPMS Density calculation modes the values in the registers VolPercentMainSubstance (0x480C) and CutMainMass (0x480E) are fixed to 100.0% and 1.0 respectively.

4.15.2 Net Oil Calculation (Mode 4)

Crude Oil is often mixed with water. When the density of both substances are different enough (>10%) it is possible to calculate the amount of oil in the mixture out of the measured density. In order to set up this calculation mode the standard density (at 60°F and standard pressure) of the

crude oil portion must be entered into the register DenMainSubstance (0x683C) and the standard density of the water must be entered into DenAddSubstance (0x683E). The density of the crude oil must be in the range of 610.6 to 1163.5 kg/m³ and the density of the water is restricted to the range of 997.0 to 1300.0 kg/m³. Bit 13 in the ErrorStatus register is set when these ranges are exceeded.

Both standard densities are used to calculate density values which correspond to the current environmental conditions indicated by AdcTubeMeanTemp (0x4500) and PrsMean (0x4606) before the portion of the crude oil in the current substance mix is calculated. The calculation for the density of the crude oil follows the API MPMS Standard and the calculation for the water density use the formulas found in Deep-sea Research, vol. 28A, no. 6, pp. 625-629. The water density calculation takes the temperature, the pressure, and the salinity contents into account.

The resulting volume portion of the crude oil is found in VolPercentMainSubstance (0x480C) in percent units and the resulting mass portion of the crude oil is found in CutMainMass (0x480E) as number in the range of 0.0 to 1.0 (corresponds to 0 to 100%). The register StdDensity (0x480A) is set to the predefined standard density of the crude oil. The register DenComp contains the measured density of the substance mix.

Based on these data items the standard volume of the crude oil in the substance mix is calculated and displayed as volume flow or volume total (e.g. VolumetricFlowRate, 0x4A00). The mass flow and mass total values refer to the measured mass of the substance mix.

Since the API MPMS Standard has certain limits (see section 4.15.1) bit 27 in the Warnings (0x401E) register is set to indicate an invalid density calculation when these ranges are exceeded.

When the density values of the substances are rather close the measurement error of the density increases disproportionately in regard of the substance portions. Thus, the use of this calculation mode must be tested in practice in order to evaluate the results against the required performance.

4.15.3 Percent Substance Calculation (Mode 5)

The mode 5 of the special density calculations is very similar to mode 4. It works for arbitrary pairs of substances and since the densities of unknown substances cannot be compensated for changes in environmental conditions their densities must be given for the current temperature and pressure in the fields DenMainSubstance (0x683C) and DenAddSubstance (0x683E).

These two densities must differ at least 10% from each other, otherwise bit 13 in the ErrorStatus register is set. Together with the measured density in DenComp (0x4806) they are used to calculate the portion of the main substance in the mix of the two substances. The resulting volume portion of the main substance is found in VolPercentMainSubstance (0x480C) in percent units and the resulting mass portion is found in CutMainMass (0x480E) as number in the range of 0.0 to 1.0 (corresponds to 0 to 100%). The register StdDensity (0x480A) is set to the density of the main substance.

Based on these data items the standard volume of the main substance in the substance is calculated and displayed as volume flow or volume total (e.g. VolumetricFlowRate, 0x4A00). The mass flow and mass total values refer to the measured mass of the substance mix.

The statement concerning similar density values given in section 4.15.3 applies to mode 5, as well.

4.15.4 Percent Substance Calculation (Mode 7)

This works very much as described in the previous section, but the volume and the volume flow is calculated on the basis of the measured density, i.e. the density of the substance mix and thus will reflect the real volume and volume flow transferred.

4.16 Partly Filled Pipe Management

A partly filled pipe may be detected by the RHE transmitter using two different methods. One method involves the supervision of the density limits and the other methods uses the pickup voltage level as indicator of a possible multi-phase flow.

The method using the density limits is available only when the transmitters was ordered with the Standard Density Calculation option. The method using the pickup voltage level is available only when the transmitter was ordered with the Assurance Factor Calculation option. It is recommended to combine both methods to handle partly filled pipe conditions properly.

Following Modbus register are used to set up the partly filled pipe supervision feature:

Address	Name	Description
0x6804	DenUpFctSL	Density Upper Functional Safety Limit: The upmost limit for compensated density in the range of 0 to 12000kg/m ³ . When this limit is exceeded a warning is indicated –bit 7 in the SoftError (0x401C) input register is set. The default value is set to 12000kg/m ³ . This value is based on the unit specified in the DensityUnit holding register (0x6108).
0x6806	DenLwFctSL	Density Lower Functional Safety Limit: The lower limit for compensated density in the range of 0 to 12000kg/m ³ . When this limit is exceeded a warning is indicated –bit 7 in the SoftError (0x401C) input register is set. The default value is set to 0kg/m ³ . This value is based on the unit specified in the DensityUnit holding register (0x6108).
0x6854	DnsMassFlowSupervision	Density Supervision of the Mass Flow: When set to 1 and AssurancePresent (0x6090) is not 0 an exceedance of the limits defined in DenUpFctSL (0x6804) and DenLwFctSL will result in a stop of the calculated mass flow after the time span specified in MassFlowHoldTime (0x6420) has passed. The default 0 disables this feature.
0x641E	PickupMinLevel	Minimum Pickup Level: Minimum pickup voltage level in percent of the target pickup level (OutputCtlTargetPickup, 0x640A) below the mass flow measurement is stopped because a multi-phase mode flow is assumed which greatly reduces the accuracy of the measurement. A value of 0.0 (default) disables this feature as does a value of 0 in APIDnsPresent (0x6092). When this feature is enabled and the pickup level drops below the specified level bit 25 in the SoftError Register is set. After this event the mass flow and the calculated density measurements are kept at the current level for the time span specified in MassFlowHoldTime (0x6420) before the mass flow set to 0.
0x6420	MassFlowHoldTime	Mass Flow Hold-Up Time: Time span in seconds after the beginning of one of the conditions described for PickupMinLevel (0x641E) or DnsMassFlowSupervision (0x6854) becomes true during which the mass flow and the density calculation is kept at the same level before the mass flow is set to 0. The default is 0s. The maximum is 60s.

In order to modify these registers the Service role must be used. Following relevant flags in the SoftError (0x401C) status register are affected by these methods:

Bit	Description
7	Density limit exceeded.
25	Pickup voltage below defined threshold detected. Multi-phase flow assumed.

In order to setup the density supervision method the lower and upper density limits of the measured substance must be written into DenLwFctSL (0x6806) and DenUpFctSL (0x6804) respectively, followed by the value 1 into DnsMassFlowSupervision (0x6854). Should the last correctly measured mass flow and density value be used for mass flow, volume flow, mass total, and volume total calculations for a time span after the detection of an out-of-range density this time span must be written into MassFlowHoldTime (0x6420). Otherwise this register should have the value 0.

Assuming a proper setup of these registers the mass and volume flow is kept constant for the time span specified in MassFlowHoldTime after the transmitter detected an out-of-range condition for the density. Should this condition persist after this time span expired the mass and volume flow is set to zero and no further mass or volume increments are added to the totals. There may be a minor amount of mass and volume increments in transmitter-internal filters which still will increase the totals, but these origin from before the shutdown of the mass and volume flow.

This special condition is signaled in the setting of bit in 7 in the SoftError register and also causes the red LED to be lit. When the error condition disappears the error indicators are reset and the mass and volume flow calculations are resumed as normal by the RHE transmitter.

Since a fluid/gas mixture may dampen the oscillation of the RHM tubes up to a point and beyond where the target pickup voltage cannot be maintained by the drive control loop a drop of the pickup voltage level may be used as indicator of an impure flow.

The corresponding supervision method may be set up by writing a value different from 0 into the register PickupMinLevel (0x641E). This specifies the percentage of the target voltage that a pickup voltage must surpass in order to maintain a normal measurement mode. Should the pickup voltage drop below this level the current mass flow and density is maintained for the time span specified in MassFlowHoldTime (0x6420). When this condition persists after the specified time has passed the mass and volume flows are stopped as described above. The error condition bit also causes the red LED to be lit. When the error condition disappears the error indicators are reset and the mass and volume flow calculations are resumed as normal by the RHE transmitter.

Note that depending on the RHE and RHM type severe gas contents in a fluid may also stop the RHM sensor oscillation entirely. In this case other error conditions, namely bit 6 in ErrorStatus and bit 22 in SoftError, are raised which also cause to stop the mass flow and thus the volume flow measurements. A value 0 in PhsControl (0x6310) allows the transmitter to recover from this condition even when it lasts a prolonged time. Otherwise, a severe equipment or installation malfunction is assumed and the error condition is latched up to the next system reset.

Following values could be used to test these features for a fuel-type substance:

Name	Value
DenUpFctSL	900 kg/m ³
DenLwFctSL	700 kg/m ³
DnsMassFlowSupervision	1
PickupMinLevel	80 %
MassFlowHoldTime	20s

For a water-type substance the density limits could be set to 1100 kg/m³ (DenUpFctSL) and 900 kg/m³ (DenLwFctSL).

Note, that the density supervision method does not depend on the method by which the density is calculated, i.e. not on the setting of DnsConfig (0x6800). Thus, using a value of 2 in DnsConfig allows the evaluation of this feature by writing simulated density values into VolFlwNorDensCurr (0x6838). This has an immediate effect and does not require a transmitter reset.

It is expected that the RHM-based density calculation method is used in a standard operation setup (1 in DnsConfig), but also an external density sensor attached to the 4-20mA input (4 in DnsConfig) makes sense.

5 HART® Protocol Interface

The RHE20 transmitters feature up to two 4-20mA current outputs. The first current out labelled “1” may be equipped with a HART® Modem when the RHE transmitter is ordered with the respective option.

The functionality provided by the RHE20 HART® protocol is described in a separate document “RHE20/40 HART Reference”, see also section 1.3.

The low-level protocol parameters such as the polling ID, the loop state, and the number of preambles to send are part of the “Generic” parameter set where also the Modbus parameters are found.

Following Parameters are defined.

Address	Name	Description
0x60A0	HARTPollingID	HART Polling ID in the Range of 0 to 15. Note, that a polling id different from 0 does not automatically imply a disabled current loop (HART V7). Use HARTLoopState (0x60A2) to disable the current loop. Default is 0.
0x60A2	HARTLoopState	When set to 0 HARTLoopState disables the current loop and fixes it to 4mA. When set to 1 the loop is enabled and reflects the value of the assigned parameters.
0x60A4	HARTPreambles	HART Preamble characters to be used when a response telegram is transmitted in the Range of 5 to 15. Default is 5.

Note that the HART® protocol implementation follows the protocol definition in the Version 7 which does not automatically disable the current loop when the polling ID is set to a value different than 0. This is only done when the HART® master identifies itself with the Version 5.

These parameters and other current loop related parameters may also be set via the HART® interface and the commands by the standard.

6 Troubleshooting

The RHE transmitter offers a number of different indications and diagnostics about the status of the RHE/RHM measurement system. The LEDs on the front face of the RHE transmitter are intended to give a quick visual indication of the current state of the device. More detailed and specific information can be obtained from the MODBUS status registers.

6.1 Failure Causes and Consequences

There are several causes of failures within and at the interfaces of the RHE transmitter which are considered fatal in the sense that the measurement results are considered compromised.

Failure Class	Causes and Consequences
1. Configuration Errors	<p>Implausible configuration of density, Standard Density, pressure, 4-20mA interfaces or Batching feature most likely of the type “upper range lower than lower range”.</p> <p>At least one of the bits 1, 2 or 3 to 13 in the ErrorStatus (0x401A) register are set. Also bit 24 in SoftError (0x401C) could be set.</p> <p>In this case the RHE transmitter tries to operate as normal as possible and return plausible measurement data. When the density configuration is affected no volume flow is indicated.</p>
2. Loss of NVM/EEPROM Data detected at system startup	<p>A loss of NVM/EEPROM data should never happen because all this data is kept in at least two redundant data sets. In spite of this the firmware is able to handle this unlikely event as follows:</p> <p>Loss of the Totalizer Data: Bit 6 in the ErrorStatus (0x401A) register is set. The Totalizers are reset to 0 and the RHE transmitter tries to operate as normal as possible and return plausible measurement data.</p> <p>Loss of the Zeroing Data: Bit 4 in the ErrorStatus (0x401A) register is set. The Zero Point is reset to 0 and the RHE transmitter tries to operate as normal as possible and return plausible measurement data. A higher than normal measurement error has to be expected.</p> <p>Loss of the Setup Data: Bits 0, 7 or 8 in the ErrorStatus (0x401A) register are set.</p> <p>All setup data including the calibration information is reset to default values. The RHE transmitter tries to operate as normal as possible, but the results must not be trusted.</p>
3. RHM Sensor failure	<p>The RHM sensor pickup coils do not deliver a plausible signal most likely due to a wire break or a loose connection at the terminals.</p> <p>Bit 6 in the ErrorStatus (0x401A) or bits 12 to 14 or bit 22 in the SoftError (0x401C) register are set.</p> <p>The RHE transmitter will cease to report mass and volume flows and freezes the totalizers as long as this condition lasts. Depending on bit 0 in the PhsControl (0x6310) register the failure bit 6 in ErrorStatus (0x401A) is kept set when this conditions lasts for more than 100 seconds even when the RHM sensor starts to work properly again. This signals that the totalizers cannot be trusted due to a temporary sensor failure. As a consequence the RHM sensor must start to oscillate properly within 100s after system startup.</p>

Failure Class	Causes and Consequences
4. Temperature Data Failure	The RHM temperature sensors do not deliver a plausible signal most likely due to a wire break or a loose connection at the terminals. Bit 2 in the ErrorStatus (0x401A) register or bits 3 or 4 in the SoftError (0x401C) register are set. The RHE transmitter tries to operate as normal as possible and return plausible measurement data. A higher than normal measurement error has to be expected.
5. Failure of Pressure data when configured for the 4-20mA input	Break of wires, loose terminals at the 4-20mA input, or fire state signaled by the pressure sensor causes to bit 11 in SoftError (0x401C) to be set.
6. Measurement Range Exceedance	Exceedance of hard limits of the mass flow, volume flow, and density measurements which will cause one of bits 7, 8, 9, 15, or 16 in SoftError (0x401C) to be set. The RHE transmitter tries to operate as normal as possible and return plausible measurement data.
7. Fraud Detection (Special Function)	A fraud attempt was detected which causes bit 23 in SoftError (0x401C) to be set. The RHE transmitter tries to operate as normal as possible and return plausible measurement data.

These failure indications may be read out via the Modbus communication. Additionally, failures can be perceived on multiple failure indicators as indicated in the table below.

Failure Indicator	Indicated Failures
Red Led, see also section 0.	All failure classes – any bit set in the ErrorStatus (0x401A) or SoftError (0x401C) registers.
DO4 (Channel 0) resp. DOA (Channel A routed to DO1) when configured for error indication (DigOutChXConfig is 0).	All failure classes – any bit set in the ErrorStatus (0x401A) or SoftError (0x401C) registers.
Fire State on 4-20mA interfaces when configured for error indication (CurOutFireState [0x6C28] resp. CurOut2FireState [0x6C28] set in the range of 6 to 10).	All failure classes – any bit set in the ErrorStatus (0x401A) or SoftError (0x401C) registers.
Display background illumination is red when configured for Namur color indications (HMIBackgroundLEDs [0x6F1C] is 0).	Failure classes 2 to 5 – all hardware related failures.
Display background illumination is blue when configured for Namur color indications (HMIBackgroundLEDs [0x6F1C] is 0).	Failure classes 1 – all configuration errors.
Display background illumination is yellow when configured for Namur color indications (HMIBackgroundLEDs [0x6F1C] is 0).	Failure classes 6 – all range exceedances failures.
Stop of the pulse output of the second pulse output channel when the pulse output is configured to dual mode (VersDigOutCh0Config [0x 6D06] is set to 3 or 4).	All failure classes – any bit set in the ErrorStatus (0x401A) or SoftError (0x401C) registers.
Global error indications „Device Malfunction“ / „More Status Available“ are set in the status fields of the HART communication frames.	All failure classes – any bit set in the ErrorStatus (0x401A) or SoftError (0x401C) registers.

A complete failure of the firmware due to a program flash failure will be indicated by the green LED being off.

6.2 LED Status Indicator Description

There are three LED's on the front face of the RHE transmitter. The following table gives an overview about the possible states of these LEDs and their meanings.

LED	State	Meaning
green	Off	RHE transmitter is not reading. The device is either initializing after a system reset, has no power, or is defective.
	On	RHE transmitter operative. MODBUS communications is possible.
	Blinking	A fast blinking green LED indicates that the bootloader of the RHE transmitter is active, usually seen during download/upgrade of instrument firmware.
Red	Off	No errors are present and the instrument is operating as intended.
	On	There is at least one error being reported by the instrument. Details of the exact error(s) can be obtained by reading the error status registers SoftError and ErrorStatus via MODBUS.
	Blinking	When the orange and the red LEDs blink together, the Zeroing Process is in progress.
Orange	On	Custody Transfer Lock active.
	Off	Custody Transfer Lock inactive.
	Blinking	When the orange and the red LEDs blink together the Zeroing Process is in progress.

Note that the red LED is usually illuminated during transmitter initialization and for a short while thereafter while the RHM flow sensor stabilizes. A few seconds after transmitter reset or power-on, the red LED should go out; the exact timing depends upon the model of the RHM flow sensor. No meaningful measurement is available while the red LED is lit.

6.3 MODBUS Status Register Description

The RHE transmitter has four MODBUS status registers that provide detailed information about the measurement status of the device. Bits in these registers are set true whenever a condition occurs that is outside of the normal operating envelope of the flow meter and/or user configured settings. The dashboards in the RHEComPro software program display the four status registers and provides a human readable interpretation of them for convenience. Information regarding any status register is displayed when the button labeled "Details" next to the status register is clicked.

The four status registers are as follows (see also Appendix D.8):

Address	Name	Usage
0x401A	ErrorStatus	This register contains information of persistent errors. Once a bit is set in this register, it remains set until the next system reset or power cycle. Error conditions that cause bits to be set in this register may be the failure of an internal self-test or a bad configuration error. Configuration errors are remedied by correcting the setup. See Table 1 for a listing of ErrorStatus register bit definitions.

Address	Name	Usage
0x401C	SoftError	The SoftError register contains information related to transient error causes and will reset automatically when the error is no longer present. Typical examples include exceeding factory-set hard limits or unstable sensor operation. See Table 2 for a listing of SoftError register bit definitions.
0x401E	Warnings	Warnings are conditions which do not result in incorrect measurements. A typical warnings is exceeding a user-defined warning level. Warning status bits reset automatically when the condition that created the warning is no longer present. See Table 3 for a listing of Warning register bit definitions.
0x4020	InfoStatus	The InfoStatus register contains information about the system state and is mainly used for service purposes. The InfoStatus register also contains flow direction indication. See Table 4 for a listing of InfoStatus register bit definitions.

6.3.1 ErrorStatus Register

Bit	Description
0	Internal EEPROM error. Inconsistencies in the parameter memory were detected after instrument power up and parameters were reset to default. Reinstallation of the system parameters is necessary. Contact Rheonik for assistance.
1	4...20mA current output 1 configuration is invalid. Correct setup and reset the transmitter.
2	Pulse output configuration is invalid. Correct setup and reset the transmitter.
3	Temperature measurement time out (no response). Reset the system and contact Rheonik if the error persists.
4	Zeroing data lost. Perform a zero on the meter.
5	Internal totalizer data lost. Reset the totalizer.
6	No response from the sensor interface. Check interconnection to the RHM flow sensor and reset the RHE transmitter.
7	EEPROM data lost. Perform a power cycle and check all setup data, especially calibration information, if the error is resolved. Contact Rheonik for assistance if the error persists.
8	Non-volatile memory error. Perform a power cycle and check all setup data, especially calibration information, if the error is resolved. Contact Rheonik for assistance if the error persists.
9	Density configuration error. Correct setup and reset the transmitter.
10	4...20mA current output 2 configuration is invalid. Correct setup and reset the transmitter.
11	Configuration of the 4-20mA Input (Pressure/Density) invalid. Correct setup and reset the transmitter.
12	Automatic Batch Configuration invalid. Correct setup and reset the transmitter.
13	Special Density Calculation configuration invalid.

Table 1: Bit definitions in ErrorStatus register

6.3.2 SoftError Register

Bit	Description
1	Current Output Read back Failed (hardware failure at the 4-20mA analog output).
2	Pulse Output Range Exceeded (possible configuration error).
3	Tube Temperature Reading Error (possible hardware/wiring error).
4	Torsion Bar Temperature Reading Error (possible hardware/wiring error).
5	Transmitter Electronics Temperature Reading Error (possible hardware error).
6	ADS1248 failure. Internal hardware error related to the temperature measurement.
7	Density limit exceeded (possible configuration error).
8	Mass Flow limit exceeded (possible configuration error).
9	Volume Flow limit exceeded (possible configuration error).
10	Zeroing Process not successful (possible sensor instability, retry/restart the zeroing process).
11	Bit 11: Analog (Pressure/Density) Input Exceedance (Firestate)
12	Sensor signals outside of expected ranges (may occur during startup, possible hardware error when persistent, check interconnection to RHM flow sensor)
13	Out of range sensor frequency detected by CPLD (may occur during startup, possible hardware error when persistent, check connections to RHM flow sensor)
14	Out of range sensor phase detected by CPLD (may occur during startup, possible hardware error when persistent, check connections to RHM flow sensor).
15	Density range exceeded (possible configuration error).
16	Volume range exceeded (possible configuration error).
17	Sensor amplitude out of range (may occur during startup, possible hardware error when persistent, check connections to RHM flow sensor)
18	RHE transmitter firmware performance problem (possible hardware error).
19	RHE transmitter firmware/hardware self-test failure.
20	CRC error in flash memory used for Zeroing data (repeat the zeroing process. Contact Rheonik if the problem persists).
21	CRC error found in flash memory used for Totalizer data (reset the totalizers. Contact Rheonik if the problem persists).
22	Sensor not (yet) ready (may occur during startup, probable hardware error when persistent, check connections to RHM flow sensor).
23	Special Function 1: Fraud Attempt Detected.
24	Inconsistent calibration information for the 4-20mA analog input interface provided. Recalibrate and reset the transmitter.
25	Pickup voltage below defined threshold detected. Multi-phase flow assumed. See section 4.16.

Table 2: Bit definitions in SoftError register

6.3.3 Warnings Register

Bit	Description
0	Density upper warning limit exceeded. Check user set upper warning limits for density measurement.
1	Mass flow rate upper warning limit exceeded. Check user set upper warning limit for mass flow rate measurement.

Bit	Description
2	Volumetric flow rate upper warning limit exceeded. Check user set upper warning limit for volumetric flow rate measurement. Problem may also be density-related.
3	Tube temperature upper warning limit exceeded. Check user set upper warning limit for tube temperature measurement.
4	Torsion bar temperature upper warning limit exceeded. Check user set upper warning limit for tube temperature measurement.
8	Total forward mass warning limit exceeded. Check user set warning limit for mass totalizer.
9	Total forward volume warning limit exceeded. Check user set warning limit for volume totalizer.
11	Pressure Warning Range exceeded.
15	Current Output 1 Range Exceeded (probable configuration error).
16	Density lower warning limit exceeded. Check user set lower warning limit for density measurement.
17	Mass flow rate lower warning limit exceeded. Check user set lower warning limit for mass flow rate measurement.
18	Volumetric flow rate lower warning limit exceeded. Check user set lower warning limit for volumetric flow rate measurement.
19	Tube temperature lower warning limit exceeded. Check user set lower warning limit for tube temperature measurement.
20	Torsion bar temperature lower warning limit exceeded. Check user set lower warning limit for torsion bar temperature measurement.
21	Current Output 2 Range Exceeded (probable configuration error).
24	Mass totalizer exceeds lower user warning limit.
25	Volume totalizer exceeds lower user warning limit.
27	Special density calculation out of defined limits.
29	Software performance problem detected.
30	Density change exceeds set limit.
31	Mass flow change exceeds set limit.

Table 3: Warning status bit definitions in Warnings

6.3.4 InfoStatus Register

Bit	Description
0	User is logged in via RS485 (User Level active).
1	Service is logged in via RS485 (Service Level active).
3	Factory is logged in via RS485 (Factory Level active).
4	User is logged in via USB (User Level active).
5	Service is logged in via USB (Service Level active).
6	User is logged in via USB (User Level active).
7	Zeroing button pressed, zeroing process is active.
11	Current Output 1 not powered properly.
12	Current Output 2 not powered properly.
15	Mass flow is zero, below cutoff limit.
16	Flow direction: 0-REVERSE, 1-FORWARD.
22	Custody Transfer Lock Switch active.

Bit	Description
23	Cause of last system reset is unknown.
24	Last system reset was triggered by command (via Modbus).
25	Last system reset was caused by a system/software failure.
26	Last system reset was caused by a power cycle.
27	Last system reset was caused by over- or under-voltage on the CPU.
28	Last system reset was caused by a power failure.
29	Default data/parameter for Totalizer and zeroing used. Totalizer contents lost.
30	On board counter detected (normal).
31	On board Non Volatile Memory detected (normal).

Table 4: Status bit definitions in InfoStatus

6.4 Problem Solving

The following subsections are intended as an aid to solving operational problems with the RHE transmitter. Please refer to the Operating Manual of the respective RHE type for the identification of the external signals and terminals described below.

6.4.1 Pulse/Frequency or Digital Outputs Not Working

The following checks are suggested when the pulse output is not working:

1. Use the “Info” / “About” functionality described in the RHEComPro Suite User Manual in order to determine whether the RHE transmitter is equipped with the Digital Output option. If the transmitter was purchased without the digital output option, signals will not be available at the terminals assigned to the digital outputs.
2. Check whether the MODBUS status register ErrorStatus (0x401A) for a pulse output configuration error (bit 2). If bit 2 is set, check and correct the pulse output configuration.
3. Check that the pulse output is configured properly. It may be disabled in configuration settings.
4. Check for reverse flow direction. If the pulse output is configured for forward flow and the flow rate shows a negative value, no pulses will be present unless the 90 degrees phase shift configuration (values 3 or 4 in VersDigOutCh0Config (0x6D06)) is chosen. Either reconfigure the output to the correct flow direction or invert direction using the PhsFlwDirConfig (0x6308) configuration register.
5. Check the wiring and ensure a proper pull-up resistor for the external power supply.
6. Connect an oscilloscope between the common ground and the faulty output terminal. Use the MODBUS test registers defined for the output (see sections 4.8.3 and 4.8.4) to stimulate the output and check the oscilloscope for changing state. If the output remains high or low when commanded to a different state, the digital output is damaged, possibly due to a short circuit overload.

6.4.2 Current Output Not Working

The following checks are suggested when the current output is not working:

1. Use the “Info” / “About” functionality described the RHEComPro Suite User Manual in order to determine whether the RHE transmitter is equipped with the Current Output option. If the transmitter was purchased without the current output option, a signal will not available at the terminals assigned to the current output.

-
2. Check the MODBUS CurOutConfig (0x6C06) register for the Current Output 1 resp. the CurOut2Config (0x6C46) register for the Current Output 2. If this is set to 0, the respective current output is disabled.
 3. Check whether the MODBUS status register ErrorStatus (0x401A) is indicating a current output configuration error (Bit 1 or Bit 10). If Bit 1 or Bit 10 is set, correct the respective current output configuration. A common problem is that the upper range value is equal to or lower than the lower range value.
 4. Check whether the MODBUS status register Warnings (0x4020) indicates the proper powering of the respective current output in its bits 11 or 12. Since the current outputs are implemented as passive and galvanically isolated they must be powered externally or via the 24V source available at the terminals of the RHE transmitter.
 5. Check whether the MODBUS status register SoftError (0x401C) is indicating a current output range error (Bit 0). If Bit 0 is set, the current output is driven to the error/fire state condition set in the CurOutFireState (0x6C28) register. This setting may drive the current output to a value outside of the usual 4-20mA range.
 6. Disconnect the wiring from terminals of the respective current output at the RHE transmitter, connect the 24V terminal to the positive pole (AN1H or AN2H) of the current loop and connect a 250 Ohm (e.g. 1% tolerance) resistor from the negative pole of the current loop (AN1L resp. AN2L) to GND. Connect a voltmeter in parallel across the resistor. Set the current output to a 10mA output by writing the value 1 to CurrOutTestStart (0x6C02) and the value 10.0 to CurrOutTestValue (0x6C04) registers for the Current Output 1 or the value 1 to CurrOut2TestStart (0x6C42) and the value 10.0 to CurrOut2TestValue (0x6C44) registers for the Current Output 2. A voltage of approximately 2.5V should be displayed on the voltmeter. If this is the case, the problem is related to external wiring/equipment. If the voltmeter reading is at or close to 0V, the current output may be defective and must be repaired. If any other constant value is displayed on the voltmeter, check the current output calibration register entries. If necessary, reset these values to their default values and check the output again.

6.4.3 Red Error LED is ON

There are many conditions that can cause the red error LED to be lit. All of these conditions are found in either the ErrorStatus (0x401C) register or the SoftError (0x401E) register. Use the dashboards in the RHEComPro program to review the contents of these registers. Click on the "Details" button beside any register whose contents are displayed on a red background.

Clicking on the details button will bring up a pop up window listing which bits are set along with a short explanation of the error. A more detailed description of the error and probable causes are found in sections 6.3.1 and 6.3.2.

For some special cases, the next few subsections will further help to identify and correct the cause of the problem.

6.4.3.1 SoftError, Bit 4: Torsion Bar Temperature Reading Error

When connected to a RHM flow sensor with only one temperature sensor (9 terminals, Pt100), the RHE transmitter default temperature sensor configuration must be modified as described in type-specific installation manual.

If the RHM flow sensor has two temperature sensors (11 terminals used mainly for Pt1000 or 12 terminals used for older Pt100 versions in the cable connection box), the problem requires further investigation. Check the wire connections on terminal at the RHE transmitter and the RHM which

are used by the temperature sensors. If all connections are the correct color, are tightened properly and are making proper contact, disconnect the cable at the RHM and measure the resistance between terminals. For a 11-terminal connection block measure the resistance between terminals between terminals 4 and 5. Pt1000 sensors should indicate values around 1000 Ohms whilst Pt100 indicate values around 100 Ohms with a valid range from 80 to 300 Ohms.

In the case of a 12 terminal box measure the resistance between terminals 11 and 12 and 11 and 5. In both cases, a value between 80 and 300 Ohms (depending upon the actual temperature of the sensor) should be read. If these readings are open/short circuit or indicating some other, out of range value, the temperature sensor in the RHM flow sensor is defective.

If these readings are in specification, re-connect the wires to terminals at the RHM and disconnect the respective wires at the terminals on the RHE transmitter. Repeat the resistance measurement described above at the ends of the wires

Measure the resistance between the cables that are connected to RHM terminals 11 and 12 and 11 and 5. Almost identical results to the measurements made at the RHM terminals is expected. If this is not the case, it would suggest that there is an interconnecting cable issue. If the readings are as expected, the temperature measurement circuitry in the RHE transmitter may be defective.

6.4.3.2 SoftError, Bit 3: Tube Temperature Reading Error

The Tube Temperature Sensor is always present in the system. Check the wire connections on terminals 3, 4 of the RHM sensor and the respective RHE transmitter terminals. If all connections are the correct color, are tightened properly and are making proper contact, disconnect the cable at the RHM side and measure the resistance between terminals 3 and 4 (and 3 and 5 in the case of a 12-terminal junction box). In both cases, a value between 800 and 3000 Ohms for Pt1000 and 80 and 300 Ohms for Pt100 temperature sensors (depending upon the actual temperature of the sensor) should be read. If these readings are open/short circuit or indicating some other, out of range value, the temperature sensor in the RHM flow sensor is defective.

If these readings are in specification, re-connect the wires to terminals at the RHM and disconnect the respective wires from the terminals at the RHE transmitter. Measure the resistance between the cables that are connected to RHM terminals 3 and 4 (and 3 and 5 for a 12-terminal junction box). Almost identical results to the measurements made at the RHM terminals is expected. If this is not the case, it would suggest that there is an interconnecting cable issue. If the readings are as expected, the temperature measurement circuitry in the RHE transmitter may be defective.

6.4.3.3 SoftError, Bit 22: Sensor not (yet) ready

Bit 22 in the SoftError register summarizes all RHM flow sensor drive and pickup coil related problems and is accompanied by at least one of bits 12, 13, 14, or 17 in the same register. As it takes a few moments after power-up for sensor oscillations to stabilize, these error indications are normal for a few seconds after a power cycle of the RHE transmitter.

If the error indication persists for longer than expected, the wiring between the RHE transmitter and the RHM sensor must be checked at each end for color, tightness and proper contact. If no connection problems are found, disconnect the wiring from terminals 1, 2 and 6 – 9 at the RHM sensor. Check the resistance between the RHM terminals as listed in Table 5 below.

Sensor Terminal	Resistance
1 – 2	10 ... 50 Ohm
6 – 7	10 ... 120 Ohm
8 – 9	same as 6 – 7
1, 2, 6 – 9 to case	> 10 Mohm – ∞

Table 5: Resistances between different sensor terminals

If any of your measurements are outside of the given ranges, the RHM sensor may be defective. Contact Rheonik service for assistance.

If all resistances are within specification, re-connect the wiring at the RHM sensor and disconnect the same wires at the RHE transmitter. Repeat the measurements on the cable ends. If the results deviate much from the previous measurements at the RHM terminals, the interconnecting cable is the cause of the problem.

When no problem is found with the RHM sensor or the interconnecting cabling, the RHE transmitter may be defective. In preparation for a call with Rheonik service, reconnected all wiring, power up the transmitter and measure the AC voltages between the terminals listed in Table 6 below. Write down the measured voltages.

Sensor Terminal	Voltage
1 – 2	91pprox.. 0.7 VAC (eff)
6 – 7	10...120 mVAC (eff)
8 – 9	same as 6 – 7

Table 6: Voltages for different sensor terminals

These measurements are best done with an oscilloscope. Expect an AC sine-wave signal between 80 and 250 Hz. If the proper signals are present, the signal processing path of the pick-up coils inside the RHE transmitter is most likely the problem and a reprogramming of the CPLD is recommended. If reprogramming does not resolve the problem, the RHE transmitter drive circuitry is likely defective and the transmitter will need to be returned to the factory for repair.

6.4.4 The Green LED is Off

The green LED will usually be lit within two seconds after power up. It will be extinguished for a similar time after system reset, e.g. when a new parameter is uploaded via the RHEComPro “Upload to RHE” function.

When the green LED stays off for longer than a few seconds, the most likely problem is with the power supply. Check the power supply connections at terminals 23 and 24 for polarity, tightness and proper contact. Measure the applied voltage across these terminals – the transmitters of the RHE20 series need a continuous regulated power supply of 24Vdc at 5Watts or more.

If the power supply is correct and the green LED still remains off, a defect with the RHE transmitter can be assumed and it should be sent to the factory for repair.

6.5 Important Notes on Returning Equipment to the Factory

Flow sensors which are returned to the factory will only be accepted if prior arrangements have been made and an RMA has been issued. The following conditions must be observed:

- A sensor is only accepted for repair if it is completely clean and has open process connections. In the case where sensors are returned with connections that are closed with

blind plugs or even adhesive tape, it will be assumed that process material is still in the sensor and the sensor will be returned unopened. Certification of decontamination must always be enclosed with the flow sensor (this form can be obtained from Rheonik) along with a detailed description of the error and full disclosure of the chemical, physical and toxicological properties of the process fluid the meter has been used on. An MSDS (material safety data sheet) should also be included.

- The external housing, electrical connection boxes and any auxiliary components must also be cleaned and free from any contamination.
- Any process connections screwed into or bolted onto the sensor connections must be removed before shipment. Voids behind these connections must be fully cleaned.
- Flow meters used for measuring radioactive matter or that cannot be fully freed of carcinogenic matter may not be sent in for repair.
- Note that all sensor housings are factory sealed. Breaking seals and/or removing the sensor cover invalidates warranty.
- It is recommended that you also send back a complete sensor-transmitter pair so that both devices can be tested together and exactly tuned to each other.

Appendix A The Coriolis Principle

A specific inertial force, now known as the Coriolis Effect, was first observed and mathematically described by the French scientist Gaspard-Gustave de Coriolis around 1835. The Coriolis Effect is best described as a deflection of a moving object when viewed in a rotating reference frame. From the 19th century onwards, the Coriolis Effect has helped in a wide range of engineering and natural sciences: meteorology, ocean circulations, hydraulics, machine performance, ballistic missile trajectories and flow measurements. In general, all Coriolis meters oscillate and the mass going through creates a Coriolis force. This force causes very small deflections in the tube system which are measured and used to derive mass flow rate.

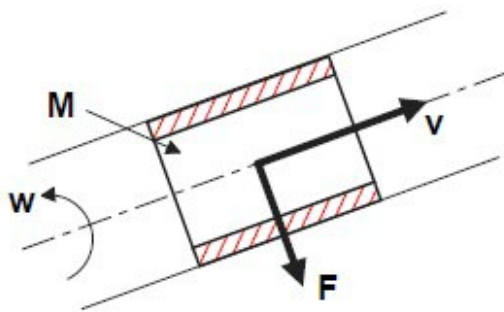

M = Mass of moving element
(liquid or gas) in pipe
 F = Coriolis Force
 v = velocity of mass moving
 w = oscillation velocity

$$F = 2 * M * v * w$$

Coriolis meters offer a number of advantages over other technologies:

- They can measure liquid or gas
- No moving parts – no wear
- Long life, minimal maintenance = low total cost of ownership
- Direct mass reading – no need for normalization of temperature or pressure
- Accuracy levels to 0.1%
- No influence by viscosity and density changes
- No flow profile issues (eliminating the need for flow straighteners/conditioners or upstream/downstream straight runs) (space saving, cost saving)

Appendix B Transmitter Maintenance

When the role “Service” is selected for the RHEComPro software program an extensive Maintenance Menu.

Via submenu items of this menu, amongst others the following functionality is offered:

- Support for meter Calibration Procedure
- Download of new CPLD Logic to the RHE transmitter
- Calculate the Passcodes for HMI or Modbus Login

These functions are described in the next subsections. Descriptions of further RHEComPro maintenance functions are found in the RHEComPro Suite User Manual.

B.1 Passcode Calculator

A User or Service Login into the RHE transmitter via HMI or Modbus interface requires the entry of passcodes. These passcodes depend on the serial number of the RHE transmitter. When the “Passcode Calculator” function is selected via the “Maintenance” / “Standard Maintenance Activities” / “Passcode Calculator” menu item, following dialog box appears:

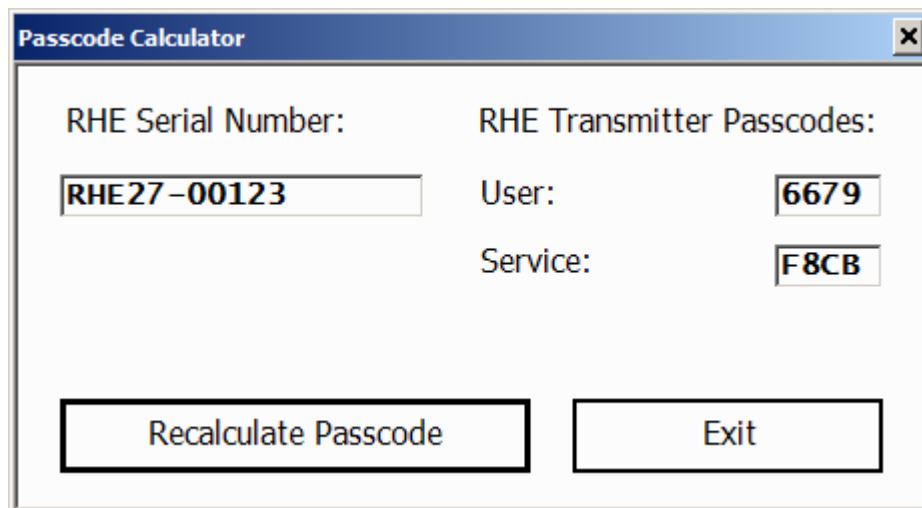

Passcode Calculator	
RHE Serial Number:	RHE Transmitter Passcodes:
<input type="text" value="RHE27-00123"/>	User: <input type="text" value="6679"/>
	Service: <input type="text" value="F8CB"/>
<input type="button" value="Recalculate Passcode"/>	<input type="button" value="Exit"/>

Figure 24: Passcode Calculator Dialog Box

This function reads a serial number out of an attached RHE transmitter – if attached – and calculates the User and Service Passcodes. The string in the “RHE Serial Number” field may be edited to a serial number of another transmitter and the respective passcodes are calculated and displayed when the “Recalculate Passcode” button is pressed.

Note that there actually are two User Passcodes valid for an RHE transmitter. The first passcode is calculated out of the serial number. The other passcode is stored in the Modbus holding register UserPassword (0x6004). This passcode is initialized to the string “1111” and may be changed by the user. Thus, a user may change a forgotten password stored in the RHE transmitter with the help of the calculated passcode.

B.2 Density Calibration

The RHE transmitter may determine the density of the substance contained in the tube of the RHM sensor by using the effect that the frequency of the sensor drops when the weight of the filled-in substance increases. The higher the density of the substance the lower the frequency of the sensor

becomes. The accuracy of the density calculation depends on the sensitivity of the RHM sensor concerning weight differences and the compensation of the temperature effect on the frequency.

RHM sensors ordered with the density calculation feature are pre-calibrated at the factory. The frequencies of the sensor filled with air and filled with water is measured and entered into the setup parameters of the RHE. Other calibration points are available on request. The density of the air is 1.2kg/m^3 and the density of water at 20°C is 998.2kg/m^3 . Since the “air” reference frequency is determined at 20°C (or recalculated to this reference) any further density calibration should be done close to this temperature, as well, in order to keep the two reference frequencies comparable. The RHEComPro program allows a compensation of a temperature difference to the reference temperature. Please consult the Rheonik Service if your process temperatures deviate much from the 20°C reference temperatures.

This is considered a two-point calibration and is usually done at the factory, but may also be done at the customer site. When a two-point calibration parameter set already exists in the RHE a customer may consider the adaption of the density calculation parameters with the help of the Simple Density Field Calibration feature described in section B.3.

Note, that an active Simple Density Field Calibration inside the RHE will render any change of the Two-Point calibration ineffective. In order to deactivate the Simple Density Field Calibration, set the parameter DnsKFactor (0x684A) to 0. This can be done with the help of the dialog box described in section B.3.

When used in the role Service the RHEComPro programs offers the ability to change the density calibration information with the help of a dedicated dialog box. This can be activated by selecting the menu „ Maintenance“ / “Advanced Maintenance Activities“ / “Two-point Density Calibration”. After having selected this menu item the following dialog box appears:

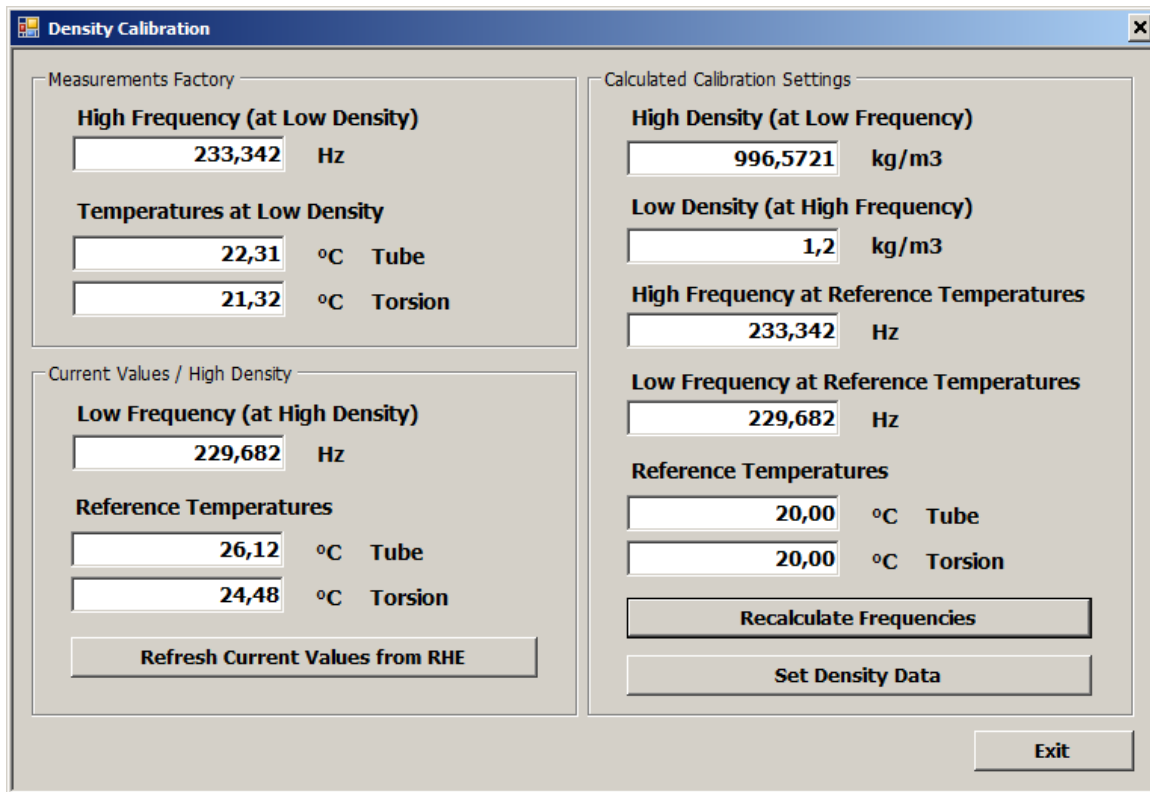

Figure 25: Two-Point Density Calibration

The values in the fields in the upper left box “Measurement Factory” such as „High Frequency“ and the Temperatures at „Low Density“, as well as the “Low Density“ field to the right are taken from the current calibration information inside the setup parameters. These can be overwritten when the RHM production information is present.

Since this dialog box assumes that the sensor is filled with the substance for the high density calibration reference point – usually water – the values in the lower left box “Current Values” such as “Reference Temperatures“ and „Low Frequency“ are determined by the current state of the RHM sensor. From these temperatures the density of pure water is calculated and automatically entered into the “High Density” field at the right side. The button “Refresh Current Values ...” will re-read the current state measurements from the RHE and allow a monitoring whether the RHM is in a stable state.

The “High Density” field may be overwritten when the density of the substance inside the RHM is known.

The “Reference Temperatures” field in the right “Calculated Calibration Settings” box may also be overwritten when desired. This only makes sense when the process temperature of the substance is much different from the standard 20° C.

Before the density calibration information is written the button “Recalculate Frequencies” must be pressed. This cause a correction of the frequencies from their original reference temperatures to the reference temperatures shown in the calibration data set.

As a final step a press on the “Set Density Data” button will write the calibration data set into the RHE setup parameters activate them via a system reset.

Note that the density calculation in the RHE transmitter is activated only when it is configured properly in the setup parameters, i.e. „VolDensPresent“ in „Generic“ is set to 1 and „DnsConfig“ in

„Density“ is set to 1. Usually these values are set at the factory when the RHE transmitter is ordered with the density calculation option.

The “Density Calibration” dialog box may be closed by clicking on the “Exit” button.

B.3 Simple Density Field Calibration

A simplified density calibration is available since the release 1.80 of the RHE firmware when the Service role has been selected and the density is calculated from the RHM frequency (DnsConfig is 1). There is a separate parameter set for the simple density calibration which is automatically filled with meaningful values originating from the two-point calibration when the Density K-Factor parameter in register DnsKFactor (0x684A) is 0.

Note: This form of density calibration yield the best results when the RHM sensor is filled with the standard processing substance and in a stable condition, i.e. the process temperature was applied for a longer time span which causes the tube and torsion temperatures inside the RHM to adjust to a near constant value.

The Simple Density Field Calibration feature may be selected via “Maintenance” / “Advanced Maintenance Activities” / “Density Field Calibration”.

After the selection of this submenu item the following dialog box appears:

Field Density Calibration Parameters in RHE		Calibration Parameters set by Factory	
Offset Frequency	234,659 Hz	High Frequency	234,659 Hz
Offset Density	1,2 kg/m3	Low Density	1,2 kg/m3
Density K-Factor (Gain)	0 *10 ⁹ kg/m ³ s ²	Low Frequency	232,463 Hz
		High Density	998,2 kg/m3

Field Calibration Density Reference Points			
<input type="checkbox"/>	Density		
	indicated by RHE	Reference Value	
First/Lower Density Reference Point	1,2	1,2	kg/m3
High Density Reference Point	998,2	998,2	kg/m3

Calculated Field Density Calibration Parameters		
Offset Frequency	234,659 Hz	Update Field Density Parameters in RHE
Offset Density	1,2 kg/m3	
Density K-Factor (Gain)	2,89211 *10 ⁹ kg/m ³ s ²	

Buttons: Revert to Factory Density Calibration, Exit, Recalculate Field Density Parameters, Update Field Density Parameters in RHE

Figure 26: RHEComPro Density Field Calibration Dialog Box

The contents of the dialog box shown in Figure 26 is typical when the simple density calibration was not activated, yet, and its parameters are taken from the existing two-point calibration.

Before changing any calibration parameter the user should be aware that there are two options. In most cases it suffices to adapt the “First/Lower Density Reference Point” parameters in order to adjust a density offset. Any modification of both density reference points should be done with care and after the consultation of the Rheonik Service as this step also modifies the slope resp. gain of the density calculation. Both reference points can be modified when the “Two Density Reference Points” check box is activated.

The effect of a modification of any parameter in this dialog box (fields with white background) can be seen in the “Calculated Field Density Calibration Parameters” field when the button “Recalculate Field Density ...” is pressed. Thus, any modification can be observed before it is committed. Any modification should not change the values in this box too much.

Each reference point consists of a pair of values. In the column “Indicated by RHE” the density for a substance is entered as it is indicated by the RHE transmitter. In the column “Reference Value” the known or otherwise determined density of the substance is entered. When using two different substances the densities of both substances should be substantially different like light oil and water or air and water.

After the input of the reference points the “Recalculate Field Density ...” button must be pressed in order to calculate the parameters of the Density Field Calibration. A plausibility check will make sure that the parameters are meaningful and inform the user when a problem is detected.

After the recalculation the newly determined density parameters by be loaded into the RHE transmitter and activated with the help of the “Update ... in RHE” button.

As with other RHE setup parameters a misconfiguration may render an entire feature useless. Should this happen here, press the “Revert to Factory ...” button. This causes the RHE to revert all parameters of the simple calibration to values derived from the two-point calibration. Thereafter, these parameters may be modified correctly. This step also must be done before a new two-point density calibration, see section B.2, is performed.

Appendix C HMI Menu Structure

Repeated from section 3.3 are the notes for Firmware Release 2.07: Starting with the Firmware Release 2.07 the HMI has been revised in accordance with customer feedbacks. Skipping parameters which are not used in a previously selected configuration and skipping whole menus for unavailable interfaces or features was the first main improvement. So not all parameters or menus listed in this appendix section are offered to be modified when RHEs or selected configurations do not need them. This shortens the list of all possible parameters considerably to a list of meaningful parameters. The identification displayed on the right upper side of the display is a recommended aid to navigate parameters in configuration menus.

The second improvement was done to the Quick Setup Menu. This menu has been extended to include the basic parameterization of the available I/O Interfaces. Furthermore, within the Quick Setup Menu the conclusion of an input of a parameter value automatically will start the input of the next meaningful parameter. This chain of parameter inputs may be suspended by pressing the ESC key when needed. Thereafter, the navigation inside menus proceeds as usual.

The following subsections describe the menu structure of the RHE20 HMI. Aside from the top-level menu there are sub-menus, data display screens, parameter input screens, and special purpose screens. In the diagram below the top-level menu items are found in the left-side in banner-like boxes. The sub-menus are shown in boxes with rounded corners.

All other menu items as depicted as boxes with square corners. All setup parameter input items bear an identification in brackets. This identification consists of a letter followed by a two-digit number and it can be used to find the description of the corresponding Modbus holding register in Appendix D. The arrows in the diagram below demonstrate the navigation through the menu levels with the help of the buttons marked in italic letters near the arrows.

In the diagrams in the next subsections only the arrow for the ENTER button is shown in order to keep the depiction simple and intuitively understandable.

Menu items marked with an asterisk '*' will appear only when a respective hardware or software option is present.

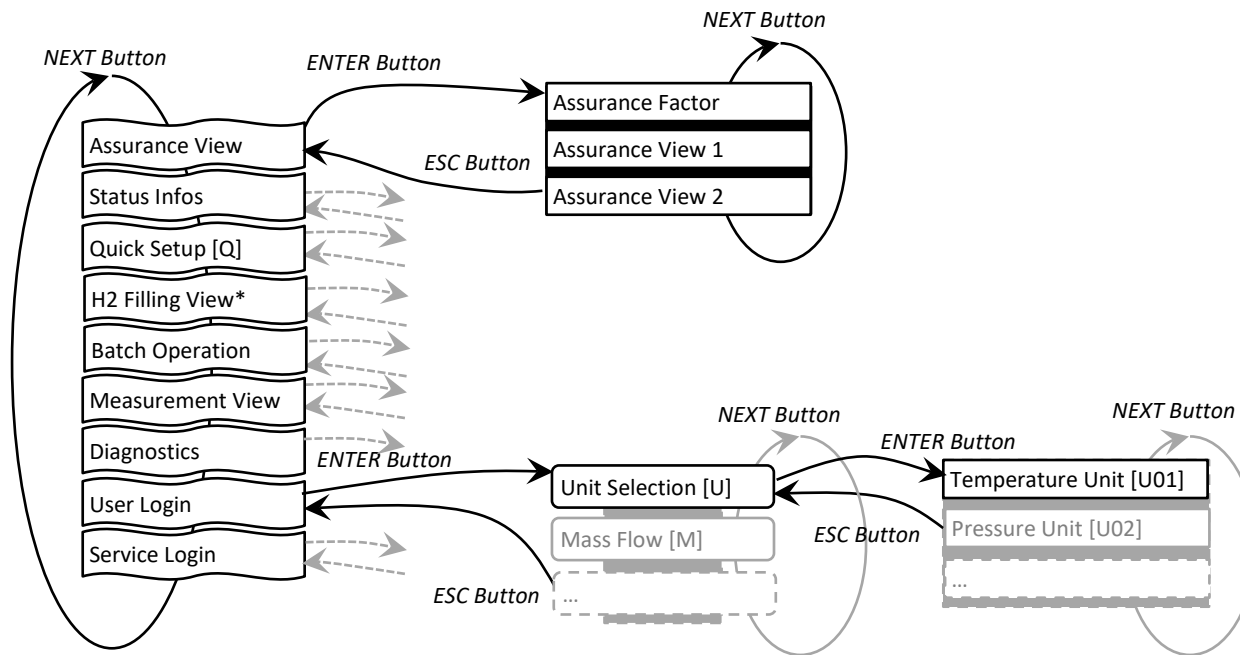

C.1 Assurance View

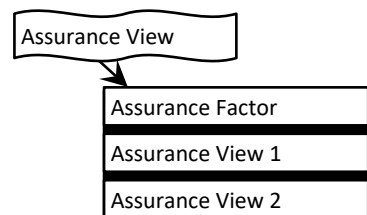

C.2 Status Infos

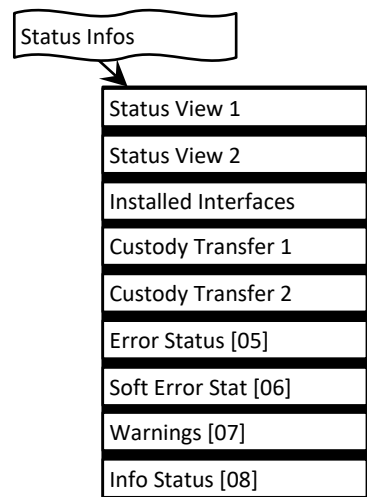

C.3 Quick Setup

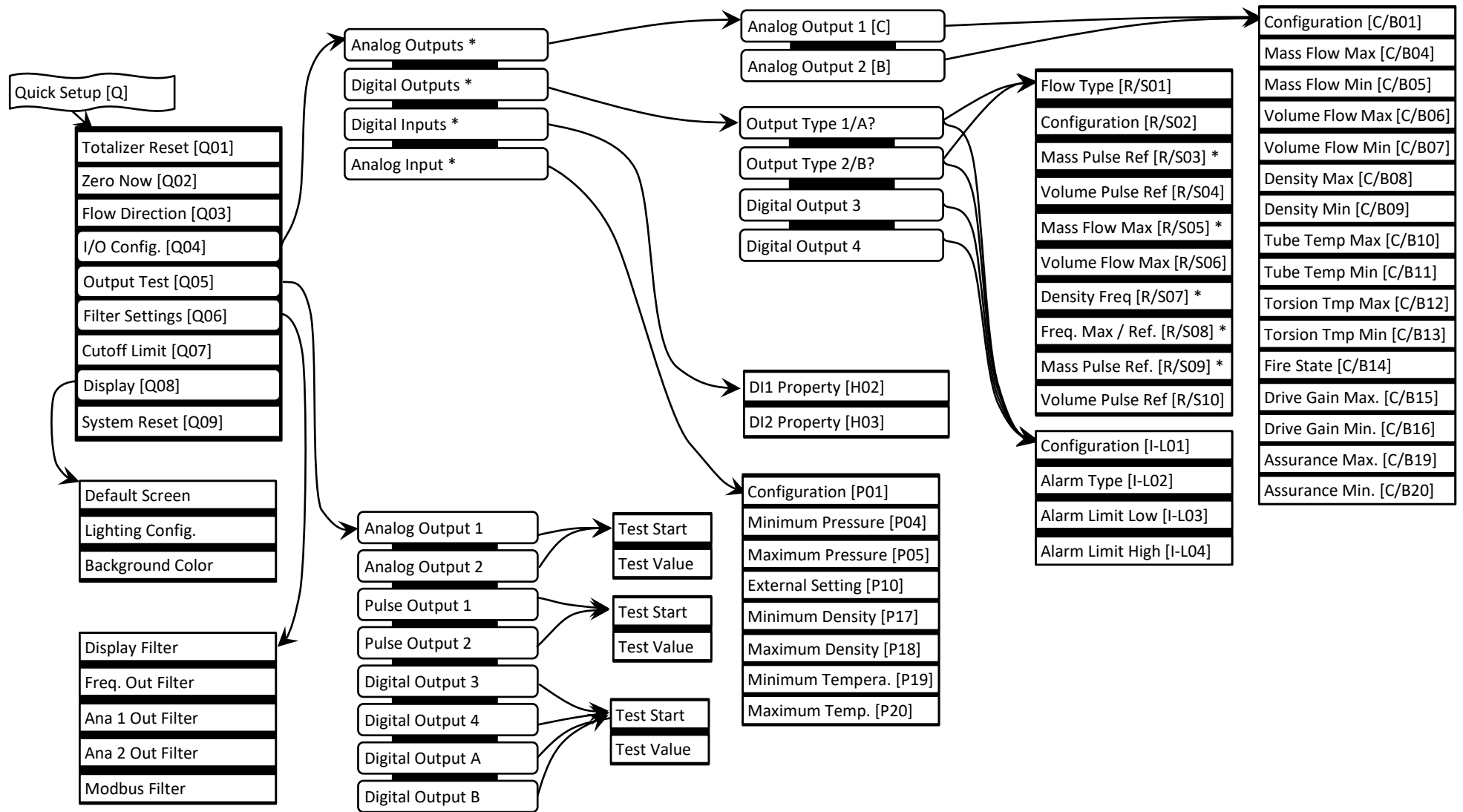

C.4 Batch Operation

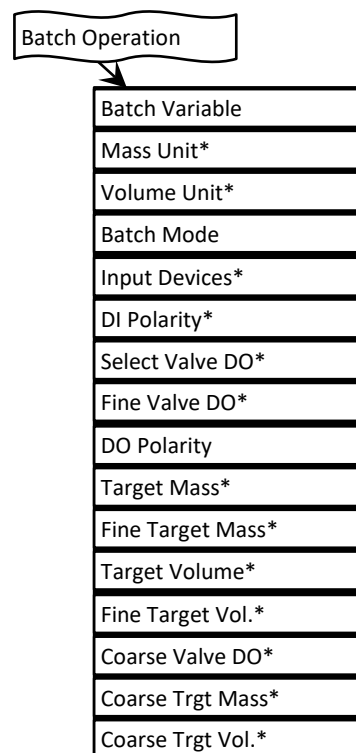

Note that the user is guided through this menu and only menu items appear that fit to the selections made for previous menu items. A mass or a volume oriented batch operation may be defined and a single or a dual valve configuration may be chosen. In order to cause a modification of the respective setup parameters the last menu item, either “Target Mass/Volume” or “Coarse Trgt Mass/Vol.” must be confirmed by the Enter key.

C.5 Measurement View

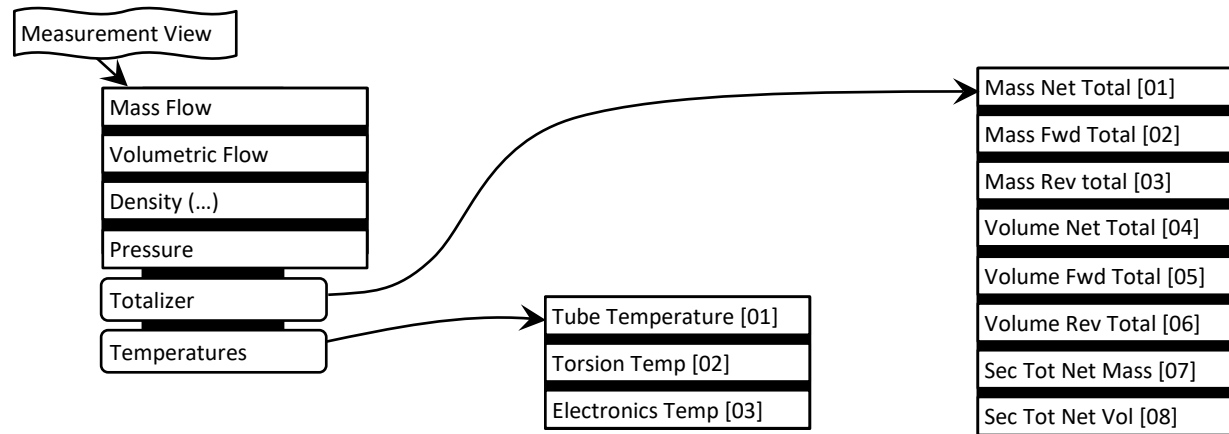

C.6 Diagnostics

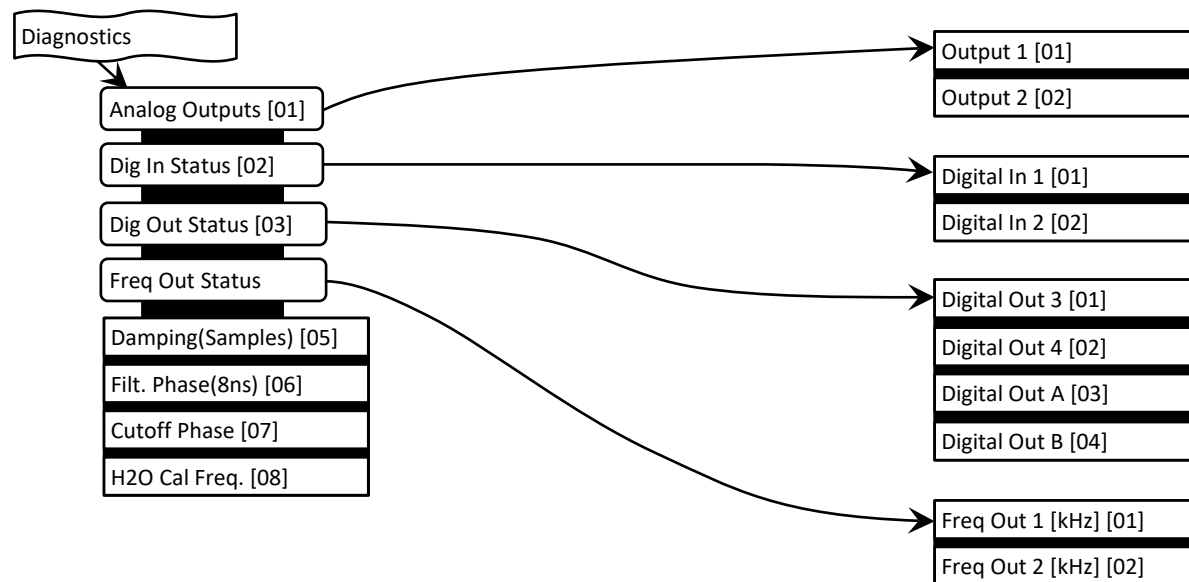

C.7 User Login

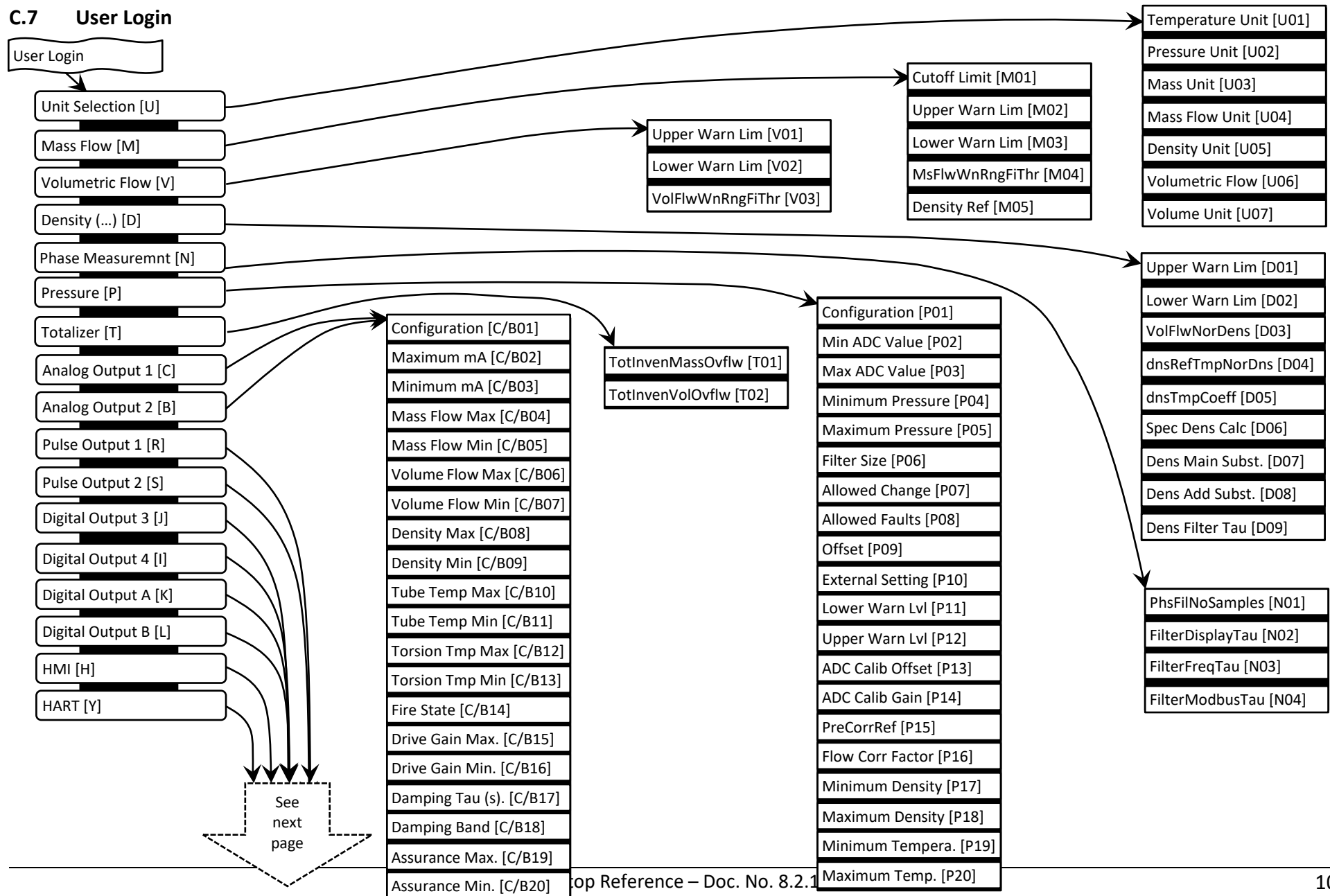

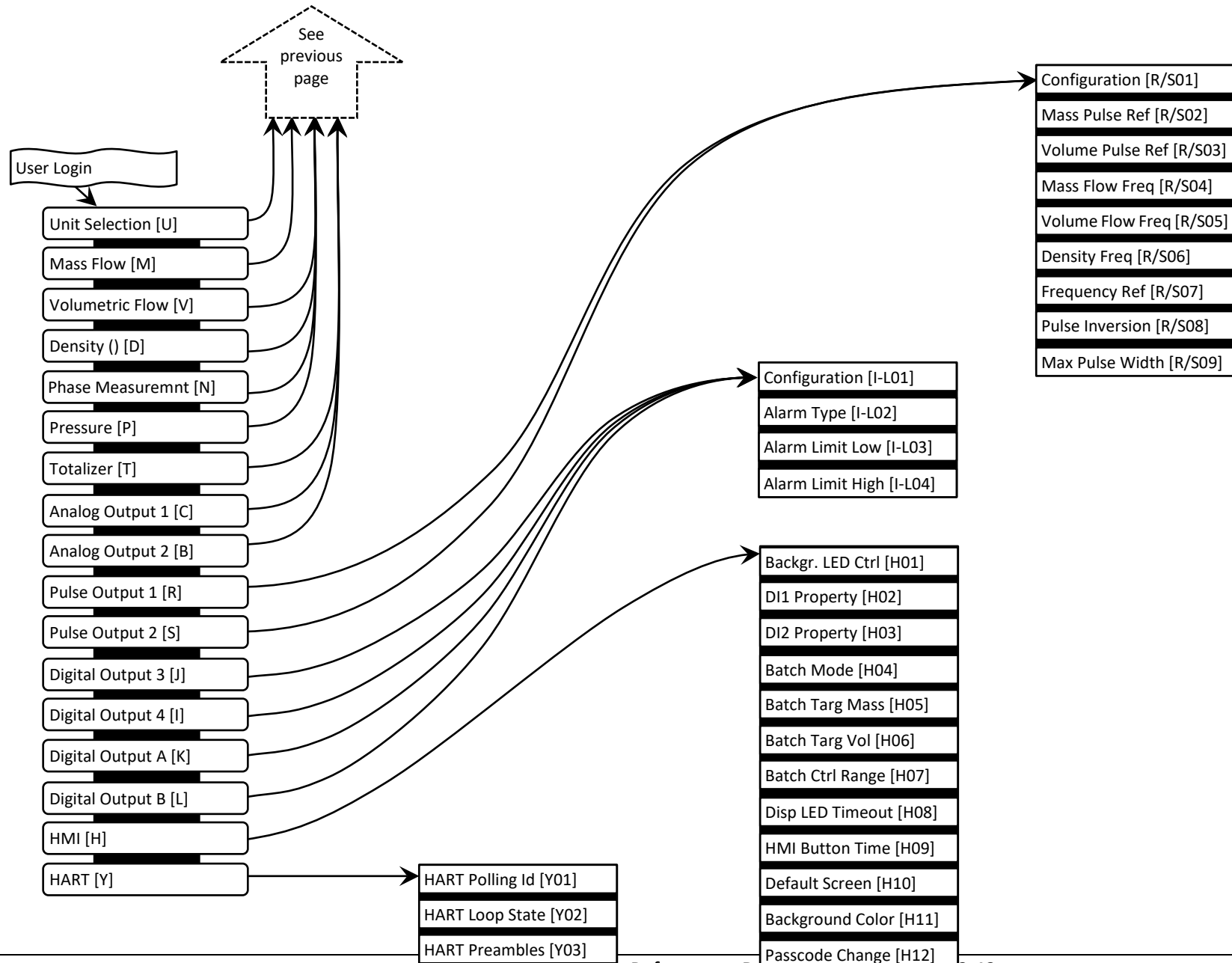

C.8 Service Login

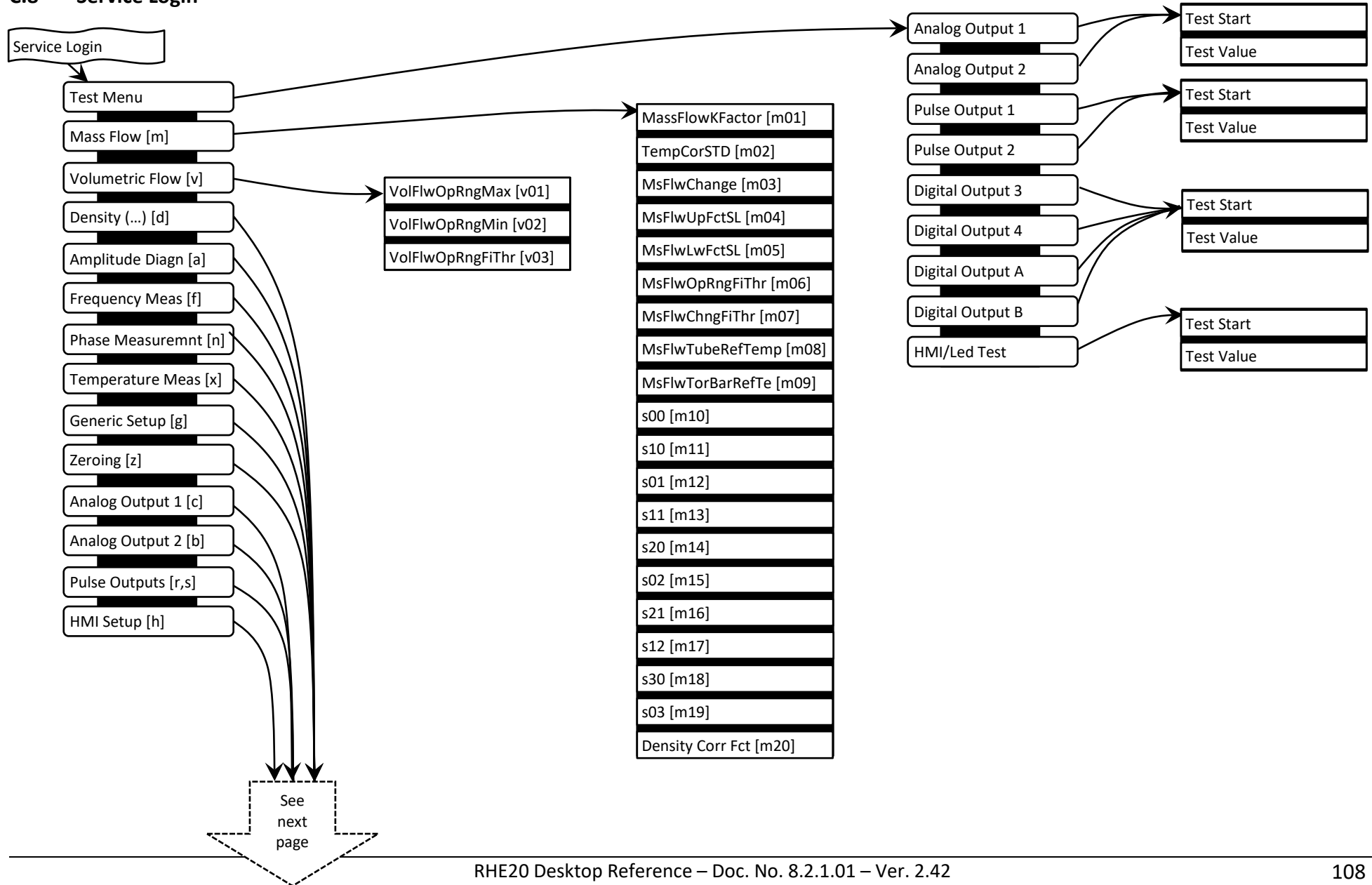

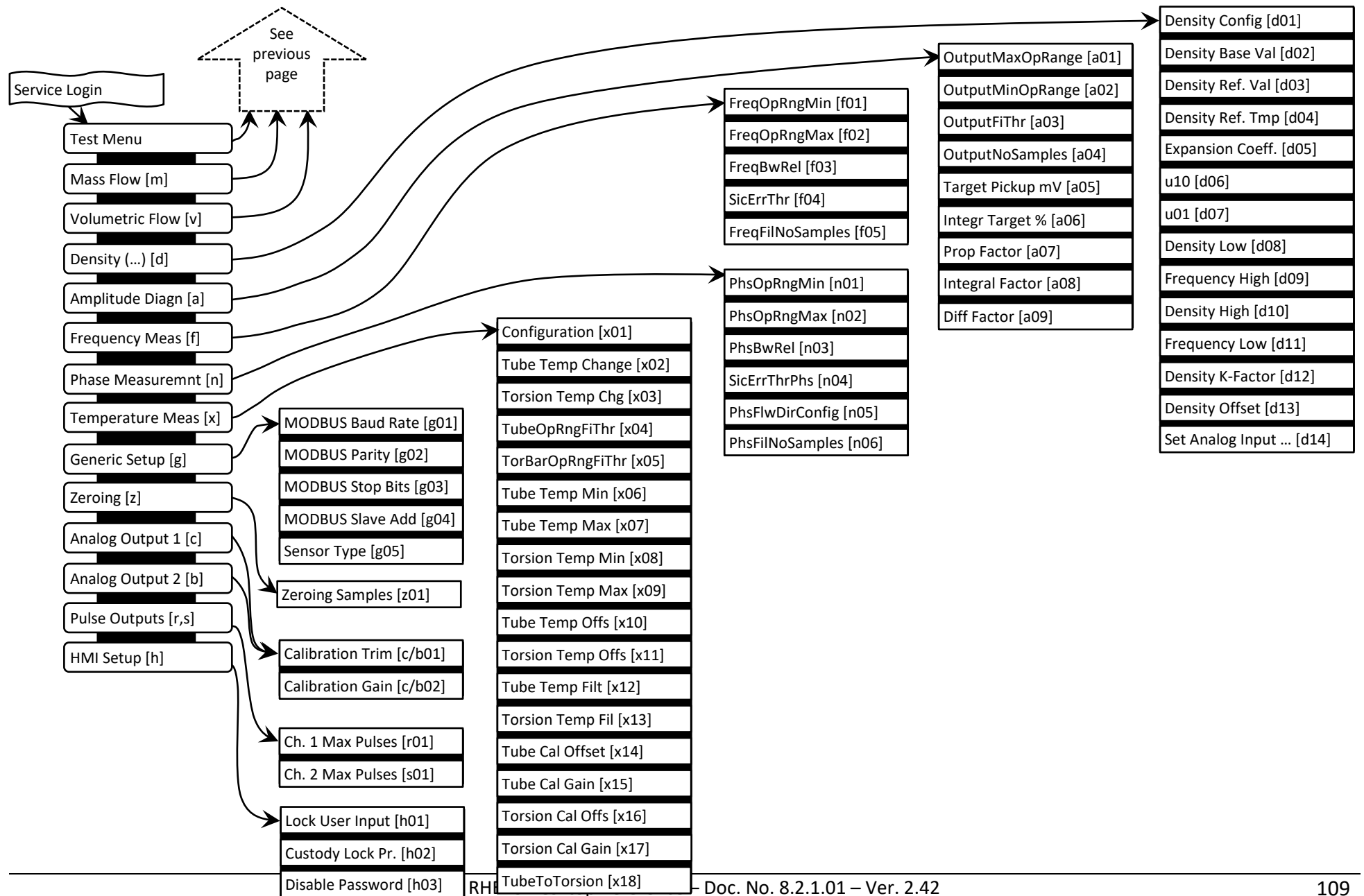

Appendix D MODBUS Register Map

As described in section 2.2 the RHE20 combines two 16-bit MODBUS registers for a 32 bit data item on an even MODBUS address and these pairs must be read together. The interpretation of the data item and the possible need for a byte-swap depends upon type. MODBUS holding registers contain the RHE transmitter setup parameters. MODBUS input registers contain measured values and status information for the RHE transmitter. MODBUS addresses are specified as a hexadecimal number identified by the “0x” prefix.

MODBUS holding registers are located in the address range 0x6000 to 0x6FFE. MODBUS input registers are located in the address range of 0x4000 to 0x4FFE. These address ranges are subdivided into functional groups such as Volumetric and Mass Flow. These functional groups are described in the subsections below where they are structured in accordance login access levels.

Table entries for Modbus holding registers which may be modified via the RHE20 HMI also show the HMI identification visible on the right upper corner of the HMI in addition to the Modbus address. For example the Cutoff Limit in the Mass Flow parameter set at Modbus address 0x6924 shows the HMI identification “M01” in brackets. Thus, a user can look up the function of a parameter seen in the HMI in the Modbus register map below and is able to find the detailed description referring to it.

Sets of mixed MODBUS input registers intended for fast multiple register access are found in the address range 0x5000 to 0x5FFE. The RHE20 register map is based on the RHE16 Modbus Register Map and was extended where additional functionality was added. The extensions are added to the ends of the respective address ranges. In order to mark features which are introduced with the RHE20 series transmitters the mark “(RHE20)” is used in the descriptions below.

D.1 Mass Flow Rate

The Mass Flow Rate is the main measurement result of the RHE20. The MODBUS holding registers of this group are intended to hold the necessary calibration values, to control the behavior of the Mass Flow measurement, and to allow the definition of error and warning limits. The MODBUS input registers of this group consist of the current Mass Flow Rate and applied temperature correction factor(s).

When supplied as a complete system (transmitter plus sensor), the RHE20 is calibrated with its sensor and supplied with setup parameters and calibration factors pre-installed. These calibration parameters should not be modified. The setup and calibration values for each sensor are recorded on the calibration certificate supplied with each unit.

Different materials of construction in the sensor react differently to temperature change. The temperature coefficient(s) set in the RHE transmitter must tally with the value(s) on the sensor calibration certificate.

D.1.1 Mass Flow Rate – MODBUS Holding Registers

D.1.1.1 Mass Flow Rate – MODBUS Holding Registers, USER Level

Address/ID	Abbreviation	Type	Full Name / Description
0x6924 [M01] [Q04]	MassFlowCutOffLimit	FLOAT32	Mass Flow Cut-Off Limit: The flow rate will be reported as zero flow if the measured mass flow determined in a single measurement cycle (flow sensor frequency/4) falls below this value. Below this value any mass flow does not register in the totalizers. Default value is 0.01kg/min in an unconfigured transmitter. This parameter should usually be set to about 20% of the minimum measuring rate value of the attached flow sensor.
0x6926 [M02]	MsFlwUpWnL	FLOAT32	Mass flow Upper Warning Limit: User defined upper mass flow limit. A mass flow above this limit causes bit 1 in the Warnings (0x401E) input register to be set. Range is from -35000kg/min to +35000kg/min, default value is 35000kg/min (max forward flow). This value is based on the unit specified in MassFlowUnit holding register (0x6106).
0x6928 [M03]	MsFlwLwWnL	FLOAT32	Mass flow Lower Warning Limit: User defined mass lower flow limit. A mass flow below this limit causes bit 1 in the Warnings (0x401E) input register to be set. Range is from -35000kg/min to +35000kg/min, default value is -35000kg/min (max reverse flow). This value is based on the unit specified in MassFlowUnit holding register (0x6106).
0x692A [M04]	MsFlwWnRngFiThr	UINT32	Mass Flow Warning Range Fault Integrator Threshold: Mass flow Warning Delay Count – Number of consecutive times the signal must exceed the upper or lower warning limits before a warning (bit 1 in Warnings input register (0x401E) is indicated. Default value is 3 cycles (1 cycle = 10ms).
0x693E [M05]	MassFlowDensCorrRef	FLOAT32	Density Reference for Mass Flow Correction: Reference density for a density-based mass-flow correction, see also MassFlowDensCorr (0x693C). This parameter has a range from 0 to 12000 kg/m ³ and is converted from (write) or to (read) the unit specified in the DensityUnit holding register (0x6108). The default is 998 kg/m ³ .

D.1.1.2 Mass Flow Rate – MODBUS Holding Registers, SERVICE Level

Address	Abbreviation	Type	Full Name / Description
0x6900 [m03]	MsFlwChange	FLOAT32	Mass Flow Change: The maximum magnitude of mass flow change from one reading to the next (at flow sensor frequency/4) to be considered normal operation. If change in mass flow rate is greater than this value, a warning is indicated (Bit 31 in the Warnings (0x401E) input register is set). Default value is 100kg/min. This value is based on the unit specified in MassFlowUnit holding register (0x6106).

Address	Abbreviation	Type	Full Name / Description
0x6902 [m04]	MsFlwUpFctSL	FLOAT32	Mass flow Upper Functional Safety Limit: Mass flow functional upper spec limit – if the mass flow rate exceeds this value a warning is indicated (Bit 8 in in the SoftError (0x401C) input register). Range is from -35000 to +35000 kg/min, default value is 35000kg/min. This value is based on the unit specified in MassFlowUnit holding register (0x6106). This value is set by factory configuration depending on the attached RHM sensor.
0x6904 [m05]	MsFlwLwFctSL	FLOAT32	Mass flow Lower Functional Safety Limit: Mass flow functional lower spec limit – if the mass flow rate is less this value a warning is indicated (Bit 8 in in the SoftError (0x401C) input register). Range is from -35000 to +35000 kg/min, default value is -35000kg/min (backward flow). This value is based on the unit specified in MassFlowUnit holding register (0x6106). This value is set by factory configuration depending on the attached RHM sensor.
0x6906 [m06]	MsFlwOpRngFiThr	UINT32	Mass Flow Rate Operating Range Fault Integrator Threshold: Number of consecutive times (based on a flow sensor frequency/4 cycle) the mass flow measurement must exceed the upper and lower functional safety limits before a warning (Bit 8 in in the SoftError (0x401C) input register) is indicated. Default value is 3 cycles.
0x6908 [m07]	MsFlwChngFiThr	UINT32	Mass Flow Rate Change Fault Integrator Threshold: Number of consecutive cycles (based upon 1 cycle = flow sensor frequency/4) mass flow change must exceed max change limit before a warning (Bit 31 in the Warnings (0x401E) input register) is indicated. Default value is 3 cycles.
0x690A [m08]	MsFlwTubeRefTemp	FLOAT32	Mass Flow Rate Reference Temperature Tube: Reference Tube Temperature used in Mass Flow Calculation. This value is used when a Tube Temperature Sensor is present and will be 0.0 when no tube temperature sensor is configured (see bit 0 in TempConfig (0x6500)). This value originates from the initial setup/calibration process of the sensor. Default value is 20 degrees Celsius. This value based on the unit specified in TemperatureUnit holding register (0x6100).
0x690C [m09]	MsFlwTorBarRefTemp	FLOAT32	Mass Flow Torsion Bar Reference Temperature: Reference Torsion Bar Temperature used in Mass Flow Calculation. This value is used when a Torsion Bar Temperature Sensor is present and will be 0.0 when no torsion bar temperature sensor is configured (see bit 1 in TempConfig (0x6500)). This value originates from the initial setup/calibration process of the sensor. Default is 20 degrees Celsius. This value is based on the unit specified in TemperatureUnit holding register (0x6100).
0x690E [m10]	s00	FLOAT32	Mass Flow Rate coefficient for Constant Factor term: Basic constant of Quick Tcor Compensation. This value originates from the initial setup/calibration process of the sensor.
0x6910 [m11]	s10	FLOAT32	Mass Flow Rate coefficient for Term T1 (tube temperature in degree Celsius): Coefficient of Quick Tcor Compensation. Mass Flow Rate coefficient for Term T1 (torsion bar temperature in degree Celsius). This value originates from the initial setup/calibration process of the sensor.

Address	Abbreviation	Type	Full Name / Description
0x6912 [m12]	s01	FLOAT32	Mass Flow Rate coefficient for term T2: Coefficient of Quick Tcor Compensation. Mass Flow Rate coefficient for Term T2 (torsion bar in degree Celsius). This value originates from the initial setup/calibration process of the sensor.
0x6914 [m13]	s11	FLOAT32	Mass Flow Rate coefficient for term T1 * T2: Coefficient of Quick Tcor Compensation. Mass Flow Rate coefficient for Term T1*T2. This value originates from the initial setup/calibration process of the sensor.
0x6916 [m14]	s20	FLOAT32	Mass Flow Rate coefficient for term T1 * T1: Coefficient of Quick Tcor Compensation. Mass Flow Rate coefficient for the term T1*T1. This value originates from the initial setup/calibration process of the sensor.
0x6918 [m15]	s02	FLOAT32	Mass Flow Rate coefficient for term T2 * T2: Coefficient of Quick Tcor Compensation. Mass Flow Rate coefficient for the term T2*T2. This value originates from the initial setup/calibration process of the sensor.
0x691A [m16]	s21	FLOAT32	Mass Flow Rate coefficient for term T1 * T1 * T2: Coefficient of Quick Tcor Compensation. Mass Flow Rate coefficient for the term T1*T1*T2. This value originates from the initial setup/calibration process of the sensor.
0x691C [m17]	s12	FLOAT32	Mass Flow Rate coefficient for term T1 * T2 * T2: Coefficient of Quick Tcor Compensation. Mass Flow Rate coefficient for the term T1*T2*T2. This value originates from the initial setup/calibration process of the sensor.
0x691E [m18]	s30	FLOAT32	Mass Flow Rate coefficient for term T1 * T1 * T1: Coefficient of Quick Tcor Compensation. Mass Flow Rate coefficient for the term T1*T1*T1. This value originates from the initial setup/calibration process of the sensor.
0x6920 [m19]	s03	FLOAT32	Mass Flow Rate coefficient for term T2 * T2 * T2: Coefficient of Quick Tcor Compensation. Mass Flow Rate coefficient for the term T2*T2*T2. This value originates from the initial setup/calibration process of the sensor.
0x6922 [m01]	MassFlowKFactor	FLOAT32	Mass Flow K-Factor: K-Factor of the Mass Flow Calculation. This value originates from the initial setup/calibration process of the sensor and is the main factor which determines the uncertainty of the sensor.
0x692C	MassFlowKFactorUSL	FLOAT32	Mass Flow K-Factor USL: Mass flow K-Factor upper linear range limit used when a correction factor is to be applied to the K-Factor depending on the current mass flow rate. The correction factor B will be used with when the current flow rate is greater than this value and MassFlowKFactorBUSL is greater than 0. This value will be converted by the unit specified by MassFlowUnit (0x6106).

Address	Abbreviation	Type	Full Name / Description
0x692E	MassFlowKFactorB	FLOAT32	Mass Flow K-Factor B: The correction factor B is applied to the K-Factor when the mass flow rate is in the range of MassFlowKFactorUSL and MassFlowKFactorBUSL. The resulting correction factor is interpolated in this range starting with 1.0 and ending with the value of this parameter. The range of this parameter is from 0.75 to 1.5 and the default value is 1.0.
0x6930	MassFlowKFactorBUSL	FLOAT32	Mass Flow K-Factor BUSL: Mass flow K-factor upper operating range used when the correction factor B is to be applied to K-Factor depending on the current mass flow rate. The correction factor C will be used with when the current flow rate is greater than this value and MassFlowKFactorCUSL is greater than 0. Must be 0.0 in order to disable use of correction factor B. This value will be converted by the unit specified by MassFlowUnit (0x6106).
0x6932	MassFlowKFactorC	FLOAT32	Mass Flow K-Factor C: The correction factor C is applied to the K-Factor when the mass flow rate is in the range of MassFlowKFactorBUSL and MassFlowKFactorCUSL. The resulting correction factor is interpolated in this range starting with MassFlowKFactorB and ending with MassFlowKFactorC. The range of this parameter is from 0.75 to 1.5 and the default value is 1.0.
0x6934	MassFlowKFactorCUSL	FLOAT32	Mass Flow K-Factor CUSL: Mass flow K-factor upper operating range used when the correction factor C is to be applied to K-Factor depending on the current mass flow rate. The correction factor D will be used with when the current flow rate is greater than this value and MassFlowKFactorDUSL is greater than 0. Must be 0.0 in order to disable use of correction factor C. This value will be converted by the unit specified by MassFlowUnit (0x6106).
0x6936	MassFlowKFactorD	FLOAT32	Mass Flow K-Factor D: The correction factor D is applied to the K-Factor when the mass flow rate is in the range of MassFlowKFactorCUSL and MassFlowKFactorDUSL. The resulting correction factor is interpolated in this range starting with MassFlowKFactorC and ending with MassFlowKFactorD. The range of this parameter is from 0.75 to 1.5 and the default value is 1.0.
0x6938	MassFlowKFactorDUSL	FLOAT32	Mass Flow K-Factor DUSL: Mass flow K-factor upper operating range used when the correction factor D is to be applied to K-Factor depending on the current mass flow rate. The interpolation of the correction factor D will continue beyond this mass flow. Must be 0.0 in order to disable use of correction factor D. This value will be converted by the unit specified by MassFlowUnit (0x6106).

Address	Abbreviation	Type	Full Name / Description
0x693A [m02]	TempCorSTD	FLOAT32	<p>Factor for Simplified Temperature Correction: Set to a value different to 0.0 when no Torsion Bar Temperature Sensor is present. Default value is 0.0 (Torsion Bar Sensor present). Otherwise, the temperature correction is calculated in accordance to the formula</p> $Kfactor *= 1.0 + ((T1 - Tref) * TempCorSTD)$ <p>Historic Rheonik systems used a factor of about -0.0005 for the simplified temperature correction based on one temperature sensor.</p>
0x693C [m20]	MassFlowDensCorr	FLOAT32	<p>Density correction factor for mass flow: Density correction factor when a sensor returns density dependent measurement results. Per default no density correction is performed and this parameter is 0. The unit of this parameter is fixed to m³/t. See also MassFlowDensCorrRef (0x693E).</p>
0x6940	MassFlowDensCorrSquare	FLOAT32	<p>Square Density correction factor for mass flow: Density correction factor when an RHM sensor returns density dependent measurement results. Per default no density correction is performed and this parameter is 0. The unit of this parameter is fixed to (m³/t)².</p>
0x6942	MassFlowGradCorr	FLOAT32	<p>Temperature Gradient Correction Factor: Temperature gradient correction factor employed when the threshold in MassFlowGradThres (0x6942) is exceeded.</p>
0x6944	MassFlowGradThres	FLOAT32	<p>Temperature Gradient Correction Threshold: Threshold beyond which the temperature gradient correction is engaged. Unit is fixed °C/s.</p>
0x6946	MassFlowFlowCorrLin	FLOAT32	<p>Linear Mass Flow Flow Correction Factor: Linear Mass Flow flow correction factor.</p>
0x6948	MassFlowFlowCorrSquare	FLOAT32	<p>Square Mass Flow Flow Correction Factor: Square Mass Flow flow correction factor.</p>
0x694A	MassFlowFlowCorrRef	FLOAT32	<p>Mass Flow flow correction reference: This value is based on the unit specified in MassFlowUnit holding register (0x6106). The standard unit is kg/min.</p>

Address	Abbreviation	Type	Full Name / Description
0x694C	MassFlowCorrCtl	UINT32	<p>Mass Flow Correction Control: Allows the disabling of specific correction features. Any change of this register has an immediate effect. Each features is assigned a bit in the control word: Bit 0: If set to 1 disables the mass flow flow correction feature. Bit 1: If set to 1 disables the mass flow correction feature based on the density data. Bit 2: If set to 1 disables the mass flow correction feature based on the pressure data. By default all correction features are enabled and this register is 0.</p>

D.1.2 Mass Flow Rate – MODBUS Input Registers

D.1.2.1 Mass Flow Rate – MODBUS Input Registers, USER Level

Address	Abbreviation	Type	Full Name / Description
0x4900	MassFlowRate	FLOAT32	Mass Flow Rate: Current mass flow rate. This value is based on the unit specified in MassFlowUnit holding register (0x6106). The standard unit is kg/min.
0x4902	TempCoeffMassFlow	FLOAT32	Mass Flow Temperature Correction Factor: Current mass flow temperature correction factor value. Value depends upon the temperature correction factor and the current Tube and Torsion Rod temperatures.
0x4904	MassFlowRateDisplay	FLOAT32	(Since release 1.76) Mass Flow Rate for Display: Mass Flow after additional display-related filter which uses the time constant specified in the register FlowFilterDisplayTau (0x6366). This value is based on the unit specified in MassFlowUnit holding register (0x6106). The standard unit is kg/min.
0x4906	MassFlowRateFreq	FLOAT32	(Since release 1.76) Mass Flow Rate for Frequency Output: Mass Flow after additional frequency output related filter which uses the time constant specified in the register FlowFilterFreqTau (0x6368). This value is based on the unit specified in MassFlowUnit holding register (0x6106). The standard unit is kg/min.
0x4908	MassFlowRateModbus	FLOAT32	(Since release 1.76) Mass Flow Rate for Modbus Control Loops: Mass Flow after additional Modbus-register related filter which uses the time constant specified in the register FlowFilterModbusTau (0x636A). This value is based on the unit specified in MassFlowUnit holding register (0x6106). The standard unit is kg/min.
0x490A	MassFlowRateNoCutOff	FLOAT32	(Since release 1.76) Mass Flow Rate without Cut Off Limit: Contains the current mass flow rate and is almost identical to Register MassFlowRateModbus (0x4908), but the Cut-Off Limit in Register MassFlowCutOffLimit is not applied. This value is based on the unit specified in MassFlowUnit holding register (0x6106). The standard unit is kg/min.
0x490C	MassFlowFlowCorrFactor	FLOAT32	(Since release 2.00) Mass Flow Rate Flow Correction Factor: The mass flow flow correction factor calculated with the help of the correction constants in registers 0x6946 to 0x694A.

D.2 Volumetric Flow Rate

The RHE20 will calculate Volumetric Flow Rate from Mass Flow Rate and flow Density. Density is calculated either directly by measurement within the transmitter, by user input parameters, or obtained via the Analog Input. The MODBUS holding registers of this group are intended to control the

behavior of the Volume Flow measurement and allow the definition of error and warning limits. The MODBUS input register of this group contains the current Volume Flow.

Note that volumetric flow value is set to zero when no proper density parameter is present.

D.2.1 Volumetric Flow Rate – MODBUS Holding Registers

D.2.1.1 Volumetric Flow Rate – MODBUS Holding Registers, USER Level

Address/ID	Abbreviation	Type	Full Name / Description
0x6A06 [V01]	VolFlwUpWnL	FLOAT32	Volumetric Flow Upper Warning Limit: User specifiable maximum range for Volumetric Flow – if volumetric flow rate exceeds this value a warning is indicated (Bit 2 in in the Warnings (0x401E) input register). Default is about 7E38 m ³ /min. This value is based on the unit specified in the VolumeFlowUnit holding register (0x610A). Note that for correct calculation of Volumetric Flow, either internal density measurement must be enabled or the density value must be supplied in the MODBUS setup register VolFlwNorDens (0x6832).
0x6A08 [V02]	VolFlwLwWnL	FLOAT32	Volumetric Flow Lower Warning Limit: User specifiable minimum range for Volumetric Flow – if volumetric flow rate is below this value a warning is indicated (Bit 2 in in the Warnings (0x401E) input register). Default is -7E38 m ³ /min. This value is based on the unit specified in the VolumeFlowUnit holding register (0x610A). Note that for correct measurement of Volumetric Flow, either internal density measurement must be enabled or the density value must be supplied in the MODBUS setup register VolFlwNorDens (0x6832).
0x6A0A [V03]	VolFlwWnRngFiThr	UINT32	Volumetric Flow Warning Range Fault Integrator Threshold: Number of consecutive cycles (1 cycle = flow sensor frequency/4) Volumetric Flow Upper or Lower Warning limit must be exceeded before indicating a warning in Bit 2 of the Warnings (0x401E) input register. Default value is 3 cycles.
0x6A0C [V04]	VolumeA1warm	FLOAT32	Correction Volume A1 for Special Function 1: See extra document 8.2.1.11. The unit is fixed to cm ³ . Only available when special function 1 is activated.
0x6A0E [V05]	VolumeA2cold	FLOAT32	Correction Volume A2 for Special Function 1: See extra document 8.2.1.11. The unit is fixed to cm ³ . Only available when special function 1 is activated.
0x6A10 [V06]	VolumeB	FLOAT32	Correction Volume B for Special Function 1: See extra document 8.2.1.11. The unit is fixed to cm ³ . Only available when special function 1 is activated.

D.2.1.2 Volumetric Flow Rate – MODBUS Holding Registers, SERVICE Level

Address	Abbreviation	Type	Full Name / Description
0x6A00 [v01]	VolFlwOpRngMax	FLOAT32	Volumetric Flow Operational Range Maximum: Maximum operation range for Volumetric Flow – if volumetric flow rate exceeds this value a warning is issued (Bit 9 in in the SoftError (0x401C) input register). Range is from about -7E38m ³ /min to 7E38m ³ /min, default is about 7E38 m ³ /min. This value is based on the unit specified in the VolumeFlowUnit holding register (0x610A). Note that for correct calculation of Volumetric Flow, either internal density measurement must be enabled or the density value must be supplied in the MODBUS setup register VolFlwNorDens (0x6832).
0x6A02 [v02]	VolFlwOpRngMin	FLOAT32	Volumetric Flow Operational Range Minimum: Minimum operation range for Volumetric Flow – if volumetric flow rate is below this value a warning is issued (Bit 9 in the SoftError (0x401C) input register). Range is from about -7E38m ³ /min to 7E38m ³ /min, default is about -7E38 m ³ /min. This value based on in the unit specified in the VolumeFlowUnit holding register (0x610A). Note that for correct calculation of Volumetric Flow, either internal density measurement must be enabled or the density value must be supplied in the MODBUS setup register VolFlwNorDens (0x6832).
0x6A04 [v03]	VolFlwOpRngFiThr	UINT32	Volumetric Flow Operating Range Fault Integrator Threshold: Number of consecutive cycles (1 cycle = flow sensor frequency/4) Volumetric Flow Operational Range max or min warning condition must be exceeded before indicating a warning in Bit 9 of the SoftError (0x401C) input register. Default value is 3 cycles.

D.2.2 Volumetric Flow Rate – MODBUS Input Registers

D.2.2.1 Volumetric Flow Rate – MODBUS Input Registers, USER Level

Address	Abbreviation	Type	Full Name / Description
0x4A00	VolumetricFlowRate	FLOAT32	Volumetric Flow Rate: Current volumetric flow rate. This value is based on the unit specified in VolumeFlowUnit holding register (0x610A). The standard/default unit is m ³ /min.
0x4A02	VolFlowRateDisplay	FLOAT32	(Since release 1.76) Volumetric Flow Rate for Display: Volumetric Flow after additional display-related filter which uses the time constant specified in the register FlowFilterDisplayTau (0x6366). This value is based on the unit specified in VolumeFlowUnit holding register (0x610A). The standard unit is m ³ /min.

Address	Abbreviation	Type	Full Name / Description
0x4A04	VolFlowRateFreq	FLOAT32	(Since release 1.76) Volumetric Flow Rate for Frequency Output: Volumetric Flow after additional frequency output related filter which uses the time constant specified in the register FlowFilterFreqTau (0x6368). This value is based on the unit specified in VolumeFlowUnit holding register (0x610A). The standard unit is m ³ /min.
0x4A06	VolFlowRateModbus	FLOAT32	(Since release 1.76) Volumetric Flow Rate for Modbus Control Loops: Volumetric Flow after additional Modbus-register related filter which uses the time constant specified in the register FlowFilterModbusTau (0x636A). This value is based on the unit specified in VolumeFlowUnit holding register (0x610A). The standard unit is m ³ /min.

D.3 Density Measurement and Calculation

When the optional density feature is ordered with an RHE transmitter, the MODBUS holding registers of this group hold the necessary calibration values, control the behavior of the Mass Flow measurement and allow the definition of error and warning limits. MODBUS input registers in this group contain the current Density value and current temperature correction factor.

As an alternative to live internal density measurement, calculation of density through a normal density value together with base temperature and temperature coefficient factor, or an input of a density value via the Analog Input may also be used. The origin of the density value is controlled by the DnsConfig (0x6800) parameter.

D.3.1 Density Calculation – MODBUS Holding Registers

D.3.1.1 Density Calculation – MODBUS Holding Registers, USER Level

Address/ID	Abbreviation	Type	Full Name / Description
0x682E [D01]	DenUpWnL	FLOAT32	Density Upper Warning Limit: User defined upper limit for compensated density. When this limit is exceeded a warning is indicated – bit 0 in the Warnings (0x401E) input register is set. The default value is set to 12000kg/m ³ . This value is based on the unit specified in the DensityUnit holding register (0x6108).
0x6830 [D02]	DenLwWnL	FLOAT32	Density Lower Warning Limit: User defined lower limit for compensated density. When this limit is exceeded a warning is indicated – bit 16 in the Warnings (0x401E) input register is set. The default value is set to 0kg/m ³ . This value is based on the unit specified in the DensityUnit holding register (0x6108).

Address/ID	Abbreviation	Type	Full Name / Description
0x6832 [D03] [d02] [d03]	VolFlwNorDens	FLOAT32	Volumetric Flow Normal Density: User supplied normal initial density value up to 12000kg/m ³ used to initialize the VolFlwNorDensCurr (0x6838) register when DnsConfig (0x6800) is set to 2 and also used directly when DnsConfig (0x6800) is set to 3. The default is set to 1000kg/m ³ . This value is based on the unit specified in the DensityUnit holding register (0x6108).
0x6834 [D04] [d04]	dnsRefTmpNorDns	FLOAT32	Density Reference Temperature Normal Density: Reference temperature to the user supplied Normal Density value, see VolFlwNorDens (0x6832). The default to 20 degrees Celsius. This value is based on the unit specified in the TemperatureUnit holding register (0x6100).
0x6836 [D05] [d05]	dnsTmpCoeff	FLOAT32	Density Temperature Coefficient: User input thermal expansion coefficient for Normal Density value used when DnsConfig (0x6800) is set to 3. The default is 0.0. The compensated Density is calculated by: $DenComp = \frac{VolFlwNorDens}{(1 + dnsTmpCoeff(AdcTubeMeanTemp - dnsRefTmpNorDns))}$ in which °C representation of temperature is used. For ideal gases at 0°C this factor is 1/273.15=0.003361.
0x6838	VolFlwNorDensCurr	FLOAT32	Current Volumetric Flow Normal Density: When DnsConfig (0x6800) is set to 2 this field is initialized to VolFlwNorDens (0x6832). Any write to this register has an immediate effect in this mode and modifies the density value used to calculate the volumetric flow out of the mass flow. This value is converted from (write) or to (read) the unit specified in the DensityUnit holding register (0x6108).

Address/ID	Abbreviation	Type	Full Name / Description
0x683A [D06]	DenCalcMode	UINT32	<p>Special Density Calculation Modes:</p> <p>0: None. No special density calculation is done (default). In this case the register StdDensity (0x480A) will contain the same value as DenComp and VolPercentMainSubstance always will be 100%.</p> <p>1: API MPMS Density calculation for Crude Oil. The volume flow and total is based on the calculated standard density.</p> <p>2: API MPMS Density calculation for Refined Products. The volume flow and total is based on the calculated standard density.</p> <p>3: API MPMS Density calculation for Lubricants. The volume flow and total is based on the calculated standard density.</p> <p>4: "Net Oil" Calculation based on the Crude Oil density found in DenMainSubstance, the Water Density found in DenAddSubstance, and the implied salinity of the water. The result is found in PercentMainSubstance (0x480C) and the volume flow and total is calculated based on the portion of the main substance.</p> <p>5: % Substance calculation based on the density of the main substance found in DenMainSubstance and the density of an additional Substance found in DenAddSubstance. The result is found in VolPercentMainSubstance (0x480C). The volume flow and total is calculated based on the portion of the main substance.</p> <p>6: Calculation mode for special function 1, see extra document 8.2.1.11. Selectable only when special function 1 is available.</p> <p>7: % Substance calculation based on the density of the main substance found in DenMainSubstance and the density of an additional Substance found in DenAddSubstance. The result is found in VolPercentMainSubstance (0x480C). The volume flow and total is calculated based on DenComp, the measured density and not the portion of the main substance.</p> <p>Any special density calculation mode is only activated when the system density is determined, i.e. DnsConfig (0x6800) contains 1.</p> <p>Note: When the API Density calculation is active (DenCalcMode is 1, 2, or 3) the HMI displays the API standard density and the volume flow and volume totalizer is calculated on the basis of the API density.</p>
0x683C [D07]	DenMainSubstance	FLOAT32	<p>Density of the Main Substance:</p> <p>This value is used when DenCalcMode (0x683A) is 4 or 5.</p> <p>For DenCalcMode=4 it specifies the density of the crude oil portion at 60°F and 1bar pressure. In this case this value must be in the range of 610.6 to 1163.5 kg/m³. When this is not the case bit 13 in the ErrorStatus register is set.</p> <p>For DenCalcMode=5 it specifies the density of the main substance for the current environmental conditions.</p> <p>The value in this register is based on the unit specified in the DensityUnit holding register (0x6108).</p>

Address/ID	Abbreviation	Type	Full Name / Description
0x683E [D08]	DenAddSubstance	FLOAT32	<p>Density of an Additional Substance: This value is used when DenCalcMode (0x683A) is 4 or 5. For DenCalcMode=4 it specifies the density of the water portion at 60°F and 1bar pressure. In this case this value must be in the range of 997 to 1300 kg/m³. When this is not the case bit 13 in the ErrorStatus register is set. For DenCalcMode=5 it specifies the density of the additional substance for the current environmental conditions. The density of the additional substance may be smaller or greater than the density of the main substance and must differ from the density of the main substance by more than 10%. If this is not the case bit 13 in the ErrorStatus register is set. The value in this register is based on the unit specified in the DensityUnit holding register (0x6108).</p>
0x6848 [D09]	DenTau	FLOAT32	<p>(Since release 1.76) Density Filter Factor Tau Filter constant Tau for the density and standard density measurement results. The unit is seconds and the default is 2s.</p>

D.3.1.2 Density Calculation – MODBUS Holding Registers, SERVICE Level

Address	Abbreviation	Type	Full Name / Description
0x6800 [d01]	DnsConfig	UINT32	<p>Density Configuration: Type of density measurement: 0: Off 1: Density is calculated from sensor data. 2: Density is set to the value found in the updateable VolFlwNorDensCurr (0x6838) register which in turn is initialized from the VolFlwNorDens (0x6832) setup register. No temperature compensation is applied. 3: The temperature corrected density based in the value in the VolFlwNorDens (0x6832), the RHM tube temperature, the density reference temperature dnsRefTmpNorDns (0x6834), and the expansion factor dnsTmpCoeff (0x6836) is used. Density is calculated by the following formula: $DenComp = \frac{VolFlwNorDens}{(1 + dnsTmpCoeff(AdcTubeMeanTemp - dnsRefTmpNorDns))}$ in which °C representation of temperature is used. 4: A density sensor is attached to the 4-20mA Input. In this case the registers AdcRawMin (0x6600), AdcRawMax (0x6602), AdcFilNoSamples (0x6608), AdcCalOffset (0x6618), AdcCalGain (0x6620), DnsValMin (0x6622), and DnsValMax (0x6624) in the “Pressure” register group are used for the density measurement and must be set accordingly. A DnsConfig (0x6800) value of 4 takes precedence over a PressureCalcConfig (0x6610) value of 2 to 4 or 6 to 7.</p>

Address	Abbreviation	Type	Full Name / Description
0x6802	DnsChangeRel	FLOAT32	Density Change Relative: Maximum change in density from one reading to the next (1 reading = flow sensor frequency/4 cycles) that produces a warning and sets bit 30 of the Warnings (0x401E) input register. The default value is set to 1000kg/m ³ . This value is based on the unit specified in the DensityUnit holding register (0x6108).
0x6804	DenUpFctSL	FLOAT32	Density Upper Functional Safety Limit: The upmost limit for compensated density in the range of 0 to 12000kg/m ³ . When this limit is exceeded a warning is indicated –bit 7 in the SoftError (0x401C) input register is set. The default value is set to 12000kg/m ³ . This value is based on the unit specified in the DensityUnit holding register (0x6108).
0x6806	DenLwFctSL	FLOAT32	Density Lower Functional Safety Limit: The lower limit for compensated density in the range of 0 to 12000kg/m ³ . When this limit is exceeded a warning is indicated –bit 7 in the SoftError (0x401C) input register is set. The default value is set to 0kg/m ³ . This value is based on the unit specified in the DensityUnit holding register (0x6108).
0x6808	DenOpRng1FiThr	UINT32	Density Operating Warning Range Fault Integrator Threshold: Number of consecutive cycles (1 cycle = 10ms) the limits defined in Density Upper Functional Safety Limit or by Density Lower Functional Safety Limit must be violated before the warning is indicated – see bits 0 and 16 in the Warnings (0x401E) input register. The default value is 3 cycles.
0x680A	DenOpRng2FiThr	UINT32	Density Operating Safety Range Fault Integrator Threshold: Number of consecutive cycles (1 cycle = flow sensor frequency/4) the limits defined in Density Upper Functional Safety Limit or Density Lower Functional Safety Limit must be violated before the warning is issued –bit 7 in the SoftError (0x401C) input register is set. The default value is 3 cycles.
0x680C	DenChngFiThr	UINT32	Density Fault Integrator Threshold: Number of consecutive cycles (1 cycle = flow sensor frequency/4) the limit defined in Density Change Relative must be violated before the warning is issued –bit 30 of the Warnings (0x401E) input register is set. The default value is 3 cycles.
0x680E	DnsTubeRefTemp	FLOAT32	Density Tube Reference Temperature (for T1): Reference temperature for the tube temperature sensor for the density calculation. Default is 20 degrees Celsius. This value is based on the unit specified in the TemperatureUnit holding register (0x6100).
0x6810	DnsTorBarRefTemp	FLOAT32	Density Torsion Bar Reference Temperature (for T2): Reference temperature for the torsion bar temperature sensor for the density calculation. Default is 20 degrees Celsius. This value is based on the unit specified in the TemperatureUnit holding register (0x6100).
0x6812	u00	FLOAT32	Temperature compensation factor u00: u-factor constant of Quick Tcor Compensation.
0x6814 [d06]	u10	FLOAT32	Temperature compensation factor u10: u-factor constant of Quick Tcor Compensation.

Address	Abbreviation	Type	Full Name / Description
0x6816 [d07]	u01	FLOAT32	Temperature compensation factor u01: u-factor constant of Quick Tcor Compensation.
0x6818	u11	FLOAT32	Temperature compensation factor u11: u-factor constant of Quick Tcor Compensation.
0x681A	u20	FLOAT32	Temperature compensation factor u20: u-factor constant of Quick Tcor Compensation.
0x681C	u02	FLOAT32	Temperature compensation factor u02: u-factor constant of Quick Tcor Compensation.
0x681E	u21	FLOAT32	Temperature compensation factor u21: u-factor constant of Quick Tcor Compensation.
0x6820	u12	FLOAT32	Temperature compensation factor u12: u-factor constant of Quick Tcor Compensation.
0x6822	u30	FLOAT32	Temperature compensation factor u30: u-factor constant of Quick Tcor Compensation.
0x6824	u03	FLOAT32	Temperature compensation factor u03: u-factor constant of Quick Tcor Compensation.
0x6826 [d08]	dnsLowDensityCalPoint	FLOAT32	Density Low Density Calibration Point: Low Density Calibration Point value. Default is 0.0 kg/m ³ . This value is based on the unit specified in the DensityUnit holding register (0x6108).
0x6828 [d09]	dnsLowDensityFrequency	FLOAT32	Density Low Frequency Calibration Point: Flow sensor frequency at the Low Density Calibration Point (dnsLowDensityCalPoint) in Hertz. Default is 0.0 Hz.
0x682A [d10]	dnsHighDensityCalPoint	FLOAT32	Density High Density Calibration Point: High Density Calibration Point value. Default is 0.0 kg/m ³ . This value is based on the unit specified in the DensityUnit holding register (0x6108).
0x682C [d11]	dnsHighDensityFrequency	FLOAT32	Density High Frequency Calibration Point: Flow sensor frequency at the High Density Calibration Point (dnsHighDensityCalPoint) in Hertz. Default is 0.0 Hz.
0x684A [d12]	DnsKFactor	FLOAT32	(Since V1.80) Density Simple Calibration K-Factor: Gain of the simple density calibration feature. This will be calculated from the standard calibration data set when the data set the simple density calibration feature does not contain valid data. Setting this register to 0 causes the density calculation to revert to the two-point calibration parameters stored in the registers 0x6826 to 0x682C. This also causes the other parameters of the simple density calibration in the range of 0x684C to 0x6852 to be automatically updated with meaningful values.

Address	Abbreviation	Type	Full Name / Description
0x684C [d13]	DnsOffset	FLOAT32	(Since V1.80) Density Simple Calibration Offset: Offset of the simple density calibration feature. This usually is set to the density of the air and will be set to dnsLowDensityCalPoint (0x6826) when the data set for the simple density calibration feature does not contain valid data, more exactly when DnsKFactor is 0. This value is based on the unit specified in the DensityUnit holding register (0x6108).
0x684E	DnsFrequency	FLOAT32	(Since V1.80) Density Simple Calibration Frequency: Reference Frequency of the simple density calibration feature. This usually is set to the RHM frequency when the RHM sensor is filled with the air and will be set to dnsLowDensityFrequency (0x6828) when the data set for the simple density calibration feature does not contain valid data, more exactly when DnsKFactor is 0.
0x6850	DnsTubeRefTempSimple	FLOAT32	(Since V1.80) Density Simple Calibration Tube Reference Temperature: Tube temperature when the reference frequency is determined. This will be set to DnsTubeRefTemp (0x680E) when the data set for the simple density calibration feature does not contain valid data, more exactly when DnsKFactor is 0. This value is based on the unit specified in the TemperatureUnit holding register (0x6100).
0x6852	DnsTorRefTempSimple	FLOAT32	(Since V1.80) Density Simple Calibration Torsion Reference Temperature: Torsion temperature when the reference frequency is determined. This will be set to DnsTorBarRefTemp (0x6810) when the data set for the simple density calibration feature does not contain valid data, more exactly when DnsKFactor is 0. This value is based on the unit specified in the TemperatureUnit holding register (0x6100).
0x6854	DnsMassFlowSupervision	UINT32	(Since V1.82) Density Supervision of the Mass Flow: When set to 1 and AssurancePresent (0x6090) is not 0 an exceedance of the limits defined in DenUpFctSL (0x6804) and DenLwFctSL will result in a stop of the calculated mass flow after the time span specified in MassFlowHoldTime (0x6420) has passed. The default 0 disables this feature.

D.3.2 Density Calculation – MODBUS Input Registers

D.3.2.1 Density Calculation – MODBUS Input Registers, USER Level

Address	Abbreviation	Type	Full Name / Description
0x4800	DenFreqTempComp	FLOAT32	Temperature Compensated Frequency: Currently not used. Reserved for future use.
0x4802	DenFreqPrsComp	FLOAT32	Pressure Compensated Frequency for Density calculation: Currently not used. Reserved for future use.

Address	Abbreviation	Type	Full Name / Description
0x4804	TempCoeffDensity	FLOAT32	Density Temperature Correction Factor: Current density temperature correction factor value. Value depends upon the temperature correction for Density calculation and the Tube and Torsion Bar temperatures.
0x4806	DenComp	FLOAT32	Compensated Density: Current compensated density value. This value is based on the unit specified in DensityUnit holding register (0x6108). The standard/default unit is kg/m ³ .
0x4808	MassFlowDensCorrFactor	FLOAT32	Current Density Correction for Mass Flow: Contains the density dependent corrector factor for Mass Flow. Will be a constant 1.0 when the density correction is disabled, see MassFlowDensCorr (0x693C).
0x480A	StdDensity	FLOAT32	API MPMS Standard Density / Main Substance Density: The value in this register is used to calculate the volume flow out of the mass flow and thus also effects the volume totals. When the no special density calculation mode is not active, see DenCalcMode (0x683A), this register contains the same value as DenComp (0x4806). A special density calculation mode only is activated when DenCalcMode (0x683A) is not zero, APIDnsPresent [0x6092] is not zero, and the density is calculated from the sensor data (1 in DnsConfig, 0x6800). When in this case DenCalcMode (0x683A) contains one of the values 1, 2, or 3 this register contains the standard density in accordance with the API MPMS specification for the specified substance type. Consequently the volume flow and the volume total are based on the standard density. When DenCalcMode (0x683A) contains one of the values 4 or 5 this register contains the density found in DenMainSubstance (0x683C). Aside from this density the calculated volume flow and volume total is also affected by the cut of the main substance, see VolPercentMainSubstance and CutMainMass below. The value in this register is converted from (write) or to (read) the unit specified in DensityUnit holding register (0x6108). The standard unit is kg/m ³ . This value may be invalid when bit 27 in the Warnings register (0x401E) is set. See also the description of register DenCalcMode (0x683A).
0x480C	VolPercentMainSubstance	FLOAT32	Percentage of Main Substance in Volume: Contains the percentage amount of the main substance within the total volume when DenCalcMode is set to 4 or 5. Will be 100% otherwise. This value may be invalid when bit 27 in the Warnings register (0x401E) is set. See also the description of register DenCalcMode (0x683A).
0x480E	CutMainMass	FLOAT32	Cut of Main Substance in Mass: Contains the cut of the main substance in the measure mass flow in the range of 0.0 to 1.0 when DenCalcMode is set to 4 or 5. Will be 1.0 otherwise. This value may be invalid when bit 27 in the Warnings register (0x401E) is set. See also the description of register DenCalcMode (0x683A).
0x4810	RohT1	FLOAT32	Density for Special Function 1 at T1: See extra document 8.2.1.11.

Address	Abbreviation	Type	Full Name / Description
0x4812	RohT2	FLOAT32	Density for Special Function 1 at T2: See extra document 8.2.1.11.

D.4 Amplitude Diagnostic

In order to guarantee proper measurement results, the Rheonik flow sensor must oscillate within a defined amplitude range. The amplitude of the oscillation is controlled by a software feedback loop (PID). MODBUS holding registers are used to configure the feedback loop and the monitoring of the oscillation amplitude. MODBUS input registers contain the current excitation level of the loop-back circuitry, drive output power to the flow sensor, and additional diagnostic information. The values in these input registers also infer the level of damping applied to the drive by the process. These values are mainly used for diagnostic purposes.

D.4.1 Amplitude Diagnostic – MODBUS Holding Registers

D.4.1.1 Amplitude Diagnostic – MODBUS Holding Registers, SERVICE Level

Address/ID	Abbreviation	Type	Full name / Description
0x6400 [a01]	OutputStageMaxOpRange	INT32	Output Stage Maximum Operational Range: Maximum output amplitude in the range of -1 to 4095 to which the flow sensor may be excited (see AnFilAmplIOS, 0x4402). When this limit is exceeded a warning is indicated –bit 17 in the SoftError (0x401C) input register is set.
0x6402 [a02]	OutputStageMinOpRange	INT32	Output Stage Minimum Operational Range: Minimum output amplitude in the range of -1 to 4095 to which the flow sensor may be excited (see AnFilAmplIOS 0x4402). When this limit is exceeded a warning is indicated –bit 17 in the SoftError (0x401C) input register is set.
0x6404 [a03]	OutputStageFiThr	UINT32	Output Stage Fault Integrator Threshold: Number of cycles (1 cycle = 10ms) before output (or input) stage failure causes a warning in the Warnings or SoftError input register. The default value is 3 cycles.
0x6406 [a04]	OutputStageNoSamples	UINT32	Output Stage Number of Samples: Number of samples used to calculate the mean drive output level (AnFilAmplIOS, 0x4402). The default value is 4 samples.

Address/ID	Abbreviation	Type	Full name / Description
0x6408	OutputDriveDamping	UINT32	Output Drive Damping: This parameter sets the damping of the flow sensor excitation output (AnFilAmpIOS, 0x4402) in the range of 0 to 4095. The default is 0 which sets the excitation to a maximum. This value can be used to reduce the excitation level of the RHM sensor as it reduces the power of the drive output. This value is not used for the PID feedback control which is controlled by the parameter set in the address range 0x640A to 0x6412.
0x640A [a05]	OutputCtlTargetPickup	FLOAT32	Target Pickup Voltage: Specifies the target (peak) pickup voltage for the output drive control loop in mV units. The default is 80mV peak which corresponds to 160mv peak-peak. The range is from 40mV to 500mV.
0x640C [a06]	OutputCtlIntegralTarget	FLOAT32	Integral Control Range: Specifies the range in which the integral portion of the control loop is engaged in percent. The default is 30% which together with a Target Pickup Voltage of 120mV means that the integral control portion is engaged in the range of 92.3 to 156mV.
0x640E [a07]	OutputCtlPropFactor	FLOAT32	Proportional Factor of the Control Loop: Defines the factor which influences the proportional portion of the control loop in the range of 0 to 20. The default is 8.
0x6410 [a08]	OutputCtlIntFactor	FLOAT32	Integral Factor of the Control Loop: Defines the integration time of the integral portion of the control loop in the range of 0 to 20. The default is 2.0 and the unit is 1/s.
0x6412 [a09]	OutputCtlDiffFactor	FLOAT32	Differential Factor of the Control Loop: Defines the factor which influences the differential portion of the control loop in the range of 0 to 20. The default is 0 which effectively disables the differential control.
0x641E	PickupMinLevel	FLOAT32	(After 1.82) Minimum Pickup Level: Minimum pickup voltage level in percent of the target pickup level (OutputCtlTargetPickup, 0x640A) below the mass flow measurement is stopped because a multi-phase mode flow is assumed which greatly reduces the accuracy of the measurement. A value of 0.0 (default) disables this feature as does a value of 0 in APIDnsPresent (0x6092). When this feature is enabled and the pickup level drops below the specified level bit 25 in the SoftError Register is set. After this event the mass flow and the calculated density measurements are kept at the current level for the time span specified in MassFlowHoldTime (0x6420) before the mass flow set to 0.
0x6420	MassFlowHoldTime	UINT32	(After 1.82) Mass Flow Hold-Up Time: Time span in seconds after the beginning of one of the conditions described for PickupMinLevel (0x641E) or DnsMassFlowSupervision (0x6854) becomes true during which the mass flow and the density calculation is kept at the same level before the mass flow is set to 0. The default is 0. The maximum is 60s.

D.4.2 Amplitude Diagnostic – MODBUS Input Registers

D.4.2.1 Amplitude Diagnostic – MODBUS Input Registers, SERVICE Level

Address	Abbreviation	Type	Full name / Description
0x4400	AnOutputStage	UINT32	Measured Excitation of the Output Stage: Contains the current measurement of the flow sensor excitation at the drive coil of the RHM sensor. Range is from 0 to 4095.
0x4402	AnFilAmplIOS	UINT32	Drive Output Setting: Drive output setting for the flow sensor excitation in the range of 0 to 4095. This values is the result of a digital feedback loop and is an indication of the amount of power is used to excite the flow sensor.
0x4404	AnInputLeftCoil	UINT32	Left Pickup Coil Input Level: Voltage Level of the Left Pickup Coil in the range from 0 to 4095 (peak).
0x4406	AnInputRightCoil	UINT32	Right Pickup Coil Input Level: Voltage Level of the Right Pickup Coil in the range from 0 to 4095 (peak).
0x4408	OutputCtlVal	UINT32	Output of the Control Loop: Output value of the Drive Control Loop in the range of 0 to 4095.
0x440A	DriveCurrentRaw	UINT32	High Resolution Drive Current: Drive Current value in the range of 0 to 32767.
0x440C	DriveCurrentmA	FLOAT32	Drive Current mA: Drive Current value in mA.
0x440E	DriveGain	UINT32	Drive Gain: Drive Gain in %. This corresponds to OutputCtlVal (0x4408).
0x4410	DriveStability	FLOAT32	Stability of the Drive Control Output: Indicates the stability of the drive control output in %. The changes of the drive control output are filtered (with Tau=8s), recalculated as percentage of the current output value and then subtracted from 100. Thus, a stability indicator of 100% means that the drive control output did not change for a while.
0x4412	AmplStability	FLOAT32	Stability of the Input Amplitudes: Indicates the stability of the amplitude input in %. The target is the OutputCtlTargetPickup (0x640A) voltage. When the input amplitudes remain at this value the stability is 100%. Any deviation is filtered (with Tau=8s), converted in a percentage and subtracted from 100 to yield AmplStability.

D.5 Frequency Measurement

Sensor Frequency is used as the basis for integrating Mass Flow to a totalized mass value and for supported sensor sizes, for determining the density of the fluid in the sensor. The majority of the MODBUS holding registers in this group are used to define error conditions related to the attached sensor

and belong to the SERVICE access level. At the service level, it is possible to define the number of measurement samples for frequency filter. This value should be set fairly high when internal density measurement is used in order to suppress variances due to externally induced noise. This does, however, slow down response of the measured density value to sudden density changes.

The MODBUS input registers contain diagnostic information about the flow sensor frequency and period values.

D.5.1 Frequency Measurement – MODBUS Holding Registers

D.5.1.1 Frequency Measurement – MODBUS Holding Registers, SERVICE Level

Address/ID	Abbreviation	Type	Full name / Description
0x6200 [f01]	FreqOpRngMin	UINT32	Frequency Operating Range Period Minimum: Minimum value of the frequency of the flow sensor specified in 8ns units in the range of 125000 (1000Hz) to 2500000 (50Hz). When this limit is exceeded bits 12 and 13 of the SoftError (0x401C) input register are set. This value is not unit converted. Default is 312500 (400Hz).
0x6202 [f02]	FreqOpRngMax	UINT32	Frequency Operating Range Period Maximum: Maximum value of the frequency of the flow sensor specified in 8ns units in the range of 312500 (400Hz) to 2500000 (50Hz). When this limit is exceeded bits 12 and 13 of the SoftError (0x401C) input register are set. This value is not unit converted. Default is 2500000 (50Hz).
0x6204 [f03]	FreqBwRel	UINT32	Frequency Bandwidth Relative: Limit of the frequency noise specified in 8 period time units. When the differences of the currently measured period and the filtered period exceed this limit a warning is issued, see bits 12 and 13 of the SoftError (0x401C) input register. This indicates that the frequency is not stable. Default is 100000 (0.8ms or 1250Hz).
0x6206 [f04]	SicErrThr	UINT32	Signal Integrity Check Error Threshold: Number of consecutive times an error is detected in the period measurement before a warning is issued. Range is 1 to 100, default is 10. This is a counter based on a sensor frequency/4 sampling rate.
0x6208 [f05]	FreqFilNoSamples	UINT32	Frequency Filter Number of Samples: Number of samples for the frequency filter in the range of 1 to 200. Default is 80. This filter is based on a sensor frequency/4 sampling rate and determines the register value PeriodFiltered (0x4202) using the measure period PeriodRaw (0x4200).
0x620A	FreqFilNoiseLimit	UINT32	Frequency Filter Noise Limit: Currently unused noise band limit for smart filtering of the period/frequency measurement. If the period change from one reading to the next exceeds this value, the smart filter will raise the damping factor. The value is specified in 8ns units and ranges from 0 to 100000 (0.8ms). Default is 5000 (40us).

D.5.2 Frequency Measurement – MODBUS Input Registers

D.5.2.1 Frequency Measurement – MODBUS Input Registers, USER Level

Address	Abbreviation	Type	Full name / Description
0x4204	PeriodStability	UINT32	Sensor Frequency Stability Indicator: Current (absolute) difference between the PeriodRaw and PeriodFiltered values in 8ns units as an indicator of the stability of the sensor operation.
0x4206	SensorFrequency	FLOAT32	Filtered Sensor Frequency: Filtered sensor frequency in Hz unit.
0x4208	SensorPeriod	FLOAT32	Filtered Sensor Period: Filtered sensor period in seconds.
0x420A	FrequencyStability	FLOAT32	Frequency Stability Indicator: (Indicates the stability of the sensor oscillation frequency in percent. The period deviation in PeriodStability is calculated into a percentage based on the frequency range defined by RHM sensor density calibration in the registers dnsLowDensityFrequency (0x6828) and dnsHighDensityFrequency (0x682C). This number is then subtracted from 100. A value of 100% denotes a perfect stable sensor. A value of 0% may be caused by a quick filling of an empty RHM sensor with water which will cause the sensor frequency to change through the range defined in the density calibration information. During normal operations a value of 99.7% or better can be expected. Significant and longer lasting deviations may be caused by vibrations induced into the RHM sensor.

D.5.2.2 Frequency Measurement – MODBUS Input Registers, SERVICE Level

Address	Abbreviation	Type	Full name / Description
0x4200	PeriodRaw	UINT32	Measured Sensor Period: Current sensor period in 8ns units, mean value over the last 4 periods.
0x4202	PeriodFiltered	UINT32	Filtered Sensor Period: Filtered sensor period in 8ns units. The size of the filter is determined by FreqFilNoSamples (0x6208).

D.6 Phase Measurement

The change in pickup phase caused by a mass moving through the Rheonik flow sensor is used for the basis of the Mass Flow measurement. The resulting phase value is a primary input into the Mass Flow calculation controlled by the Mass Flow MODBUS holding register group described earlier.

The Phase Measurement MODBUS holding register group is used to control the flow direction and to configure filtering at the SERVICE access level. The MODBUS input registers contain the measured raw and filtered phase values plus other items used for diagnostic purposes.

When configuring the filter size (PhsFilNoSamples, 0x630A) the setting of the cut-off limit (MassFlowCutOffLimit, 0x6924) in the Mass Flow register group may also be considered. When the filter size is increased, the meter response to sudden changes in mass flow is slowed but this also means that the mass flow cut-off limit may be decreased for improved low flow measurement performance. Any decrease of the filter size in order to improve response time to mass flow changes should be accompanied with testing and possible adjustment of the mass flow cut-off limit to ascertain that no mass flow is indicated at zero due to noise in the phase measurement.

D.6.1 Phase Measurement – MODBUS Holding Registers

D.6.1.1 Phase Measurement – MODBUS Holding Registers, USER Level

Address/ID	Abbreviation	Type	Full name / Description
0x630A [n06] [N01]	PhsFilNoSamples	UINT32	Phase Filter Number of Samples: Number of samples for the phase filter which determines PhaseFilteredInterim (0x4306) out of PhaseRawZero (0x4302). The filter is based on a sensor frequency/4 sampling rate. Reducing this value will shorten the integration time. The range is from 1 to 200 (100 until Firmware V1.2.4) and the default value is 5.
0x6366 [N02]	FlowFilterDisplayTau	FLOAT32	(Since release 1.76) Filter Time Constant for Displayed Flows: Filter Time Constant for the optional additional flow filter used for displayed flows. This filter affects both the displayed mass and the displayed volume flow. The unit of this value is seconds. The range is from 0.0 to 60 seconds. The value 0.0 switches off this additional filter. This also is the default value. The filtered flows can be monitored in MassFlowRateDisplay (0x4906) and VolFlowRateDisplay (0x4A04).
0x6368 [N03]	FlowFilterFreqTau	FLOAT32	(Since release 1.76) Filter Time Constant for Flows of Frequency Outputs: Filter Time Constant for the optional additional flow filter used for flows converted to frequency outputs. This filter affects both the mass and the volume flows used as inputs to the frequency outputs. The unit of this value is seconds. The range is from 0.0 to 60 seconds. The value 0.0 switches off this additional filter. This also is the default value. The filtered flows can be monitored in MassFlowRateFreq (0x4906) and VolFlowRateFreq (0x4A04).
0x636A [N04]	FlowFilterModbusTau	FLOAT32	(Since release 1.76) Filter Time Constant for Filtered Modbus Flows: Filter Time Constant for the optional additional flow filter used for Modbus related control loops. This filter affects both the mass and the volume flows. The unit of this value is seconds. The range is from 0.0 to 60 seconds. The value 0.0 switches off this additional filter. This also is the default value. The filtered flows can be read from MassFlowRateModbus (0x4908) and VolFlowRateModbus (0x4A06) to be used in dedicated control loops for which the input has to be additionally filtered.

D.6.1.2 Phase Measurement – MODBUS Holding Registers, SERVICE Level

Address/ID	Abbreviation	Type	Full name / Description
0x6300 [n01]	PhsOpRngMin	INT32	Phase Operating Range Minimum: Minimum phase change of the flow sensor specified in 8ns units in the range of -5208333 to 0. Default value is -1250000. These values anticipate the expected max phase change per sensor to be about 20 degrees.
0x6302 [n02]	PhsOpRngMax	INT32	Phase Operating Range Maximum: Maximum phase change of the flow sensor specified in 8ns units in the range of 0 to 5208333. Default value is 1250000. These values anticipate the expected max phase change per sensor to be about 20 degrees.
0x6304 [n03]	PhsBwRel	INT32	Phase Bandwidth Relative: Maximum difference of the filtered to the measured phase (PhaseRawZero (0x4302) to PhaseFilteredInterim (0x4306)) specified in 8ns units. Range is 0 to 100000 (0.8ms), default value is 100000. A warning is indicated if phase measurement change exceeds this value indicating that the phase measurement is not stable. See bits 12 and 14 in the SoftError (0x401C) input register.
0x6306 [n04]	SicErrThrPhs	UINT32	Signal Integrity Check Error Threshold Phase: Number of consecutive times an error is detected in the phase measurement before a warning is indicated. Range is 1 to 100. Default is 10.
0x6308 [n05]	PhsFlwDirConfig	UINT32	Phase Flow Direction Configuration: Configuration of the flow direction to suit physical/mechanical installation: 0: Inverse. 1: Normal. Default value is 1 (normal).
0x630C	PhsFilNoiseLimit	UINT32	Phase Filter Noise Limit: Currently unused noise band limit for smart filtering the phase measurement. If the phase change from one reading to the next exceeds this value, the smart filter will raise the damping factor. The value is specified in mass flow units and value is converted from (write) or to (read) the unit specified in MassFlowUnit holding register (0x6106). Default is 5 kg/min.
0x630E	TotMassFilNoSamples	UINT32	Total Mass Filter Number of Samples: Currently unused number of samples used for the phase average for the total mass measurement (yields PhaseFilteredTotal (0x430C)). Values range from 1 to 100. Default is 1.
0x6310	PhsControl	UINT32	Phase Measurement Control: Bit field for the control of special phase measurement features: Bit 0=0: Allow a recovery from a prolonged sensor timeout probably caused by a multi-phase flow. Bit 0=1: Latch sensor signal timeout after 100s. Raises Bit 6 in ErrorStatus (0x401A) permanently.

D.6.2 Phase Measurement – MODBUS Input Registers

D.6.2.1 Phase Measurement – MODBUS Input Registers, USER Level

Address	Abbreviation	Type	Full name / Description
0x4306	PhaseFiltered	FLOAT32	Filtered Sensor Phase: The PhaseFilteredInterim value corrected by flow direction setting, see PhsFlwDirConfig (0x6308).
0x4308	PhaseFilteredInterim	FLOAT32	Filtered Sensor Phase Before Cutoff: Filtered sensor phase in 8ns units. Input of the filter is the PhaseRawZero (0x4302) value. The sample size of the filter is determined by PhsFilNoSamples (0x630A).
0x430A	Shutoffs	FLOAT32	Mass Flow Cutoff limit in 8ns units: Duplicate of the Mass Flow Cutoff limit in 8ns units, see MassFlowCutOffLimit (0x6924).
0x430C	PhsTcorZeroOffset	FLOAT32	Temperature compensated Zero Offset: Temperature compensated Zero Offset for especially calibrated sensors in 8ns units.
0x430E	PhaseFilteredTotal	FLOAT32	Filtered Sensor Phase After Cutoff: Filtered sensor phase (PhaseFiltered, 0x4304) in 8ns units after PhsCutOff cutoff evaluation. This value is used for the Mass Flow totalizer.

D.6.2.2 Phase Measurement – MODBUS Input Registers, SERVICE Level

Address	Abbreviation	Type	Full name / Description
0x4300	PhaseRaw	FLOAT32	Measured Sensor Phase: Current sensor phase in 8ns units, mean value over the last 4 periods.
0x4302	PhaseRawTcor	FLOAT32	Temperature corrected Sensor Period: Current sensor phase in 8ns units from which the phase determined by the Temperature Zero Offset is subtracted, mean value over the last 4 periods.
0x4304	PhaseRawZero	FLOAT32	Corrected Sensor Period: Current sensor phase (PhaseRawTcor) in 8ns units from which the phase determined by the Temperature Zero Offset is subtracted, mean value over the last 4 periods.
0x4310	PhaseIntrCount	UINT32	Sensor Phase Counter Mass Flow: Diagnostic counter which contains the total number of phase measurements. This counter is cleared when the totalizer is reset.
0x4312	PhaseIntrCountCutOff	UINT32	Sensor Phase Counter Cutoff: Diagnostic counter which contains the number of phase measurements not resulting in a cutoff condition. This counter is cleared when the totalizer is reset.

D.7 Temperature Measurement

The temperature of the Tube and the Torsion Bar elements of newer Rheonik flow sensor models are measured as inputs for the temperature correction calculation in the Mass Flow and the Density Measurement Calculations. In older sensor models, only the tube temperature is measured.

The MODBUS holding registers of this group are used to configure the type and the behavior of the temperature measurement on the SERVICE access level. Aside from diagnostic information, the MODBUS input registers contain the measured temperature values of the Tube and Torsion Bar as well as the internal temperature of the RHE20 electronics.

D.7.1 Temperature Measurement – MODBUS Holding Registers

D.7.1.1 Temperature Measurement – MODBUS Holding Registers, SERVICE Level

Address/ID	Abbreviation	Type	Full name / Description
0x6500 [x01]	TempConfig	UINT32	Temperature Configuration: Temperature Configuration setting: 0: Off – no temperature sensors used. 1: Tube Temperature sensor enabled (sensor is Pt100). 2: Torsion Bar temperature sensor enabled (sensor is Pt100). 3: Both tube and torsion bar temperature measurements enabled (sensors are Pt100). 4: Off – no temperature sensors used. 5: Tube Temperature sensor enabled (sensor is Pt1000). 6: Torsion Bar temperature sensor enabled (sensor is Pt1000). 7: Both tube and torsion bar temperature measurements enabled (sensors are Pt1000).
0x6502 [x02]	AdcTubeChange	FLOAT32	ADC Tube Change: Maximum allowed temperature change between two readings of the sensor tube temperature in degrees Celsius. Range is 1 to 100. Default value is 1 degree Celsius. When this limit is exceeded, bit 3 is set in the SoftError (0x401C) holding register as a warning indication. No unit conversion is carried out when accessing this register.
0x6504 [x03]	AdcTorBarChange	FLOAT32	ADC Torsion Bar Change: Maximum allowed temperature change between two readings of the torsion bar temperature in degrees Celsius. Range is 1 to 100. Default value is 1 degree Celsius. When this limit is exceeded bit 4 is set in the SoftError (0x401C) holding register as a warning indication. No unit conversion is carried out when accessing this register.
0x6506 [x04]	AdcTubeOpRngFiThr	UINT32	ADC Tube Operating Range Fault Integrator Threshold: Number of consecutive readings the tube temperature change failure condition must be true before indicating a warning with bit 3 of SoftError (0x401C). Range is from 1 to 100. Default value is 3.

Address/ID	Abbreviation	Type	Full name / Description
0x6508 [x05]	AdcTorBarOpRngFiThr	UINT32	ADC Torsion Bar Operating Range Fault Integrator Threshold: Number of consecutive readings the torsion bar temperature change failure condition must be true before indicating a warning with bit 4 of SoftError (0x401C). Range is from 1 to 100. Default value is 3.
0x650A [x06]	AdcTubeDegCelMin	FLOAT32	ADC Tube Degree Celsius Minimum: Minimum tube temperature in the range of -250 to -20 degree Celsius. When measured value is below this limit, a warning is indicated by setting bit 3 of SoftError (0x401C). Default value is -250 degrees Celsius. This value is based on the unit specified in TemperatureUnit holding register (0x6100).
0x650C [x07]	AdcTubeDegCelMax	FLOAT32	ADC Tube Degree Celsius Maximum: Maximum tube temperature in the range of 60 to 400 degree Celsius. When this value is exceeded a warning is indicated by setting bit 3 of SoftError (0x401C). Default value is 400 degrees Celsius. This value is based on the unit specified in TemperatureUnit holding register (0x6100).
0x650E [x08]	AdcTorBarDegCelMin	FLOAT32	ADC Torsion Bar Degree Celsius Minimum: Minimum torsion bar temperature in the range of -250 to -20 degree Celsius. When the measured value is below this limit, a warning is indicated by setting bit 3 of SoftError (0x401C). Default value is -250 degrees Celsius. This value is based on the unit specified in TemperatureUnit holding register (0x6100).
0x6510 [x09]	AdcTorBarDegCelMax	FLOAT32	ADC Torsion Bar Degree Celsius Maximum: Maximum torsion bar temperature in the range of 60 to 400 degree Celsius. When this value is exceeded, a warning is indicated by setting bit 3 of SoftError (0x401C). Default value is 400 degrees Celsius. This value is based on the unit specified in TemperatureUnit holding register (0x6100).
0x6512 [x10]	AdcTubeOffset	FLOAT32	ADC Tube Offset: Tube temperature calibration offset. This value is added to the measured Tube temperature as a correction factor. Range is from -20 to +20 degree Celsius. Default value is 0.0. The value is not converted to the unit specified in TemperatureUnit holding register when transferred via Modbus.
0x6514 [x11]	AdcTorBarOffset	FLOAT32	ADC Torsion Bar Offset: Torsion bar temperature calibration offset. This value is added to the measured Tube temperature as a correction factor. Range is from -20 to +20 degree Celsius. Default value is 0.0. The value is not converted to the unit specified in TemperatureUnit holding register when transferred via Modbus.
0x6516 [x12]	AdcTubeFilNoSamples	UINT32	ADC Tube Filter Number of Samples: Number of samples for the tube temperature filter to yield AdcTubeMeanTemp (0x4500) out of AdcTubeTempRaw (0x4508) in the range of 1 to 256. Default value is 100.
0x6518 [x13]	AdcTorBarFilNoSamples	UINT32	ADC Torsion Bar Filter Number of Samples: Number of samples for the torsion bar temperature filter to yield AdcTorBarMeanTemp (0x4502) out of AdcTorBarTempRaw (0x450A) in the range of 1 to 256. Default value is 100.

Address/ID	Abbreviation	Type	Full name / Description
0x651A [x14]	AdcTubeCalOffset	FLOAT32	ADC Tube Calibration Offset: Tube low temperature calibration point for Pt100 sensors at 60 Ohms or for Pt1000 sensors at 600 Ohms (-100.64 °C according to the standard). Default value is -100.64. The value is not converted to the unit specified in TemperatureUnit holding register when transferred via Modbus.
0x651C [x15]	AdcTubeCalGain	FLOAT32	ADC Tube Calibration Gain: Tube high temperature calibration point for Pt100 sensors at 138.5 Ohms or for Pt1000 sensors at 1385 Ohms (100.0 °C according to the standard). Default value is 100.0 for firmware version 1.2.7 upwards, 107.0 for lower firmware versions. The value is not converted to the unit specified in TemperatureUnit holding register when transferred via Modbus.
0x651E [x16]	AdcTorBarCalOffset	FLOAT32	ADC Torsion Bar Calibration Offset: Torsion bar low temperature calibration point for Pt100 sensors at 60 Ohms or for Pt1000 sensors at 600 Ohms (-100.64 °C according to the standard). Default value is -100.64. The value is not converted to the unit specified in TemperatureUnit holding register when transferred via Modbus.
0x6520 [x17]	AdcTorBarCalGain	FLOAT32	ADC Torsion Bar Calibration Gain: Torsion bar high temperature calibration point for Pt100 sensors at 138.5 Ohms or for Pt1000 sensors at 1385 Ohms (100.0 °C according to the standard). Default value is 100.0 for firmware version 1.2.7 upwards, 107.0 for lower firmware versions. The value is not converted to the unit specified in TemperatureUnit holding register when transferred via Modbus.
0x6522 [x18]	TubeToTorsion	FLOAT32	Conversion from Tube to Torsion Temperature: Conversion when the torsion bar temperature is to be estimated out of the tube temperature because no torsion bar temperature is present. The unit is % and the default value is 90%.
0x6524	TempCableResistance	FLOAT32	Cable Resistance to Temperature Sensors: Cable resistance of a single wire used for the temperature sensors. When using standard Rheonik cables this is 56 Ohm/km or 0,056 Ohm/m (AWG22) which has to be multiplied with the length of the cable. The parameter is intended to be used as an alternative to the offset parameters AdcTubeOffset (0x6512) and AdcTorBarOffset (0x6514) which should be 0 if this parameter differs from 0. Default is 0.0 Ohm, maximum is 100 Ohm. For temperatures below -150°C it is advised to use this parameter to calibrate the temperature sensors and leave the temperature calibration registers 0x651A to 0x6520 as well as the offset registers 0x6512 and 0x6514 at their default values.

D.7.2 Temperature Measurement – MODBUS Input Registers

D.7.2.1 Temperature Measurement – MODBUS Input Registers, USER Level

Address	Abbreviation	Type	Full name / Description
0x4500	AdcTubeMeanTemp	FLOAT32	Mean Tube Temperature: Filtered and calibrated tube temperature. This value is used for temperature compensation calculations where the tube temperature is needed. This value is based on the unit specified in TemperatureUnit holding register (0x6100).
0x4502	AdcTorBarMeanTemp	FLOAT32	Mean Torsion Bar Temperature: Filtered and calibrated torsion bar temperature. This value is used for temperature compensation calculations where the torsion bar temperature is needed. This value is based on the unit specified in TemperatureUnit holding register (0x6100).
0x4504	OnBrdTemp	FLOAT32	Electronics Temperature: Internal temperature of the transmitter electronics. This value is based on the unit specified in TemperatureUnit holding register (0x6100).

D.7.2.2 Temperature Measurement – MODBUS Input Registers, SERVICE Level

Address	Abbreviation	Type	Full name / Description
0x4506	AdcTubeRaw	UINT32	Tube Temperature Raw in ADC Units: Current unfiltered tube temperature in ADC units for diagnostic purposes.
0x4508	AdcTubeTempRaw	FLOAT32	Tube Temperature Raw in degrees: Current unfiltered tube temperature. The temperature calibration is not yet applied. This value is based on the unit specified in TemperatureUnit holding register (0x6100).
0x450A	AdcTorBarRaw	UINT32	Torsion Bar Temperature Raw ADC units: Current unfiltered torsion bar temperature in ADC units for diagnostic purposes.
0x450C	AdcTorBarTempRaw	FLOAT32	Torsion Bar Temperature Raw in degrees: Current unfiltered torsion bar temperature. The temperature calibration is not yet applied. This value is based on the unit specified in TemperatureUnit holding register (0x6100).
0x450E	IDAC0AdcTubeMeanTemp	FLOAT32	Temperature Diagnostic Register 1: Currently not used.
0x4510	IDAC0TorBarMeanTemp	FLOAT32	Temperature Diagnostic Register 2: Currently not used.

D.8 Pressure Management

In order to improve the performance of some RHM sensors in the case of varying system pressures the RHE transmitter incorporates the possibility to add a pressure correction to the mass flow calculation. This either can be done statically by setting the parameter PrsExternalInitial (0x6612) to the system pressure used during normal operations or dynamically by additionally updating the PrsExternalCurrent (0x6620) register periodically via Modbus. Alternatively, the pressure value may be transferred via the Analog Input. The origin of the pressure data depends on the setting of the PressureCalcConfig (0x6610) register.

The pressure value in PrsCorrRef is subtracted from PrsExternalCurrent and then multiplied to MassFlowPressCorr (0x661E) to yield the variable part of a pressure correction factor MassFlowPressCorrFactor (0x4608). This factor is calculated to

$$\text{MassFlowPressCorrFactor} = 1.0 + \text{MassFlowPressCorr} * (\text{PrsExternalCurrent} - \text{PrsCorrRef})$$

and multiplied to the K-Factor in order to add a pressure correction to the mass flow calculation. When the MassFlowPressCorr (0x661E) is 0.0 the pressure correction feature is disabled.

The Analog Input also may be configured to support an external density or an external temperature as input to the API MPMS Density calculation.

D.8.1 Pressure – MODBUS Holding Registers

D.8.1.1 Pressure – MODBUS Holding Registers, USER Level

Address/ID	Abbreviation	Type	Full Name / Description
0x6600 [P02]	AdcRawMin	UINT32	Digital Operating Range ADC for Pressure Minimum: Digital Operating Range ADC for the current loop (Pressure or Density) minimum. This should correspond to a level above the fire low limit (about 3.8mA). An exceedance of this value causes a bit 11 of the SoftError (0x401C) register to be set. The allowable range corresponds to about 2.0 to 6.0mA converted into ADC units. Default is a value which corresponds to 3.8mA.
0x6602 [P03]	AdcRawMax	UINT32	Digital Operating Range ADC for Pressure Maximum: Digital Operating Range ADC for the current loop (Pressure or Density) maximum. This should correspond to a level above the fire high limit (about 20.4 mA). An exceedance of this value causes a bit 11 of the SoftError (0x401C) register to be set. The allowable range corresponds to about 15.0 to 25.0mA converted into ADC units. Default is a value which corresponds to 20.4mA.
0x6604 [P04]	PrsValMin	FLOAT32	Pressure Operating Range Minimum: Pressure Operating Range Minimum. This depends on the pressure sensor and defines the pressure value at a nominal 4mA current. This value based on the unit specified pressure unit conversion register (0x6102). Range is from -1100.0 to +5000000 hPa.

Address/ID	Abbreviation	Type	Full Name / Description
0x6606 [P05]	PrsValMax	FLOAT32	Digital Operating Range ADC for Pressure Maximum: Pressure Operating Range Maximum. This depends on the pressure sensor and defines the pressure value at a nominal 20mA current. This value is converted into the unit specified pressure unit conversion register (0x6102). Range is from 0.0 to +5000000 hPa.
0x6608 [P06]	AdcFilNoSamples	UINT32	Number of samples for Pressure input filter: Number of samples for current loop input (Pressure or Density) measurement filter in the range of 1 to 32.
0x660A [P07]	PrsChange	FLOAT32	Maximum Change of the Pressure: Defines the maximum allowed change of the pressure, i.e. the difference between actual and mean pressure. This value is converted into the unit specified pressure unit conversion register (0x6102). Range is from 0.1 to +5000000 hPa.
0x660C [P08]	PrsOpRngFiThr	UINT32	Pressure Operating Range Fault Integrator Threshold: Number of measurements (done every 500ms) after which an exceedance of the pressure operating range results in a set bit 11 in SoftError (0x401C). Default is 3. This limit is also when the warning range is exceeded before bit 11 is set in Warnings (0x401E).
0x660E [P09]	PrsOffset	FLOAT32	Pressure Offset Set By User: The defined Pressure Offset will be added to the measured pressure to yield PrsCurr (0x4604) and PrsMean (0x4606). This value is intended to be used to convert a relative pressure into absolute pressure. Default is 0.0. This value is converted into the unit specified pressure unit conversion register (0x6102). Range is from -1100.0 to +5000000 hPa.

Address/ID	Abbreviation	Type	Full Name / Description
0x6610 [P01]	PressureCalcConfig	UINT32	<p>Configuration of Pressure Calculation: This parameter controls the origin of the pressure and temperature data used for the API MPMS density calculation.</p> <p>For following values the temperature for the API MPMS calculation is taken from the tube temperature (AdcTubeMeanTemp [0x4500]):</p> <ul style="list-style-type: none"> 0: Pressure measurement and calculation is switched off. 1: Pressure is always taken from the PrsExternalCurrent register (0x6620) which may be updated any time by the user. Its initial value can be set during the installation of the system in PrsExternalInitial (0x6612). 2: An absolute pressure sensor is attached to the 4-20mA input. 3: A relative pressure sensor is attached to the 4-20mA input. <p>For the following value the temperature for the API MPMS calculation is taken from the analog input and the pressure is taken from the PrsExternalCurrent register (0x6620):</p> <ul style="list-style-type: none"> 4: A temperature sensor is attached to the 4-20mA input. <p>For following value the temperature for the API MPMS calculation is taken from ExtTemperatureCurr (0x6630) and the pressure is taken from the PrsExternalCurrent register (0x6620):</p> <ul style="list-style-type: none"> 5: External data is used for temperature and pressure. <p>For following value the temperature for the API MPMS calculation is taken from ExtTemperatureCurr (0x6630) and the pressure is taken from analog input:</p> <ul style="list-style-type: none"> 6: An absolute pressure sensor is attached to the 4-20mA input. 7: A relative pressure sensor is attached to the 4-20mA input. <p>Note, that a density sensor also may be attached to the 4-20mA input when DnsConfig (0x6800) is set to 4. In this case the registers AdcRawMin (0x6600), AdcRawMax (0x6602), AdcFilNoSamples (0x6608), AdcCalOffset (0x6618), AdcCalGain (0x6620), DnsValMin (0x6622), and DnsValMax (0x6624) are used for the density measurement and must be set accordingly. A DnsConfig (0x6800) value of 4 takes precedence over a PressureCalcConfig value of 2 to 4 and 6 to 7.</p>
0x6612 [P10]	PrsExternalInitial	FLOAT32	<p>Initial Pressure set by User: This initial pressure value is copied to the current pressure register PrsExternalCurrent (0x6620) which may be updated periodically by the user. This value is converted into the unit specified pressure unit conversion register (0x6102). Range is from 0.0 to 5000000 hPa.</p>
0x6614 [P11]	PrsWrnLvlMin	FLOAT32	<p>Pressure Warning Range Lower Limit: When the filtered pressure (0x4606) is found to be below the Pressure Warning Range Lower Limit bit 11 in the Warnings register (0x401E) is set. Range is from -1100.0 to +5000000 hPa.</p>

Address/ID	Abbreviation	Type	Full Name / Description
0x6616 [P12]	PrsWrnLvlMax	FLOAT32	Pressure Warning Range Upper Limit: When the filtered pressure (0x4606) is found to be above the Pressure Warning Range Lower Limit bit 11 in the Warnings register (0x401E) is set. Range is from -1100.0 to +5000000 hPa.
0x6618 [P13]	AdcCalOffset	UINT32	ADC Calibration Offset Setting: Calibration setting for the ADC offset. During the calibration of the 4-20mA interface this value should be taken from AdcPrsRaw (0x4600) when a 4mA current is applied to the interface. The allowable range corresponds to 2.0 to 6.0mA converted into ADC units.
0x661A [P14]	AdcCalGain	UINT32	ADC Calibration Gain Setting: Calibration setting for the ADC gain. During the calibration of the 4-20mA interface this value should be taken from AdcPrsRaw (0x4600) when a 20mA current is applied to the interface. The allowable range corresponds to about 16.0 to 24.0mA converted into ADC units.
0x661C [P15]	PrsCorrRef	FLOAT32	Reference Pressure for Mass Flow: Reference Pressure for the Mass Flow Correction. This value is converted into the unit specified pressure unit conversion register (0x6102). For a relative pressure sensor this value may be 0.0. For an absolute pressure sensor this may correspond to the ambient air pressure. Range is from -1100.0 to +5000000 hPa.
0x661E [P16]	MassFlowPressCorr	FLOAT32	Pressure Correction Factor: Pressure Correction factor for the Mass Flow calculation. This value is based on the Bar pressure unit (100000 Pa), i.e. its unit is 1/bar, and depends on the RHM sensor type. The default is 0.0 which disables the pressure correction feature. See also MassFlowPressCorrFactor (0x4608).
0x6620	PrsExternalCurrent	FLOAT32	Current Pressure set by User: Any update by the user to this register will have an immediate effect as this register is not part of the EEPROM based setup. This value in this registers initialized from the initial pressure register PrsExternalInitial (0x6612). PrsExternalCurrent may be updated periodically by the user in order to supply the transmitter with an up-to-date pressure value. This value is converted into the unit specified pressure unit conversion register (0x6102). Range is from 0.0 to 5000000 hPa. The user is responsible for the consistency of the data written to this register.
0x6622 [P17]	DnsValMin	FLOAT32	Density Operating Range Minimum: Density Operating Range Minimum used when DnsConfig (0x6800) is set to 4. This depends on the pressure sensor and defines the pressure value at a nominal 4mA current. This value is based on the unit specified density unit conversion register (0x6108). Range is from 0.0 to 12000 kg/m3.
0x6624 [P18]	DnsValMax	FLOAT32	Density Operating Range Maximum: Density Operating Range Maximum used when DnsConfig (0x6800) is set to 4. This depends on the density sensor and defines the density value at a nominal 20mA current. This value is based on the unit specified density unit conversion register (0x6108). Range is from 0.0 to 12000 kg/m3.

Address/ID	Abbreviation	Type	Full Name / Description
0x6626 [P19]	ExtTempValMin	FLOAT32	External Temperature Operating Range Minimum: (Since Release 2.06) Temperature Operating Range Minimum used when PressureCalcConfig (0x6610) is set to 4. This depends on the temperature sensor and defines the pressure value at a nominal 4mA current. This value is based on the unit specified by the temperature unit conversion register (0x6100). Range is from -270.0 to 420°C.
0x6628 [P20]	ExtTempValMax	FLOAT32	External Temperature Operating Range Maximum: (Since Release 2.06) Temperature Operating Range Maximum used when PressureCalcConfig (0x6610) is set to 4. This depends on the temperature sensor and defines the temperature value at a nominal 4mA current. This value is based on the unit specified by the temperature unit conversion register (0x6100). Range is from -270.0 to 420°C.
0x662A	ExtTemperatureCurr	FLOAT32	Current External Temperature: (Since Release 2.19): Current external temperature for the API MPMS density calculation when PressureCalcConfig (0x6610) is set to 5, 6, or 7. An update of this register has an immediate effect. This value is based on the unit specified by the temperature unit conversion register (0x6100). Range is from -270.0 to 420°C.

D.8.2 Pressure – MODBUS Input Registers

Pressure – MODBUS Input Registers, USER Level

Address	Abbreviation	Type	Full Name / Description
0x4600	AdcPrsRaw	UINT32	Raw Pressure Measurement: Current measurement value in ADC units.
0x4602	AdcPrsMean	UINT32	Mean Pressure Measurement: Filtered measurement value in ADC units.
0x4604	PrsCurr	FLOAT32	Current Pressure Measurement: Use PrsMean (0x4606) instead.
0x4606	PrsMean	FLOAT32	Mean Pressure Measurement: The current filtered pressure used by the RHE transmitter. For pressure modes 1, 4, and 5 (see PressureCalcConfig) this value reflects the pressure setting found in PrsExternalCurrent (0x6620). This value is converted into the unit specified pressure unit conversion register (0x6102)
0x4608	MassFlowPressCorrFactor	FLOAT32	Current Pressure Correction for Mass Flow: Indicates the current pressure correction factor for the mass flow calculation. This register will contain 1.0 when the pressure correction is not enabled.

Address	Abbreviation	Type	Full Name / Description
0x460A	ExtTemperature	FLOAT32	External Temperature: (Since Release 2.06) Current External Temperature at the 4-20mA input for API MPMS correction. This value is set to the tube temperature when PressureCalcConfig (0x6610) is set to 1, 2, or 3 and to ExtTemperatureCurr (0x662A) when PressureCalcConfig (0x6610) is set to 6 or 7. The unit of this register is defined by the temperature conversion register TemperatureUnit (0x6100).

D.9 Generic

The MODBUS holding registers in the Generic group contain information about the RHE transmitter device, the flow sensor, communication parameters, and the access level security scheme. The MODBUS input registers contain version identifications and status register values for error and warning indication.

D.9.1 Generic – MODBUS Holding Registers

D.9.1.1 Generic – MODBUS Holding Registers, USER Level

Address/ID	Abbreviation	Type	Full Name / Description
0x6000	ServicePassword	STRING4	Service Password: 4 hexadecimal character Service level password, not readable at the User configuration level. Decimal digits from '0' to '9' and hexadecimal digits from 'A' to 'F' or 'a' to 'f' are allowed. This password depends on the serial number of the RHE transmitter electronics.
0x6002	FactoryPassword	STRING4	Factory Password: 4 hexadecimal character Factory level password, not readable at the User configuration level. Decimal digits from '0' to '9' and hexadecimal digits from 'A' to 'F' or 'a' to 'f' are allowed. This password depends on the serial number of the RHE transmitter electronics.
0x6004 [H12]	UserPassword	STRING4	User Password: A four character value displayed as a decimal number. To determine the password value, determine the ASCII hexadecimal equivalent for each character. Enter the string into Hexadecimal to decimal converter to get the new value. The default value "1111" is equivalent to the hexadecimal number 0x31313131. A write to this field when logged in as SERVICE or FACTORY will change the user password.
0x6006	Parameter Commit	UINT32	Parameter Commit: Setting the contents of this holding register to 1 forces all modified setup parameters to be written to non-volatile memory. This operation should be followed by a write to the Reset Request holding register 0x6008 in order to activate the modified setup.

Address/ID	Abbreviation	Type	Full Name / Description
0x6008 [Q05]	Reset Request	UINT32	Reset Request: Setting the contents of this holding register to 1 causes the device to reset. Usually used after modifying and committing parameters to non-volatile memory.
0x600A	Reset Error Buffer	UINT32	Reset Error Buffer: Setting the contents of this holding register to 1 causes the system-internal failure counters to be reset. (FAM, NVRAM range from 0x13FE00 to 0x13FF00).
0x60A0 [Y01]	HARTPollingID	UINT32	HART Polling ID: HART Polling ID in the Range of 0 to 15. Note, that a polling id different from 0 does not automatically imply a disabled current loop (HART V7). Use HARTLoopState (0x60A2) to disable the current loop. Default is 0.
0x60A2 [Y02]	HARTLoopState	UINT32	HART Loop State: When set to 0 HARTLoopState disables the current loop and fixes it to 4mA. When set to 1 the loop is enabled and reflects the value of the assigned parameters.
0x60A4 [Y03]	HARTPreambles	UINT32	HART Preamble Count: HART Preamble characters to be used when a response telegram is transmitted in the Range of 5 to 15. Default is 5.

D.9.1.2 Generic – MODBUS Holding Registers, SERVICE Level

Address/ID	Abbreviation	Type	Full Name / Description
0x600E	Service Time	UINT32	Service Time: Power-on time of the RHE transmitter electronics in seconds since last service. Should be reset when the device is serviced.
0x6010 [g01]	Baud Rate	UINT32	Baud Rate: Baud Rate of the external RS485 serial line. The default is 57600. Supported values are 9600, 19200, 38400, and 57600. The baud rate of the Modbus master interface must match the value in this holding register. Note that the baud rate of the internal USB-attached serial interface is fixed at 57600.
0x6012 [g02]	Parity	UINT32	Parity: Parity bit configuration of the external RS485 serial line. The default is 2 (Even). Allowed values are 0 (None), 1 (Odd), and 2 (Even). The parity setting of the Modbus master interface must match the value in this holding register. A setting of 0 (None) forces a configuration of two stop bits- see holding register "Stop Bits" 0x6014 below. Note that the parity of the internal USB-attached serial interface is fixed at 2 (Even).

Address/ID	Abbreviation	Type	Full Name / Description
0x6014 [g03]	Stop Bits	UINT32	Stop Bits: Stop bit configuration of the external RS485 serial line. The default is 1 stop bit. Allowed values are 1 or 2 stop bits. The stop bit configuration of the Modbus master interface must match the value in this holding register. Note that the stop bits of the internal USB-attached serial interface is fixed at 1.
0x6016 [g04]	Slave Address	UINT32	Slave Address: This holding register specifies the Modbus slave address of the RHE device in the range of 1 to 247. Default is 1. When a Modbus master sends a message to the RHE devices this slave address must be used in the first byte of the Modbus message. Note that the Modbus slave address of the internal USB-attached serial interface is fixed at 1.
0x6018	Termination	UINT32	Termination: Reserved for future use.

0x601A [g05]	Sensor Type	UINT32	<p>Sensor Type: A numeric number that corresponds to the attached sensor type:</p> <ul style="list-style-type: none"> 0: Unknown 1: RHM015 2: RHM03 3: RHM04 4: RHM06 5: RHM08 6: RHM12 7: RHM15 8: RHM20 9: RHM30 10: RHM40 11: RHM60 12: RHM80 13: RHM100 14: RHM160 15: RHM015S 16: RHM02S 17: RHM03S 18: RHM04S 19: RHM06S 20: RHM10S 21: RHM15S 22: RHM20S <p>Currently the sensor type is not used in RHE transmitter-internal calculations, but it is useful for service purposes.</p>
0x6034	Assembly Sensor Serial	STRING32	<p>Assembly Sensor Serial: Serial number of the RHM sensor when sold as a paired unit/assembly.</p>
0x6044	Assembly Sensor Part Number + Revision	STRING16	<p>Assembly Sensor Part Number + Revision: Part number of the RHM sensor when sold as a paired unit/assembly.</p>
0x6096	SpecialFunction1	UINT32	<p>Special Function 1: Special Function 1 enabler. See extra document 8.2.1.11 or extra document 8.2.1.33.</p>

D.9.1.3 Generic – MODBUS Holding Registers, FACTORY Level

Address	Abbreviation	Type	Full Name / Description
0x600C	Total Run Time	UINT32	Total Run Time: Power-on time of the RHE transmitter electronics in seconds over lifetime.
0x601C	System Serial Number	STRING32	System Serial Number: Rheonik internal identification of a combined RHM/RHE serial number (“void” when not used).
0x602C	System Part Number + Revision	STRING16	System Part Number + Revision: Rheonik internal identification of a combined RHM/RHE part number (“void” when not used).
0x604C	Product Code	STRING64	Product Code: Rheonik internal identification of the RHE transmitter product code.
0x606C	Electronic Serial Number	STRING32	Electronic Serial Number: Serial number of the RHE transmitter electronics. This string influences Service and Factory passwords.
0x607C	Electronic Part Number + Revision	STRING16	Electronic Part Number + Revision: Rheonik internal identification of the RHE transmitter electronic.
0x6084	VolDensPresent	UINT32	Volume/Density Calculation Present: Volume and density calculation present in firmware (1=present, 0=not present).
0x6086	CurrOutPresent	UINT32	Current Output Present: 0: None present. 1: Main 4-20mA Channel present. 2: Secondary 4-20mA Channel present. 3: Main and Secondary 4-20mA Channels present.
0x6088	DigOutPresent	UINT32	Digital Output Present: Versatile Digital I/O present in hardware: Bit 0 set: Pulse Output 1 present (may be used as Status Output 1). Bit 1 set: Pulse Output 2 present (may be used as Status Output 2). Bit 2 set: Status Output 3 present. Bit 3 set: Status Output 4 present. Bit 4 set: Digital Input 1 present. Bit 5 set: Digital Input 2 present. When bits are cleared the respective interface is not present. A value of 63 (0x3F) means that all output and input interfaces are present.
0x608A	PressurePresent	UINT32	Pressure Interface Present: Signals the presence of a 4-20mA current input interface (1=present, 0=not present). Only when this interface is present a DnsConfig (0x6800) value of 4 or PressureCalcConfig values of 2 to 4 or 6 to 7 make sense.

Address	Abbreviation	Type	Full Name / Description
0x608C	HARTPresent	UINT32	Pressure Interface Present: When set to 1 indicates the presence of the HART chip and enables the HART protocol stack. The default is 0 which disables the HART protocol.
0x608E	RHEType	UINT32	RHE Type: Two-digit value specifying the RHE Type, e.g. 27 for RHE27.
0x6090	AssurancePresent	UINT32	Assurance Status Present: Assurance Status supervision present in firmware.
0x6092	APIDnsPresent	UINT32	API Density Calculation Present: API MPMS Density calculation present in firmware.
0x6094	RS485Present	UINT32	RS485 Interface Present: 0: RS485 interface not present in hardware. 1: RS485 interface present in hardware.

D.9.2 Generic – MODBUS Input Registers

D.9.2.1 Generic – MODBUS Input Registers, USER Level

Address	Abbreviation	Type	Full Name / Description
0x4000	NvmLayoutVersion	UINT32	Nvm Layout Version: Indication of the layout used to store the holding registers.
0x4002	CpldDrvPartNumber	STRING16	Part Number of the CPLD Firmware: Part Number of the CPLD Firmware.
0x400A	ApplicationSWVersion	STRING16	Application Software Version: Software Version of the RHE Measurement Software.
0x4012	BootLoaderSWVersion	STRING16	Bootloader Software Version: Software Version of the RHE Bootloader.

Address	Abbreviation	Type	Full Name / Description
0x401A	ErrorStatus	UINT32	<p>Error Status: This register is a bit set which contains the information about failures. Reset is by a power cycle only or a commanded system reset. The following bits are defined:</p> <ul style="list-style-type: none"> Bit 0: After system startup, inconsistencies in the parameter memory were detected. Parameters were reset to defaults. Reinstallation of system parameters is necessary. Bit 1: Configuration of the 4-20mA interface in error. Correct and restart the system. Bit 2: Configuration of the pulse output interface in error. Correct and restart the system. Bit 3: Temperature sensor ADC does not respond (possible hardware failure). Bit 4: No proper zeroing information found in flash memory. Repeat the Zeroing Process. Bit 5: No proper totalizer information found in flash memory. Reset the totalizer and restart the system. Bit 6: CPLD logic does not respond (possible hardware failure or CPLD programming error. Bit 7: CPU-internal NVM not accessible. Severe hardware failure. System restart is needed. Bit 8: CPU-internal NVM could not be initialized. Severe hardware failure. System restart is needed. Bit 9: Density configuration in error. Correct and restart the system. Bit 10: Configuration of the secondary 4-20mA interface in error. Correct and restart the system. Bit 11: Configuration of the 4-20mA Input (Pressure/Density) invalid. Bit 12: Automatic Batch Configuration invalid. Bit 13: Special Density Calculation configuration invalid. Bits 14 – 31: Reserved

Address	Abbreviation	Type	Full Name / Description
0x401C	SoftError	UINT32	<p>Soft Error Status: This register is a bit set which contains the information about errors which appear and clear depending on the operational environment. The following bits are defined:</p> <ul style="list-style-type: none"> Bit 0: Reserved. Bit 1: Current Output Readback Failed (hardware problem at the 4-20mA current output). Bit 2: Pulse Output Range Exceeded (possible configuration error). Bit 3: Tube Temperature Reading Error (possible hardware error). Bit 4: Torsion Bar Temperature Reading Error (possible hardware error). Bit 5: Electronics Temperature Reading Error (possible hardware error). Bit 6: ADS1248 failure (internal hardware error). Bit 7: Density limit exceeded (possible configuration error). Bit 8: Mass Flow limit exceeded (possible configuration error). Bit 9: Volume Flow limit exceeded (possible configuration error). Bit 10: Zeroing Process not successful (possible sensor instability). Bit 11: Pressure Input Exceedance (Firestate). Bit 12: Sensor signals in error (possible hardware error). Bit 13: Implausible sensor frequency detected by CPLD (possible hardware error). Bit 14: Implausible sensor phase detected by CPLD (possible hardware error). Bit 15: Density range exceeded (possible configuration error). Bit 16: Volume range exceeded (possible configuration error). Bit 17: Sensor amplitude out of range (possible hardware error). Bit 18: RHE firmware performance problem (possible hardware error). Bit 19: RHE firmware/hardware problem detected during selftest. Bit 20: CRC error found in flash memory used for Zeroing data. Bit 21: CRC error found in flash memory used for Totalizer data. Bit 22: Sensor not (yet) ready (sensor excitation or hardware problem). Bit 23: Special Function 1: Fraud Attempt Detected. Bit 24: Inconsistent calibration information for the 4-20mA interface provided. Bit 25: Pickup voltage below defined threshold detected. Multi-phase flow assumed. Bit 26 – 31: Reserved

Address	Abbreviation	Type	Full Name / Description
0x401E	Warnings	UINT32	<p>Warning Status: This register is a bit set which contains the non-critical warning information about operational states and may appear and clear during normal operation. The following bits are defined:</p> <ul style="list-style-type: none"> Bit 0: Density exceeds upper user warning limit. Bit 1: Mass flow exceeds upper user warning limit. Bit 2: Volume flow exceeds upper user warning limit. Bit 3: Tube temperature exceeds upper user warning limit. Bit 4: Torsion bar temperature exceeds upper user warning limit. Bits 5 – 7: Reserved. Bit 8: Mass totalizer exceeds upper user warning limit. Bit 9: Volume totalizer exceeds upper user warning limit. Bit 10: Reserved. Bit 11: Pressure Warning Range exceeded. Bits 12 – 14: Reserved. Bit 15: Current Output 1 Range Exceeded (possible configuration error). Bit 16: Density exceeds lower user warning limit. Bit 17: Mass flow exceeds lower user warning limit. Bit 18: Volume flow exceeds lower user warning limit. Bit 19: Tube temperature exceeds lower user warning limit. Bit 20: Torsion bar temperature exceeds lower user warning limit. Bit 21: Current Output 2 Range Exceeded (possible configuration error). Bits 22 – 23: Reserved. Bit 24: Mass totalizer exceeds lower user warning limit. Bit 25: Volume totalizer exceeds lower user warning limit. Bit 26: Reserved. Bit 27: Special density calculation out of defined limits. Bit 26: Reserved. Bit 29: Software performance problem detected. Bit 30: Density change exceeds set limit. Bit 31: Mass flow change exceeds set limit.

Address	Abbreviation	Type	Full Name / Description
0x4020	InfoStatus	UINT32	<p>Information Status: This register is a bit set which contains general information about operational states and may appear and clear during normal operation. The following bits are defined:</p> <ul style="list-style-type: none"> Bit 0: User is logged in via RS485 (User Level active). Bit 1: Service is logged in via RS485 (Service Level active). Bit 2: Factory is logged in via RS485 (Factory Level active). Bit 3: User is logged in via USB (User Level active). Bit 4: Service is logged in via USB (Service Level active). Bit 5: Factory is logged in via USB (Factory Level active). Bit 6: Reserved. Bit 7: Zeroing button pressed. Bits 8 – 10: Reserved. Bit 11: Current Output 1 not powered properly. Bit 12: Current Output 2 not powered properly. Bits 13 – 14: Reserved. Bit 15: Mass flow is zero, below cutoff limit. Bit 16: Flow direction indicator (forwards when set). Bits 17 – 21: Reserved. Bit 22: Custody Transfer Lock Switch active. Bit 23: Cause of last system reset is unknown. Bit 24: Last system reset was commanded (via Modbus). Bit 25: Last system reset was caused by a system/software failure. Bit 26: Last system reset was caused by a power cycle. Bit 27: Last system reset was caused by over- or under voltage on the CPU. Bit 28: Last system reset was caused by a power failure. Bit 29: Default data/parameter for Totalizer and zeroing used. Totalizer contents lost. Bit 30: CPLD logic selftest result OK. Bit 31: Totalizer/Zeroing flash memory selftest result OK.
0x4022	FirmwareChecksum	UINT32	<p>Checksum of the Firmware: 16-bit Checksum of the Firmware</p>
0x4024	BootloaderChecksum	UINT32	<p>Checksum of the Bootloader: 16-bit Checksum of the Bootloader</p>
0x4026	AssuranceFactor	FLOAT32	<p>Assurance Factor: System stability indicator in percent. This value is only computed when AssurancePresent (0x6090) is non-zero. Otherwise it is fixed to 100.0.</p>

Address	Abbreviation	Type	Full Name / Description
0x404A	PowerCycleCount	UINT32	Number of Power-Cycles: Number of power cycles experienced by the RHE hardware. This number is incremented at every power-on reset and is limited to 32767.

D.10 Totalizer

The totalizer of the RHE transmitter is used to accumulate the Mass Flow and Volumetric Flow rates. The net totalizer will add any flow in the positive direction. Any flow in the negative direction will be subtracted from it. The forward totalizer adds up only forward flows and the reverse totalizer adds up only the reverse flows. Volumetric flow and any totalized volume is correct only when proper density information is present in the system.

The MODBUS holding registers of the Totalizer group allow control and reset of the user totalizers plus configuration of warning limits.

D.10.1 Totalizer – MODBUS Holding Registers

D.10.1.1 Totalizer – MODBUS Holding Registers, USER Level

Address/ID	Abbreviation	Type	Full name / Description
0x6B00 [Q01] (2)	TotInvenReq	UINT32	<p>Totalizer State and Command: Reflects the status of the Totalizer. 0 = Reset and Stop 1 = Stopped/Not running 2 = Reset Start 3 = Started/Running</p> <p>This register automatically changes from the commanded state Reset/Start (2) into Started/Running (3) and from Reset/Stop (0) into Stopped/Not running (1). The default value is Reset/Start (2) which automatically starts the totalizer when the system defaults are loaded.</p> <p>The commanded change to the totalizer state may be combined with additional conditions encoded in following bits:</p> <p>Bit 8 (add 256): Reset the secondary totalizers SecTotNetMassDP and SecNetVolumeDP (0x4B2C and 0x4B30).</p> <p>Bit 9 (add 512): Before executing the totalizer command it is checked that the mass flow is zero (below the cut-off limit). When the mass flow is not zero a Modbus error 4 (failure) is returned.</p> <p>Bit 10 (add 1024): Before executing the totalizer command it is checked that the mass forward total in TotalMassFwd (0x4B00 or 0x4B14) is not zero. Otherwise a Modbus error 4 (failure) is returned.</p> <p>Bit 11 (add 2048): Before executing the totalizer command it is checked that the mass forward total in SecTotNetMassDP (0x4B2C) is not zero. Otherwise a Modbus error 4 (failure) is returned.</p> <p>Example: a value 258 written into this register will reset the secondary totalizers as well as the overall totalizers.</p> <p>Note, that a write to this register has an immediate effect which also will persist after a system reset or a power cycle.</p> <p>See also register CustodyLockProperty (0x6F08) for the effect of the custody transfer lock on the totalizer commands.</p> <p>When the totalizers are stopped and firmware version 2.10 or higher is installed, the pulse outputs in mode 1 to 6 and 15 to 18 are stopped, as well. Thus, the pulse output exactly follows the totalizers. The frequency output is not affected by the totalizer control settings.</p>
0x6B02 [T01]	TotInvenMassOvflw	FLOAT32	<p>User warning level for Total Mass Flow: User warning limit for the net total mass flow. When this register is set to 0.0 the warning is disabled. Default value is 0.0. A warning is indicated (bit 8 in Warnings (0x401E)) when the net total mass flow exceeds this value. This value is based on the unit specified in the MassUnit holding register (0x6104).</p>

Address/ID	Abbreviation	Type	Full name / Description
0x6B04 [T02]	TotInvenVolOvflw	FLOAT32	User warning level for Total Volume Flow: User warning limit for the net total volume flow. When this register is set to 0.0 the warning is disabled. Default value is 0.0. A warning is indicated (bit 9 in Warnings (0x401E) when the net total volume flow exceeds this value. This value is based on the unit specified in the VolumeUnit holding register (0x610C).

D.10.1.2 Totalizer – MODBUS Holding Registers, SERVICE Level

Address/ID	Abbreviation	Type	Full name / Description
0x6B08	TotPulseOffset	FLOAT32	Pulse Totalizer Offset: This value will be negated and used as initial value for the pulse totalizer when enabled by a specific value in SpecialFunction1 (0x6096) to enable Special Function 2, see extra document 8.2.1.33. This value is converted from (write) or to (read) by the unit specified in MassUnit holding register (0x6104). The default unit is kg.

D.10.2 Totalizer – MODBUS Input Registers

D.10.2.1 Totalizer – MODBUS Input Registers, USER Level

Address	Abbreviation	Type	Full name / Description
0x4B00	TotalMassFwd	FLOAT32	Forward Total Mass Flow: Totalizer value for Mass Flow where only forward mass flows are accumulated. This value is based on the unit specified in MassUnit holding register (0x6104). The contents of the totalizer will persist during a system reset or a power cycle.
0x4B02	TotalVolFwd	FLOAT32	Forward Total Volume Flow: Totalizer value for Volumetric Flow where only forward volumetric flows are accumulated. This value is converted from (write) or to (read) the unit specified in VolumeUnit holding register (0x610C). The contents of the totalizer will persist during a system reset or a power cycle..
0x4B04	TotInvenMassNet	FLOAT32	Total Mass Flow: Net totalizer value for Mass Flow. Forward mass flow is added to this totalizer, reverse mass flow is subtracted. This value is based on the unit specified in MassUnit holding register (0x6104). The contents of the totalizer will persist during a system reset or a power cycle.
0x4B06	TotInvenVolNet	FLOAT32	Total Volume Flow: Net totalizer value for Volumetric Flow. Forward volumetric flow is added to this totalizer, reverse volumetric flow is subtracted. This value is based on the unit specified in VolumeUnit holding register (0x610C). The contents of the totalizer will persist during a system reset or a power cycle.

Address	Abbreviation	Type	Full name / Description
0x4B08	TotalMassRev	FLOAT32	Reverse Total Mass Flow: Totalizer value for Mass Flow where only reverse mass flows are accumulated. This value is based on the unit specified in MassUnit holding register (0x6104). The contents of the totalizer will persist during a system reset or a power cycle.
0x4B0A	TotalVolRev	FLOAT32	Reverse Total Volume Flow: Totalizer value for Volumetric Flow where only reverse volumetric flows are accumulated. This value is based on the unit specified in VolumeUnit holding register (0x610C). The contents of the totalizer will persist during a system reset or a power cycle.
0x4B0C	MassA	FLOAT32	Mass A for Special Function 1: See extra document 8.2.1.11.
0x4B0E	MassAB	FLOAT32	Mass AB for Special Function 1: See extra document 8.2.1.11.
0x4B10	CorReq	FLOAT32	Required Correction for Special Function 1: See extra document 8.2.1.11.
0x4B12	CorAct	FLOAT32	Actual Correction for Special Function 1: See extra document 8.2.1.11.
0x4B14	TotalMassFwdDP	FLOAT64	Forward Total Mass Flow (double precision): Totalizer value for Mass Flow where only forward mass flows are accumulated. This value is based on the unit specified in MassUnit holding register (0x6104). The contents of the totalizer will persist during a system reset or a power cycle. This is the double precision version of register 0x4B00.
0x4B18	TotalVolFwdDP	FLOAT64	Forward Total Volume Flow (double precision): Totalizer value for Volumetric Flow where only forward volumetric flows are accumulated. This value is converted from (write) or to (read) the unit specified in VolumeUnit holding register (0x610C). The contents of the totalizer will persist during a system reset or a power cycle. This is the double precision version of register 0x4B02.
0x4B1C	TotInvenMassNetDP	FLOAT64	Total Mass Flow (double precision): Net totalizer value for Mass Flow. Forward mass flow is added to this totalizer, reverse mass flow is subtracted. This value is based on the unit specified in MassUnit holding register (0x6104). The contents of the totalizer will persist during a system reset or a power cycle. This is the double precision version of register 0x4B04.

Address	Abbreviation	Type	Full name / Description
0x4B20	TotInvenVolNetDP	FLOAT64	Total Volume Flow (double precision): Net totalizer value for Volumetric Flow. Forward volumetric flow is added to this totalizer, reverse volumetric flow is subtracted. This value is based on the unit specified in VolumeUnit holding register (0x610C). The contents of the totalizer will persist during a system reset or a power cycle. This is the double precision version of register 0x4B06.
0x4B24	TotalMassRevDP	FLOAT64	Reverse Total Mass Flow (double precision): Totalizer value for Mass Flow where only reverse mass flows are accumulated. This value is based on the unit specified in MassUnit holding register (0x6104). The contents of the totalizer will persist during a system reset or a power cycle. This is the double precision version of register 0x4B08.
0x4B28	TotalVolRevDP	FLOAT64	Reverse Total Volume Flow (double precision): Totalizer value for Volumetric Flow where only reverse volumetric flows are accumulated. This value is based on the unit specified in VolumeUnit holding register (0x610C). The contents of the totalizer will persist during a system reset or a power cycle. This is the double precision version of register 0x4B0A.
0x4B2C	SecTotNetMassDP	FLOAT64	Secondary Total Net Mass (double precision): Permanently running Net Totalizer for Mass. This totalizer is reset only when bit 8 (+256) is set in a totalizer status command, see TotInvenReq (0x6B00).
0x4B30	SecTotNetVolumeDP	FLOAT64	Secondary Total Net Volume (double precision): Permanently running Net Totalizer for Volume. This totalizer is reset only when bit 8 (+256) is set in a totalizer status command, see TotInvenReq (0x6B00).

D.11 Zeroing

The Zeroing Procedure is used to null out any phase difference measured by the RHE transmitter when no mass flow is present in the flow sensor. The baseline phase difference (zero point) is used as an offset to correct actual phase difference measured during flow before this is passed on for mass flow calculation. The MODBUS holding registers of this group contain the possibility to define temperature compensation for the zero point, and access to statistical information concerning the zero point. It is possible to enter a zero point via MODBUS and this may be used for diagnostic purposes.

The MODBUS input registers of this group contain information about the temperature corrected zero point as well as information about an ongoing Zeroing Procedure.

D.11.1 Zeroing – MODBUS Holding Registers

D.11.1.1 Zeroing – MODBUS Holding Registers, USER Level

Address	Abbreviation	Type	Full Name / Description
0x6718 [Q02]	ZeroingRequest	UINT32	Zeroing Request: A value of “1” indicates that a Zeroing Procedure is active. When the request is terminated this register automatically clears to 0. Writing a “1” to this location will start a Zeroing Procedure. Bit 10 in the SoftError input register (0x401C) indicates failure (when set) or success (when cleared) of the Zeroing Procedure. Zeroing may fail when the sensor is not (yet) ready or is not stable in operation.

D.11.1.2 Zeroing – MODBUS Holding Registers, SERVICE Level

Address/ID	Abbreviation	Type	Full Name / Description
0x6700	z00	FLOAT32	Zeroing coefficient for Term – Constant Factor: O-factor constant of Quick Tcor Compensation.
0x6702	z10	FLOAT32	Zeroing coefficient for Term T1: O-factor constant of Quick Tcor Compensation.
0x6704	z01	FLOAT32	Zeroing coefficient for term T2: O-factor constant of Quick Tcor Compensation.
0x6706	z11	FLOAT32	Zeroing coefficient for term T1 * T2: O-factor constant of Quick Tcor Compensation.
0x6708	z20	FLOAT32	Zeroing coefficient for term T1 * T1: O-factor constant of Quick Tcor Compensation.
0x670A	z02	FLOAT32	Zeroing coefficient for term T2 * T2: O-factor constant of Quick Tcor Compensation.
0x670C	z21	FLOAT32	Zeroing coefficient for term T1 * T1 * T2: O-factor constant of Quick Tcor Compensation.
0x670E	z12	FLOAT32	Zeroing coefficient for term T1 * T2 * T2: O-factor constant of Quick Tcor Compensation.
0x6710	z30	FLOAT32	Zeroing coefficient for term T1 * T1 * T1: O-factor constant of Quick Tcor Compensation.
0x6712	z03	FLOAT32	Zeroing coefficient for term T2 * T2 * T2: O-factor constant of Quick Tcor Compensation.

Address/ID	Abbreviation	Type	Full Name / Description
0x6714	ZeroRefTempTube	FLOAT32	Zeroing Reference Temperature Tube: Reference tube temperature for temperature correction of Zeroing in degrees Celsius. This value is based on the unit specified in TemperatureUnit holding register (0x6100).
0x6716	ZeroRefTempTorBar	FLOAT32	Zeroing Reference Temperature Torsion Bar: Reference torsion bar temperature for temperature correction of Zeroing in degrees Celsius. This value is based on the unit specified in TemperatureUnit holding register (0x6100).
0x671A	ZeroPointPhase	FLOAT32	Zero Point Phase: Mean value of Zero Point/Phase measurement. This is the main result of the Zeroing Procedure. The unit is 8ns.
0x671C	ZeroTubeTemp	FLOAT32	Zeroing Tube Temperature: Reference tube temperature at the time of Zeroing in degrees Celsius for use in temperature compensation of the zero phase. This value is based on the unit specified in TemperatureUnit holding register (0x6100).
0x671E	ZeroTorBarTemp	FLOAT32	Zeroing Torsion Bar Temperature: Reference torsion bar temperature at the time of Zeroing in degrees Celsius for use in temperature compensation of the zero phase. This value is based on the unit specified in TemperatureUnit holding register (0x6100).
0x6720	ZeroPointPeriod	FLOAT32	Zeroing Point Period: Determined sensor period during zeroing in 8ns units. This is a mean over all samples during the Zeroing Procedure
0x6722	ZeropointAmplitudeDrive	INT32	Zeropoint Amplitude Drive: Amplitude of Output during the last Zeroing Procedure. This parameter is kept for diagnostic purposes.
0x6724	VariancePhase	FLOAT32	Variance Phase: Square root of all differences between the mean phase value and all actual phase values during the last Zeroing Procedure. This is a measure of variance of phase during Zeroing and indicates the stability of the flow sensor. This value is kept for diagnostic purposes.
0x6726	VariancePeriod	FLOAT32	Variance Period: Square root of all differences between the mean frequency value and all actual frequency values during the last Zeroing Procedure. This is a measure of variance of sensor frequency during Zeroing and indicates the stability of the flow sensor. This value is kept for diagnostic purposes.
0x6728 [z01]	ZeroingNumberOfSamples	UINT32	Zeroing Number of Samples: Number of samples used for the Zeroing Procedure (in sensor periods). The higher the number, the more accurate Zeroing will be but the procedure will last longer. Values range from 1 to 1024. Default value is 500.

D.11.2 Zeroing – MODBUS Input Registers

D.11.2.1 Zeroing – MODBUS Input Registers, USER Level

Address	Abbreviation	Type	Full Name / Description
0x4700	TempCoeffZeroPoint	FLOAT32	Zero Point Temperature Correction Factor: Current factor for Zero Point correction after zero point temperature correction. This value depends upon measured temperatures.
0x4702	ZeroPoint	FLOAT32	Zero Point: Current Zero Point. This is a phase offset in 8ns units.
0x4704	ZeroPointPhase	FLOAT32	Zero Point Phase: Intermediate result of the Zeroing Procedure. This is a phase offset in 8ns units and is valid only during the Zeroing Procedure. Its final result will be the ZeroPointPhase (0x671A) value.
0x4706	ZeroingState	UINT32	State of the Zeroing Process: Current state of the Zeroing Process: 0: Zeroing done. Otherwise: Downcounter of zeroing steps/samples to be done.
0x4708	LastZeroPoint	FLOAT32	Last Zero Point: Zero point used before the last zeroing was performed This is a phase offset in 8ns units.

D.12 Unit Conversion

The RHE transmitter offers the possibility to present measurement results in a wide variety of standardized metric and imperial units. The desired units are selected in the unit conversion registers defined below. Not all MODBUS holding and input register information is affected by unit conversion. Register descriptions will indicate whether the value is effected by unit conversion along with the identification of the specific unit conversion register involved.

The numeric values assigned to the selection of different units are taken directly from Foundation Fieldbus specifications. Some additional unit types not found in the standard Foundation Fieldbus unit set are also included. These unit types have been assigned selection values beyond 40000.

The user is strongly advised to configure all unit conversion selections, save and activate them by system reset before any other configuration registers in the RHE transmitter are modified. This will avoid any misconfiguration issues due to unit confusion when values subject to conversion are changed. As a general rule, unit conversion selections should be made and activated separately from all other setup modifications.

D.12.1 Unit Conversion – MODBUS Holding Registers

D.12.1.1 Unit Conversion – MODBUS Holding Registers, USER Level

Address/ID	Abbreviation	Type	Full Name / Description
0x6100 [U01]	TemperatureUnit	UINT32	Unit for Temperature Conversion: Temperature unit conversion setting. Allowed values are: 1000: degrees Kelvin 1001: degrees Celsius (default) 1002: degrees Fahrenheit 1003: degrees Rankine
0x6102 [U02]	PressureUnit	UINT32	Unit for Pressure Conversion: Pressure unit conversion setting. Allowed values are: 1130: Pascal 1133: KiloPascal 1136: HectoPascal (default) 1137: Bar 1138: MilliBar 1139: Torr 1141: PSIA
0x6104 [U03]	MassUnit	UINT32	Unit for Mass Conversion: Mass unit conversion setting. Allowed values are: 1088: Kilogram (default) 1089: Gram 1090: Milligram 1092: Metric Tonne 1093: Ounce 1094: Pound 1095: Short Ton 40001: Metric Tonne (mt)

Address/ID	Abbreviation	Type	Full Name / Description
0x6106 [U04]	MassFlowUnit	UINT32	Unit for Mass Flow Conversion: Mass flow unit conversion settings. Allowed values are: 1318: Gram per second 1319: Gram per minute 1320: Gram per hour 1321: Gram per day 1322: Kilogram per second 1323: Kilogram per minute (default) 1324: Kilogram per hour 1325: Kilogram per day 1326: Metric tonne per second 1327: Metric tonne per minute 1328: Metric tonne per hour 1329: Metric tonne per day 1330: Pound per second 1331: Pound per minute 1332: Pound per hour 1333: Pound per day 1334: Short ton per second 1335: Short ton per minute 1336: Short ton per hour 1337: Short ton per day 42000: Ounce per second 42001: Ounce per minute 42002: Ounce per hour

Address/ID	Abbreviation	Type	Full Name / Description
0x6108 [U05]	DensityUnit	UINT32	Unit for Density Conversion Density unit conversion setting. Allowed values are: 1097: Kilogram per cubic meter (default) 1099: Kilogram per cubic decimeter 1100: Gram per cubic centimeter 1102: Metric tonne per cubic meter 1103: Kilogram per liter (SG, Specific Gravity) 1104: Gram per milliliter 1106: Pound per cubic inch 1107: Pound per cubic foot 1108: Pound per gallon 1112: Degrees Baume Heavy (since Firmware 1.57) 1112: Degrees Baume Light (since Firmware 1.57) 1113: Degrees API (since Firmware 1.43) 41000: Once Per Cubic Inch 41001: Degrees Brix (for the range from 0 to 40°Bx since Firmware 2.09) 41003: Kilogram per norm cubic meter (kg/Nm ³) 41004: Pound per standard cubic foot (lb/SCF)

0x610A [U06]	VolumeFlowUnit	UINT32	<p>Unit for Volume Flow Conversion: Volume flow conversion unit setting. Allowed values are:</p> <ul style="list-style-type: none"> 1347: Cubic meter per second 1348: Cubic meter per minute (default) 1349: Cubic meter per hour 1350: Cubic meter per day 1351: Liter per second 1352: Liter per minute 1353: Liter per hour 1354: Liter per day 1356: Cubic feet per second 1357: Cubic feet per minute 1358: Cubic feet per hour 1359: Cubic feet per day 33000: Standard cubic feet per second (SCFS) 1360: Standard cubic feet per minute (SCFM) 1361: Standard cubic feet per hour (SCFH) 33001: Standard cubic feet per day (SCFD) 1362: Gallon (US) per second 1363: Gallon (US) per minute 1364: Gallon (US) per hour 1365: Gallon (US) per day 1371: Barrel per second 1372: Barrel per minute 1373: Barrel per hour 1374: Barrel per day 1511: Milliliter per second (ml/s, cm³/s) 1512: Milliliter per minute (ml/s, cm³/mons) 1513: Milliliter per hour (ml/s, cm³/h) 1514: Milliliter per day (ml/s, cm³/d) 1522: Norm cubic meter per second (Nm³/s) 1523: Norm cubic meter per minute (Nm³/min) 1524: Norm cubic meter per hour (Nm³/h) 1527: Standard cubic meter per day (Sm³/d) since Firmware Release 2.08 1528: Standard cubic meter per minute (Sm³/min) since Firmware Release 2.08 1529: Standard cubic meter per hour (Sm³/h) since Firmware Release 2.08 1530: Standard cubic meter per day (Sm³/d) since Firmware Release 2.08 1489: Kilobarrel per hour
-----------------	----------------	--------	--

Address/ID	Abbreviation	Type	Full Name / Description
			1493: Kilobarrel per day 43000: Cubic inch per second 43001: Cubic inch per minute 43002: Cubic inch per hour
0x610C [U07]	VolumeUnit	UINT32	Unit for Volume Conversion: Volume unit conversion setting. Allowed values are: 1034: Cubic meter (default) 1035: Cubic decimeter 1036: Cubic centimeter 1037: Cubic millimeter 1038: Liter 1039: Centiliter 1040: Milliliter 1041: Hectoliter 1042: Cubic inch 1043: Cubic foot 1046: Gallon (US) 1051: Barrel 1053: Standard cubic feet (SCF) 1521: Norm cubic meter (Nm ³) 1526: Standard cubic meter (Sm ³) since Firmware Release 2.08

D.13 Current Output

The RHE20 transmitters may be ordered with two 4-20mA current interfaces. The 4-20mA current output interface may be used to transmit dynamic data such as flow or temperature via an analog signal to another system. The MODBUS holding registers allow the calibration and the configuration of this signal. The MODBUS input register of this group contains the current value of the output signal.

The modification of any test register will take effect immediately. The contents of these registers are not part of the setup stored in EEPROM and will return to their default values upon system reset or power cycle.

D.13.1 Current Output – MODBUS Holding Registers

D.13.1.1 Current Output – MODBUS Holding Registers, USER Level

Address/ID	Abbreviation	Type	Full Name / Description
0x6C06 [C01]	CurOutConfig	UINT32	Current Output 1 Configuration: Assigns an output channel to the current output 1: 0 – Analog output is off. 1 – Analog output is configured for Mass Flow (default). 2 – Analog output is configured for Volumetric Flow. 3 – Analog output is configured for Density. 4 – Analog output is configured for Tube Temperature. 5 – Analog output is configured for Torsion Bar Temperature. 6 – Drive Gain 7 - Assurance Factor (since release 2.07) 8 – Percent Main Substance (since release 2.17)
0x6C08 [C02]	CurOutCurMax	FLOAT32	Current Output 1 Current Maximum: Current at the maximum scale value in the range of 0.0 to 30.0. Default is 20.0.
0x6C0A [C03]	CurOutCurMin	FLOAT32	Current Output 1 Current Minimum: Current at the minimum scale value in the range of 4.0 to 16.0. Default is 4.0.
0x6C10 [C04]	CurOutCompMsFlwRtMax	FLOAT32	Current Output 1 Compensated Mass Flow Rate Maximum: Upper scale value used when CurOutConfig is set to 1. The mass flow value in this register corresponds to the CurOutCurMax value (i.e. it is the maximum output range). This value is based on the unit specified in the MassFlowUnit holding register (0x6106).
0x6C12 [C05]	CurOutCompMsFlwRtMin	FLOAT32	Current Output 1 Compensated Mass Flow Rate Minimum: Lower scale value used when CurOutConfig is set to 1. The mass flow value in this register corresponds to the CurOutCurMin value (i.e. it is the minimum output range). This value is based on the unit specified in the MassFlowUnit holding register (0x6106).
0x6C14 [C06]	CurOutCompVolMax	FLOAT32	Current Output 1 Compensated Volume Maximum: Upper scale value used when CurOutConfig is set to 2. The volumetric flow value in this register corresponds to the CurOutCurMax value (i.e. it is the maximum output range). This value is based on the unit specified in the VolumeFlowUnit holding register (0x610A).
0x6C16 [C07]	CurOutCompVolMin	FLOAT32	Current Output 1 Compensated Volume Minimum: Lower scale value used when CurOutConfig is set to 2. The volumetric flow value in this register corresponds to the CurOutCurMin value (i.e. it is the minimum output range). This value is converted from (write) or to (read) the unit specified in the VolumeFlowUnit holding register (0x610A).

Address/ID	Abbreviation	Type	Full Name / Description
0x6C18 [C08]	CurOutDenMax	FLOAT32	Current Output 1 Density Maximum: Upper scale value used when CurOutConfig is set to 3. The density value in this register corresponds to the CurOutCurMax value (i.e. it is the maximum output range). This value is based on the unit specified in the DensityUnit holding register (0x6108).
0x6C1A [C09]	CurOutDenMin	FLOAT32	Current Output 1 Density Minimum: Lower scale value used when CurOutConfig is set to 3. The density value in this register corresponds to the CurOutCurMin value (i.e. it is the minimum output range). This value is based on the unit specified in the DensityUnit holding register (0x6108).
0x6C1C [C10]	CurOutCompTubeTempMax	FLOAT32	Current Output 1 Compensated Tube Temperature Maximum: Upper scale value used when CurOutConfig is set to 4. The tube temperature value in this register corresponds to the CurOutCurMax value (i.e. it is the maximum output range). This value is based on the unit specified in the TemperatureUnit holding register (0x6100).
0x6C1E [C11]	CurOutCompTubeTempMin	FLOAT32	Current Output 1 Compensated Tube Temperature Minimum: Lower scale value used when CurOutConfig is set to 4. The tube temperature value in this register corresponds to the CurOutCurMin value (i.e. it is the minimum output range). This value is based on the unit specified in the TemperatureUnit holding register (0x6100).
0x6C20 [C12]	CurOutCompTorTempMax	FLOAT32	Current Output 1 Compensated Torsion Bar Temperature Maximum: Upper scale value used when CurOutConfig is set to 5. The torsion bar temperature value in this register corresponds to the CurOutCurMax value (i.e. it is the maximum output range). This value is based on the unit specified in the TemperatureUnit holding register (0x6100).
0x6C22 [C13]	CurOutCompTorTempMin	FLOAT32	Current Output 1 Compensated Torsion Bar Temperature Minimum: Lower scale value used when CurOutConfig is set to 4. The torsion bar temperature value in this register corresponds to the CurOutCurMin value (i.e. it is the minimum output range). This value is based on the unit specified in the TemperatureUnit holding register (0x6100).
0x6C24	GUIOnBoardTempMax	FLOAT32	GUI On Board Temperature Maximum: On-Board Temperature maximum scale value. Used only by RHEComPro program for scaling the display. Default is 60.0 degree Celsius. This value is based on the unit specified in the TemperatureUnit holding register (0x6100).
0x6C26	GUIOnBoardTempMin	FLOAT32	GUI On Board Temperature Minimum: On-Board Temperature minimum scale value. Used only by RHEComPro program for scaling the display. Default is -20.0 degree Celsius. This value is based on the unit specified in the TemperatureUnit holding register (0x6100).

Address/ID	Abbreviation	Type	Full Name / Description
0x6C28 [C14]	CurOutFireState	UINT32	<p>Current Output 1 Fire State: Determines the behavior (“fail high” or “fail low”) and value of the analog output when analog range is exceeded (values 1 to 5), i.e. the output is above the upper (CurOutCurMax) or is below the lower (CurOutCurMin) limits, or an error condition exists in the SoftError (0x401C) or ErrorStatus (0x401A) fields (values 6 to 10). 0 – Output tracks the signal and clamps at the CurOutMaxCur and CurOutMinCur values when its range is exceeded (default). 1 – 22 mA : range exceeded only 2 – 0 mA : range exceeded only (not for RHE20, has 3.2mA minimum) 3 – 2 mA : range exceeded only (not for RHE20, has 3.2mA minimum) 4 – 3.2 mA : range exceeded only 5 – 3.6 mA : range exceeded only 6– 22 mA : error condition exists only 7– 0 mA : error condition exists only (not for RHE20, has 3.2mA minimum) 8– 2 mA : error condition exists only (not for RHE20, has 3.2mA minimum) 9 – 3.2 mA : error condition exists only 10 – 3.6 mA : error condition exists only 11 – Engage PID Control For the PID Control the measurement selection in CurOutConfig (0x6C06) must be less than 5.</p>
0x6C2A	CurOutSlewRate	FLOAT32	<p>Current Output Slew 1 Rate: Currently unused parameter.</p>
0x6C2C [C15]	CurOutGainMax	FLOAT32	<p>Current Output 1 Gain Maximum: Upper scale value used when CurOutConfig is set to 6. When the drive gain in percent (440E) is equal to the value in this register the CurOutCurMax value (usually 20mA) is outputted on the current output. This value has no associated unit conversion. The default is 100 for 100%, the maximum possible gain value.</p>
0x6C2E [C16]	CurOutGainMin	FLOAT32	<p>Current Output 1 Gain Minimum: Lower scale value used when CurOutConfig is set to 6. When the drive gain in percent (440E) is equal to the value in this register the CurOutCurMin value (usually 4mA) is outputted on the current output. This value has no associated unit conversion. The default is 0 for 0%, the minimum possible gain value.</p>
0x6C30 [C17]	CurOutDampingTau	FLOAT32	<p>Current Output 1 Damping Tau: Time constant (Tau) of the current output damping in seconds. An exponential damping mechanism is used within a defined band, see CurOutDampingBand (0x6C32). When the output values leave the defined band the damping is disabled. A value of 0.0 disables the damping.</p>

Address/ID	Abbreviation	Type	Full Name / Description
0x6C32 [C18]	CurOutDampingBand	FLOAT32	Current Output 1 Damping Band: Defines the band range for the damping of the current output in percent of the range between CurOutCurMin (0x6C0A) and CurOutCurMax (0x6C08) 20mA. A value of 100 makes sure that the values never leave the band and that the damping always is active.
0x6C34 [C19]	CurOutAssuranceMax	FLOAT32	Current Output Assurance Maximum: Upper scale value used when CurOutConfig is set to 7. When the Assurance Factor is equal to the value in this register the CurOutCurMax value (usually 20mA) is outputted on the current output. The unit of this value is percent.
6C36 [C20]	CurOutAssuranceMin	FLOAT32	Current Output Assurance Minimum: Lower scale value used when CurOutConfig is set to 7. When the Assurance Factor is equal to the value in this register the CurOutCurMin value (usually 4mA) is outputted on the current output. The unit of this value is percent.
0x6C46 [B01]	CurOut2Config	UINT32	Current Output 2 Configuration: Assigns an output channel to the current output 2: 0 – Analog output is off. 1 – Analog output is configured for Mass Flow (default). 2 – Analog output is configured for Volumetric Flow. 3 – Analog output is configured for Density. 4 – Analog output is configured for Tube Temperature. 5 – Analog output is configured for Torsion Bar Temperature. 6 – Drive Gain 7 – Assurance Factor (since release 2.07) 8 – Percent Main Substance (since release 2.17)
0x6C48 [B02]	CurOut2CurMax	FLOAT32	Current Output 2 Current Maximum: Current at the maximum scale value in the range of 0.0 to 30.0. Default is 20.0.
0x6C4A [B03]	CurOut2CurMin	FLOAT32	Current Output 1 Current Minimum: Current at the minimum scale value in the range of 4.0 to 16.0. Default is 4.0.
0x6C50 [B04]	CurOut2CompMsFlwRtMax	FLOAT32	Current Output 2 Compensated Mass Flow Rate Maximum: Upper scale value used when CurOut2Config is set to 1. The mass flow value in this register corresponds to the CurOut2CurMax value (i.e. it is the maximum output range). This value is based on the unit specified in the MassFlowUnit holding register (0x6106).
0x6C52 [B05]	CurOut2CompMsFlwRtMin	FLOAT32	Current Output 2 Compensated Mass Flow Rate Minimum: Lower scale value used when CurOut2Config is set to 1. The mass flow value in this register corresponds to the CurOut2CurMin value (i.e. it is the minimum output range). This value is based on the unit specified in the MassFlowUnit holding register (0x6106).

Address/ID	Abbreviation	Type	Full Name / Description
0x6C54 [B06]	CurOut2CompVolMax	FLOAT32	Current Output 2 Compensated Volume Maximum: Upper scale value used when CurOut2Config is set to 2. The volumetric flow value in this register corresponds to the CurOut2CurMax value (i.e. it is the maximum output range). This value is based on the unit specified in the VolumeFlowUnit holding register (0x610A).
0x6C56 [B07]	CurOut2CompVolMin	FLOAT32	Current Output 2 Compensated Volume Minimum: Lower scale value used when CurOut2Config is set to 2. The volumetric flow value in this register corresponds to the CurOut2CurMin value (i.e. it is the minimum output range). This value is converted from (write) or to (read) the unit specified in the VolumeFlowUnit holding register (0x610A).
0x6C58 [B08]	CurOut2DenMax	FLOAT32	Current Output 2 Density Maximum: Upper scale value used when CurOut2Config is set to 3. The density value in this register corresponds to the CurOut2CurMax value (i.e. it is the maximum output range). This value is based on the unit specified in the DensityUnit holding register (0x6108).
0x6C5A [B09]	CurOut2DenMin	FLOAT32	Current Output 2 Density Minimum: Lower scale value used when CurOut2Config is set to 3. The density value in this register corresponds to the CurOut2CurMin value (i.e. it is the minimum output range). This value is based on the unit specified in the DensityUnit holding register (0x6108).
0x6C5C [B10]	CurOut2CompTubeTempMax	FLOAT32	Current Output 2 Compensated Tube Temperature Maximum: Upper scale value used when CurOut2Config is set to 4. The tube temperature value in this register corresponds to the CurOut2CurMax value (i.e. it is the maximum output range). This value is based on the unit specified in the TemperatureUnit holding register (0x6100).
0x6C5E [B10]	CurOut2CompTubeTempMin	FLOAT32	Current Output 2 Compensated Tube Temperature Minimum: Lower scale value used when CurOut2Config is set to 4. The tube temperature value in this register corresponds to the CurOut2CurMin value (i.e. it is the minimum output range). This value is based on the unit specified in the TemperatureUnit holding register (0x6100).
0x6C60 [B12]	CurOut2CompTorTempMax	FLOAT32	Current Output 2 Compensated Torsion Bar Temperature Maximum: Upper scale value used when CurOut2Config is set to 5. The torsion bar temperature value in this register corresponds to the CurOut2CurMax value (i.e. it is the maximum output range). This value is based on the unit specified in the TemperatureUnit holding register (0x6100).
0x6C62 [B13]	CurOut2CompTorTempMin	FLOAT32	Current Output 2 Compensated Torsion Bar Temperature Minimum: Lower scale value used when CurOut2Config is set to 4. The torsion bar temperature value in this register corresponds to the CurOut2CurMin value (i.e. it is the minimum output range). This value is based on the unit specified in the TemperatureUnit holding register (0x6100).
0x6C64	GUIOnBoardTemp2Max	FLOAT32	GUI On Board Temperature 2 Maximum: On-Board Temperature maximum scale value. Used only by RHEComPro program for scaling the display. Default is 60.0 degree Celsius. This value is based on the unit specified in the TemperatureUnit holding register (0x6100).

Address/ID	Abbreviation	Type	Full Name / Description
0x6C66	GUIOnBoardTemp2Min	FLOAT32	GUI On Board Temperature 2 Minimum: On-Board Temperature minimum scale value. Used only by RHEComPro program for scaling the display. Default is -20.0 degree Celsius. This value is based on the unit specified in the TemperatureUnit holding register (0x6100).
0x6C68 [B14]	CurOut2FireState	UINT32	Current Output 2 Fire State: Determines the behavior (“fail high” or “fail low”) and value of the analog output 2 when analog range is exceeded (values 1 to 5), i.e. the output is above the upper (CurOut2CurMax) or is below the lower (CurOut2CurMin) limits, or an error condition exists in the SoftError (0x401C) or ErrorStatus (0x401A) fields (values 6 to 10). 0 – Output tracks the signal and clamps at the CurOutMaxCur and CurOutMinCur values when its range is exceeded (default). 1 – 22 mA : range exceeded only 2 – 0 mA : range exceeded only (not for RHE20, has 3.2mA minimum) 3 – 2 mA : range exceeded only (not for RHE20, has 3.2mA minimum) 4 – 3.2 mA : range exceeded only 5 – 3.6 mA : range exceeded only 6– 22 mA : error condition exists only 7– 0 mA : error condition exists only (not for RHE20, has 3.2mA minimum) 8– 2 mA : error condition exists only (not for RHE20, has 3.2mA minimum) 9 – 3.2 mA : error condition exists only 10 – 3.6 mA : error condition exists only 11 – Engage PID Control For the PID Control the measurement selection in CurOut2Config (0x6C46) must be less than 5.
0x6C6A	CurOut2SlewRate	FLOAT32	Current Output 2 Slew Rate: Currently unused parameter.
0x6C6C [B15]	CurOut2GainMax	FLOAT32	Current Output 2 Gain Maximum: Upper scale value used when CurOut2Config is set to 6. When the drive gain in percent (440E) is equal to the value in this register the CurOut2CurMax value (usually 20mA) is outputted on the current output. This value has no associated unit conversion. The default is 100 for 100%, the maximum possible gain value.
0x6C6E [B16]	CurOut2GainMin	FLOAT32	Current Output 2 Gain Minimum: Lower scale value used when CurOut2Config is set to 6. When the drive gain in percent (440E) is equal to the value in this register the CurOut2CurMin value (usually 4mA) is outputted on the current output. This value has no associated unit conversion. The default is 0 for 0%, the minimum possible gain value.

Address/ID	Abbreviation	Type	Full Name / Description
0x6C74 [B19]	CurOut2AssuranceMax	FLOAT32	Current Output 2 Assurance Maximum: Upper scale value used when CurOut2Config is set to 7. When the Assurance Factor is equal to the value in this register the CurOut2CurMax value (usually 20mA) is outputted on the current output. The unit of this value is percent.
0x6C76 [B20]	CurOut2AssuranceMin	FLOAT32	Current Output 2 Assurance Minimum: Lower scale value used when CurOut2Config is set to 7. When the Assurance Factor is equal to the value in this register the CurOut2CurMin value (usually 4mA) is outputted on the current output. The unit of this value is percent.
0x6C80	CurOutPIDInitTarget	FLOAT32	Current Output PID Initial Target: Initial target value for the PID controller of the first current output interface. This value must be in the range of CurOutCurMin (0x6C0A) to CurOutCurMax (0x6C08), otherwise a configuration error is signaled. This value and the registers in the range of 0x6C80 to 0x6C88 are used only when CurOutFireState (0x6C28) is set to 11.
0x6C82	CurOutPIDCurrTarget	FLOAT32	Current Output PID Current Target: Current target value for the PID controller of the first current output interface. This register is initialized to the value in CurOutPIDInitTarget (0x6C80) and may be overwritten any time. A new value will have an immediate effect.
0x6C84	CurOutPIDPropFactor	FLOAT32	Current Output PID Proportional Factor: Proportional factor for the PID controller of the first current output interface. This value may be negative for inverted controls loops.
0x6C86	CurOutPIDIntFactor	FLOAT32	Current Output PID Integral Factor: Integral factor for the PID controller of the first current output interface. This value may be negative for inverted controls loops.
0x6C88	CurOutPIDDiffFactor	FLOAT32	Current Output PID Differential Factor: Differential factor for the PID controller of the first current output interface. This value may be negative for inverted controls loops.
0x6CA0	CurOut2PIDInitTarget	FLOAT32	Current Output 2 PID Initial Target: Initial target value for the PID controller of the second current output interface. This value must be in the range of CurOut2CurMin (0x6C4A) to CurOut2CurMax (0x6C48), otherwise a configuration error is signaled. This value and the registers in the range of 0x6CA0 to 0x6CA8 are used only when CurOut2FireSate (0x6C68) is set to 11.

Address/ID	Abbreviation	Type	Full Name / Description
0x6CA2	CurOut2PIDCurrTarget	FLOAT32	Current Output 2 PID Current Target: Current target value for the PID controller of the second current output interface. This register is initialized to the value in CurOut2PIDInitTarget (0x6A80) and may be overwritten any time. A new value will have an immediate effect.
0x6CA4	CurOut2PIDPropFactor	FLOAT32	Current Output 2 PID Proportional Factor: Proportional factor for the PID controller of the second current output interface. This value may be negative for inverted controls loops.
0x6CA6	CurOut2PIDIntFactor	FLOAT32	Current Output 2 PID Integral Factor: Integral factor for the PID controller of the second current output interface. This value may be negative for inverted controls loops.
0x6CA8	CurOut2PIDDiffFactor	FLOAT32	Current Output 2 PID Differential Factor: Differential factor for the PID controller of the second current output interface. This value may be negative for inverted controls loops.

D.13.1.2 Current Output – MODBUS Holding Registers, SERVICE Level

Address/ID	Abbreviation	Type	Full Name / Description
0x6C00	CurOutDiffFiThr	UINT32	Current Output 1 Difference Fault Integrator Threshold: Currently unused parameter. Default is 10.
0x6C02	CurrOutTestStart	UINT32	Current Output 1 Test Start: Used for output calibration and test: 0 – Stop calibration, normal operation (default). 1 – Start Calibration, output CurrOutTestvalue as specified. 2 – Start Test/Verification, output CurrOutTestvalue calibrated with the help of CurOutTrim and CurOutGain. When set to 1 or 2 this overrides any other activities on the current output.
0x6C04	CurrOutTestValue	FLOAT32	Current Output 1 Test Value: Current output test value in the range of 0.0 to 24.0. This value is output on the current output when CurrOutTestStart (0x6C02) is set to 1 or 2.
0x6C0C [c01]	CurOutTrim	FLOAT32	Current Output 1 Trim: Actual value measured external to the RHE transmitter when CurrOutTestValue = 4.0. This value is set as the first step of the current output calibration process. Range is from -1.0 to +30.0, default is 4.0.

Address/ID	Abbreviation	Type	Full Name / Description
0x6C0E [c02]	CurOutGain	FLOAT32	Current Output 1 Gain: Actual value measured external to the RHE transmitter when CurrOutTestValue = 20.0. This value is set as the second step of the current output calibration process. Range is from 0.0 to 30.0, default is 20.0.
0x6C40	CurOut2DiffFiThr	UINT32	Current Output 2 Difference Fault Integrator Threshold: Currently unused parameter. Default is 10.
0x6C42	CurrOut2TestStart	UINT32	Current Output 2 Test Start: Used for output calibration and test: 0 – Stop calibration, normal operation (default). 1 – Start Calibration, output CurrOutTestvalue as specified. 2 – Start Test/Verification, output CurrOutTestvalue calibrated with the help of CurOut2Trim and CurOut2Gain. When set to 1 or 2 this overrides any other activities on the current output.
0x6C44	CurrOut2TestValue	FLOAT32	Current Output 2 Test Value: Current output test value in the range of 0.0 to 24.0. This value is output on the current output when CurrOut2TestStart (0x6C02) is set to 1 or 2.
0x6C4C [b01]	CurOut2Trim	FLOAT32	Current Output 2 Trim: Actual value measured external to the RHE transmitter when CurrOut2TestValue = 4.0. This value is set as the first step of the current output calibration process. Range is from -1.0 to +30.0, default is 4.0.
0x6C4E [b02]	CurOut2Gain	FLOAT32	Current Output 2 Gain: Actual value measured external to the RHE transmitter when CurrOut2TestValue = 20.0. This value is set as the second step of the current output calibration process. Range is from 0.0 to 30.0, default is 20.0.

D.13.2 Current Output – MODBUS Input Registers

D.13.2.1 Current Output – MODBUS Input Registers, USER Level

Address	Abbreviation	Type	Full Name / Description
0x4C00	CurrOut	FLOAT32	Current Output 1 Value: Current output 1 value before the application of the calibration information (gain and trim) as well as the firestate condition in mA for diagnostic purposes.
0x4C02	CurrOut2	FLOAT32	Current Output 2 Value: Current output 2 value before the application of the calibration information (gain and trim) as well as the firestate condition in mA for diagnostic purposes.

D.14 Digital and Versatile Digital Outputs

The setup parameters of the Digital and Versatile Digital Output controls the behavior of the digital outputs labelled “Outputs” 1 to 4. Digital outputs 1 – 4 are optionally ordered with the RHE transmitter – see parameter DigOutPresent (0x6088) to check if they are installed. The outputs can be configured for following functionalities:

Output	Functionality
1 and 2	<p>Channels 0 and 1 pulse or frequency output. Pulses are generated depending on the measured mass or volume. Pulse configuration is not intended to indicate a flow rate. When configured for frequency output the output frequency is scaled to mass or volume flow. Channel 0 may be combined with Channel 1 for a 90° or 180° phase shifted output which also can also be used to determine flow direction. Output 1 is controlled by the parameters starting with “VersDigOutCh0” in the name and Output 2 is controlled by the parameters starting with “VersDigOutCh1”.</p> <p>When the pulse/frequency output is disabled (0 in VersDigOutCh0Config [0x6D06] or VersDigOutCh1Config [0x6E06]) these outputs behave like the status output 3 and 4. In this case output 1 is controlled by the parameter set the names of which starts with “DigOutChA” and output 2 is controlled by the parameter set named “DigOutChB”.</p>
3	<p>A simple (off/on) digital status output (parameter set 1 starting with “DigOutCh1”) which can be programmed to indicate various alarm states of the RHE transmitter. The default behavior is the indication of flow direction. When programmed for an alarm state the upper and lower bounds for the alarm must be specified as well as the alarm type (setpoint, inband, outband).</p>
4	<p>A simple (off/on) digital status output (parameter set 0 starting with “DigOutCh0”) which can be programmed to indicate various alarm states of the RHE transmitter. The default behavior is the indication of error state and is activated when either of the status registers ErrorStatus (0x401A) or SoftError (0x401C) contains a set error indication (bit). When programmed for a specific alarm state, the upper and lower bounds for the alarm must be specified as well as the alarm type (setpoint, inband, outband).</p>

The input registers belonging to the Digital and Versatile Digital Outputs can be used to monitor the state of the pulse and status outputs. They are provided for diagnostic purposes.

Any parameters that are used to start a test mode will take effect immediately when they are set. These parameters are not stored in the internal EEPROM and their setting will revert to their default values after a system reset or power cycle.

In order to ascertain that no pulses are lost when the RHE transmitter is installed and used in an application, a test should be made with the highest intended frequency (maximum is 10kHz) and the waveform of the pulses should be checked with an oscilloscope. A pull-up resistor value should be chosen such that pulses are certain to be counted with a proper safety margin. Please refer to the RHE type-specific installation manual for the electrical properties of the digital outputs.

D.14.1 Versatile Digital Output – MODBUS Holding Registers

D.14.1.1 Versatile Digital Output – MODBUS Holding Registers, USER Level

Address/ID	Abbreviation	Type	Full Name / Description
0x6D06 [R01]	VersDigOutCh0Config	UINT32	<p>Versatile Digital Output Channel 0 Configuration: Used to assign different functions to the pulse output. In simple pulse mode, Pulse1 and Pulse2 operate independently. In phase shift mode, Pulse1 and Pulse2 work together to produce the desired pulse output relationship. In phase shift mode, both outputs (Pulse1 & Pulse2) should be set to the same mode.</p> <p>0: Pulse output is off. 1: Mass Flow – Simple Pulse, Forward Flow. 2: Volume Flow – Simple Pulse, Forward Flow. 3: Mass Flow – Pulse1 & Pulse2 90 Degrees phase shift. 4: Volume Flow – Pulse1 & Pulse2 90 Degrees phase shift. 5: Mass Flow – Simple Pulse, Reverse Flow. 6: Volume Flow – Simple Pulse, Reverse Flow. 7: Mass Flow Rate Fast Frequency Output. 8: Volumetric Flow Rate Fast Frequency Output. 9: Density Fast Frequency Output. 10: Mass Flow Rate Slow Frequency Output. 11: Volumetric Flow Rate Slow Frequency Output. 12: Density Slow Frequency Output. 13: Mass Flow Rate RHE Compatibility Mode Frequency Output. 14: Volumes Flow Rate RHE Compatibility Mode Frequency Output. 15: Mass Flow – Pulse1 & Pulse2 180 Degrees phase shift, Forward Flow. 16: Volume Flow – Pulse1 & Pulse2 180 Degrees phase shift, Forward Flow. 17: Mass Flow – Pulse1 & Pulse2 180 Degrees phase shift, Reverse Flow. 18: Volume Flow – Pulse1 & Pulse2 180 Degrees phase shift, Reverse Flow.</p>
0x6D08 [R02]	VersDigOutCh0PIsMass	FLOAT32	<p>Versatile Digital Output Channel 0 Pulse Mass: Channel 0 pulse rate specification when VersDigCh0Config equals 1, 3, or 5. The value specifies the mass which shall be equivalent to one pulse. The unit is converted and displayed with the current mass unit setting in MassUnit (0x6104). Example: When set to 0.001kg (1 gram) a totalized mass transfer of 1kg will cause 1000 pulses to be output.</p>

Address/ID	Abbreviation	Type	Full Name / Description
0x6D0A [R03]	VersDigOutCh0PIsVolume	FLOAT32	Versatile Digital Output Channel 0 Pulse Volume: Channel 0 pulse rate specification when VersDigCh0Config equals 2, 4, or 6. The value specifies the volume which shall be equivalent to one pulse. The unit is converted and displayed with the current volume unit setting in VolumeUnit (0x610C). Example: When set to 0.001m ³ (1 liter) a totalized volume transfer of 1m ³ will cause 1000 pulses to be outputted.
0x6DOC [R04]	VersDigOutCh0FreqMassFlwRt	FLOAT32	Versatile Digital Output Channel 0 Frequency Mass Flow Rate: Channel 0: Mass flow which corresponds to the reference frequency VersDigOutCh0FreqReference when VersDigCh0Config equals 7 or 10. The unit is converted and displayed with the current mass flow unit setting in MassFlowUnit (0x6106).
0x6D0E [R05]	VersDigOutCh0FreqVolFlwRt	FLOAT32	Versatile Digital Output Channel 0 Frequency Volumetric Flow Rate: Channel 0: Volume flow which corresponds to the reference frequency VersDigOutCh0FreqReference when VersDigCh0Config equals 8 or 11. The unit is converted and displayed with the current mass flow unit setting in VolumeFlowUnit (0x610A).
0x6D10 [R06]	VersDigOutCh0FreqDensity	FLOAT32	Versatile Digital Output Channel 0 Frequency Density: Channel 0: Density which corresponds to the reference frequency VersDigOutCh0FreqReference when VersDigCh0Config equals 9 or 12. The unit is converted and displayed with the current mass flow unit setting in DensityUnit (0x6108).
0x6D12 [R07]	VersDigOutCh0FreqReference	FLOAT32	Versatile Digital Output Channel 0 Frequency Reference: Channel 0: The reference frequency is the number of pulses per unit of the selected data source. The range is from 0.0 (invalid) to 10000.0. The default is 200.0.
0x6D14 [R08]	VersDigOutCh0NegateOutput	UINT32	Versatile Digital Output Channel 0 Inverse Pulses: Channel 0: Will cause the output of inverted pulses since Firmware Version 1.66. Following values are possible: 0 (default): positive/normal pulses. 1: inverted/negated pulses. 2: positive/normal pulses, only positive flow at 90° configuration. 3: inverted/negated pulses, only positive flow at 90° configuration.
0x6D16 [R09]	VersDigOutCh0MaxPulseWidth	UINT32	(Since V1.67) Versatile Digital Output Channel 0 Maximum Pulse Width: Maximum pulse width for pulse and frequency configurations in the range from 50 to 4000μs. A value below 50 specifies a 50% duty cycle of the outputted signal. Default is 0 and thus a 50% duty cycle is generated.

Address/ID	Abbreviation	Type	Full Name / Description
0x6D1C [I01]	DigOutCh0Config	UINT32	<p>Digital Output Channel 0 Configuration: Alarm Channel 0 (ERR output) configuration: 0: Error indication (default) 1: Mass flow alarm 2: Volumetric flow alarm 3: Density alarm 4: Tube temperature alarm 5: Torsion bar temperature alarm 6: Pressure 7: Forward Mass Totalizer TotalMassFwd (0x4B00) for Batch Mode 8: Forward Volume Totalizer TotalVolFwd (0x4B02) for Batch Mode 9: Fatal errors or Zeroing force output low, else high. 10: Fatal errors or Zeroing force output high, else low. 11: Assurance Factor Alarm.</p> <p>For the values 1 to 8 and 11 the "Pulse Output 1" is pulled low when the alarm condition specified in DigOutChBAlmType, DigOutChBAlmLow, and DigOutChBAlmHigh becomes true.</p>
0x6D1E [I02]	DigOutCh0AlmType	UINT32	<p>Digital Output Channel 0 Alarm Type: Alarm Channel 0: Digital Alarm Type: 0: Setpoint alarm (hysteresis, default) – Alarm is indicated when the output is higher than DigOutCh0AlmHigh and cleared when it returns below DigOutCh0AlmLow. 1: Inband alarm – Alarm is indicated when the output is in the range from DigOutCh0AlmLow to DigOutCh0AlmHigh. 2: Outband alarm – Alarm is indicated when the output is outside the range DigOutCh0AlmLow and DigOutCh0AlmHigh.</p> <p>An indicated alarm on channel 0 pulls the digital output 4 labeled "ERR" low.</p>

Address/ID	Abbreviation	Type	Full Name / Description
0x6D20 [I03]	DigOutCh0AlmLow	FLOAT32	<p>Digital Output Channel 0 Alarm Low: Initial alarm low value for channel 0, see DigOutCh0AlmType (0x6D1E). There is no unit conversion for this register. The unit depends on the DigOutCh0Config (0x6D1C) setting:</p> <ul style="list-style-type: none"> 1: kg/min 2: m³/min 3: kg/m³ 4: Degrees Celsius 5: Degrees Celsius 6: Pascal 7: kg 8: m³ 11: % <p>The same units are used for all other digital status outputs 1, A, and B depending on DigOutCh1Config, DigOutChAConfig, DigOutChBConfig respectively. Will be used to set DigOutCh0AlmLowCurr to its initial value.</p>
0x6D22 [I04]	DigOutCh0AlmHigh	FLOAT32	<p>Digital Output Channel 0 Alarm High: Initial alarm high value for channel 0 see DigOutCh0AlmType (0x6D1E). See DigOutCh0AlmLow (0x6D20) for the unit specification. Will be used to set DigOutCh0AlmHighCurr to its initial value.</p>
0x6D24	DigOutCh0AlmLowCurr	FLOAT32	<p>Current Digital Output Channel 0 Alarm Low: Current alarm low value for channel 0 see DigOutCh0AlmType (0x6D1E). See DigOutCh0AlmLow (0x6D20) for the unit specification. Will be initially set to DigOutCh0AlmLow (0x6D20). A write of a new value has an immediate effect.</p>
0x6D26	DigOutCh0AlmHighCurr	FLOAT32	<p>Current Digital Output Channel 0 Alarm High: Current alarm high value for channel 0, see DigOutCh0AlmType (0x6D20). See DigOutCh0AlmLow (0x6D20) for the unit specification. Will be initially set to DigOutCh0AlmHigh (0x6D22). A write of a new value has an immediate effect.</p>

Address/ID	Abbreviation	Type	Full Name / Description
0x6D34 [K01]	DigOutChAConfig	UINT32	<p>Digital Output Channel A Configuration: Alarm Channel A configuration: 0: Error indication (default) 1: Mass flow alarm 2: Volumetric flow alarm 3: Density alarm 4: Tube temperature alarm 5: Torsion bar temperature alarm 6: Pressure 7: Forward Mass Totalizer TotalMassFwd (0x4B00) for Batch Mode 8: Forward Volume Totalizer TotalVolFwd (0x4B02) for Batch Mode 9: Fatal errors or Zeroing force output low, else high. 10: Fatal errors or Zeroing force output high, else low. 11: Assurance Factor Alarm.</p> <p>For the values 1 to 8 and 11 the "Pulse Output 1" is pulled low when the alarm condition specified in DigOutChBAImType, DigOutChBAImLow, and DigOutChBAImHigh becomes true.</p>
0x6D36 [K02]	DigOutChAAImType	UINT32	<p>Digital Output Channel A Alarm Type: Alarm Channel A: Digital Alarm Type: 0: Setpoint alarm (hysteresis, default) – Alarm is indicated when the output is higher than DigOutChAAImHigh and cleared when it returns below DigOutChAAImLow. 1: Inband alarm – Alarm is indicated when the output is in the range from DigOutChAAImLow to DigOutChAAImHigh. 2: Outband alarm – Alarm is indicated when the output is outside the range DigOutChAAImLow and DigOutChAAImHigh.</p> <p>A raised alarm on channel A pulls the digital output labeled "Pulse Output 0" low when VersDigOutCh0Config is configured to 0 (off).</p>
0x6D38 [K03]	DigOutChAAImLow	FLOAT32	<p>Digital Output Channel A Alarm Low: Initial alarm low value for channel A see DigOutChAAImType (0x6D36). See DigOutCh0AImLow (0x6D20) for the unit specification. Will be used to set DigOutChAAImLowCurr to its initial value.</p>
0x6D3A [K04]	DigOutChAAImHigh	FLOAT32	<p>Digital Output Channel A Alarm High: Initial alarm high value for channel A, see DigOutChAAImType (0x6D36). See DigOutCh0AImLow (0x6D20) for the unit specification. Will be used to set DigOutChAAImHighCurr to its initial value.</p>

Address/ID	Abbreviation	Type	Full Name / Description
0x6D3C	DigOutChAAImLowCurr	FLOAT32	Current Digital Output Chanel A Alarm Low: Current alarm low value for channel A see DigOutChAAImType (0x6D36). See DigOutCh0AlmLow (0x6D20) for the unit specification. Will be initially set to DigOutChAAImLow (0x6D38). A write of a new value has an immediate effect.
0x6D3E	DigOutChAAImHighCurr	FLOAT32	Current Digital Output Chanel A Alarm High: Current alarm high value for channel A, see DigOutChAAImType (0x6D36). Must be a floating point value of 0.0 or higher. See DigOutCh0AlmLow (0x6D20) for the unit specification. Will be initially set to DigOutChAAImHigh (0x6D3A). A write of a new value has an immediate effect.
0x6E06 [S01]	VersDigOutCh1Config	UINT32	Versatile Digital Output Channel 1 Configuration Used to assign different functions to the pulse output. In simple pulse mode, Pulse1 and Pulse2 operate independently. In phase shift mode, Pulse1 and Pulse2 work together to produce the desired pulse output relationship. In phase shift mode, both outputs (Pulse1 & Pulse2) should be set to the same mode. 0: Pulse output is off. 1: Mass Flow – Simple Pulse, Forward Flow. 2: Volume Flow – Simple Pulse, Forward Flow. 3: Mass Flow – Pulse1 & Pulse2 90 Degrees phase shift. 4: Volume Flow – Pulse1 & Pulse2 90 Degrees phase shift. 5: Mass Flow – Simple Pulse, Reverse Flow. 6: Volume Flow – Simple Pulse, Reverse Flow. 7: Mass Flow Rate Fast Frequency Output. 8: Volumetric Flow Rate Fast Frequency Output. 9: Density Fast Frequency Output. 10: Mass Flow Rate Slow Frequency Output. 11: Volumetric Flow Rate Slow Frequency Output. 12: Density Slow Frequency Output. 13: Mass Flow Rate RHE Compatibility Mode Frequency Output. 14: Volumes Flow Rate RHE Compatibility Mode Frequency Output. 15: Mass Flow – Pulse1 & Pulse2 180 Degrees phase shift, Forward Flow. 16: Volume Flow – Pulse1 & Pulse2 180 Degrees phase shift, Forward Flow. 17: Mass Flow – Pulse1 & Pulse2 180 Degrees phase shift, Reverse Flow. 18: Volume Flow – Pulse1 & Pulse2 180 Degrees phase shift, Reverse Flow.

Address/ID	Abbreviation	Type	Full Name / Description
0x6E08 [S02]	VersDigOutCh1PIsMass	FLOAT32	Versatile Digital Output Channel 1 Pulse Mass: Channel 1 pulse rate specification when VersDigCh1Config equals 1, 3, or 5. The value specifies the mass which shall be equivalent to one pulse. The unit is converted and displayed with the current mass unit setting in MassUnit (0x6104). Example: When set to 0.001kg (1 gram) a totalized mass transfer of 1kg will cause 1000 pulses to be outputted.
0x6E0A [S03]	VersDigOutCh1PIsVolume	FLOAT32	Versatile Digital Output Channel 1 Pulse Volume: Channel 1 pulse rate specification when VersDigCh1Config equals 2, 4, or 6. The value specifies the volume which shall be equivalent to one pulse. The unit is converted and displayed with the current volume unit setting in VolumeUnit (0x610C). Example: When set to 0.001m ³ (1 liter) a totalized volume transfer of 1m ³ will cause 1000 pulses to be outputted.
0x6E0C [S04]	VersDigOutCh1FreqMassFlwRt	FLOAT32	Versatile Digital Output Channel 1 Frequency Mass Flow Rate: Channel 1: Mass flow which corresponds to the reference frequency VersDigOutCh1FreqReference when VersDigCh1Config equals 7 or 10. The unit is converted and displayed with the current mass flow unit setting in VolumeFlowUnit (0x610A).
0x6E0E [S05]	VersDigOutCh1FreqVolFlwRt	FLOAT32	Versatile Digital Output Channel 1 Frequency Volumetric Flow Rate: Channel 1: Volume flow which corresponds to the reference frequency VersDigOutCh1FreqReference when VersDigCh1Config equals 8 or 11. The unit is converted and displayed with the current mass flow unit setting in MassFlowUnit (0x6106).
0x6E10 [S06]	VersDigOutCh1FreqDensity	FLOAT32	Versatile Digital Output Channel 1 Frequency Density: Channel 1: Density which corresponds to the reference frequency VersDigOutCh1FreqReference when VersDigCh1Config equals 9 or 12. The unit is converted and displayed with the current mass flow unit setting in DensityUnit (0x6108).
0x6E12 [S07]	VersDigOutCh1FreqReference	FLOAT32	Versatile Digital Output Channel 1 Frequency Reference: Channel 1: The reference frequency is the number of pulses per unit of the selected data source. The range is from 0.0 (invalid) to 10000.0. The default is 100.0.
0x6E14 [S08]	VersDigOutCh1NegateOutput	UINT32	Versatile Digital Output Channel 1 Inverse Pulses: Channel 1: Will cause the output of inverted pulses since Firmware Version 1.66. Following values are possible: 0 (default): positive/normal pulses. 1: inverted/negated pulses. 2: positive/normal pulses. 3: inverted/negated pulses.

Address/ID	Abbreviation	Type	Full Name / Description
0x6E16 [S09]	VersDigOutCh1MaxPulseWidth	UINT32	(Since V1.67) Versatile Digital Output Channel 1 Maximum Pulse Width: Maximum pulse width for pulse and frequency configurations in the range from 50 to 4000µs. A value below 50 specifies a 50% duty cycle of the outputted signal. Default is 0 and thus a 50% duty cycle is generated.
0x6E1C [J01]	DigOutCh1Config	UINT32	Digital Output Channel 1 Configuration: Alarm Channel 1 (DIR output) configuration: 0: Flow direction indication (default) 1: Mass flow alarm 2: Volumetric flow alarm 3: Density alarm 4: Tube temperature alarm 5: Torsion bar temperature alarm 6: Pressure 7: Forward Mass Totalizer TotalMassFwd (0x4B00) for Batch Mode 8: Forward Volume Totalizer TotalVolFwd (0x4B02) for Batch Mode 9: Fatal errors or Zeroing force output low, else high. 10: Fatal errors or Zeroing force output high, else low. 11: Assurance Factor Alarm. For the values 1 to 8 and 11 the “Pulse Output 1” is pulled low when the alarm condition specified in DigOutChBAlmType, DigOutChBAlmLow, and DigOutChBAlmHigh becomes true.
0x6E1E [J02]	DigOutCh1AlmType	UINT32	Digital Output Channel 1 Alarm Type: Alarm Channel 1 – Digital Alarm Type: 0: Setpoint alarm (hysteresis, default) – Alarm is indicated when the output is higher than DigOutCh1AlmHigh and cleared when it returns below DigOutCh1AlmLow. 1: Inband alarm – Alarm is indicated when the output is in the range from DigOutCh1AlmLow to DigOutCh1AlmHigh. 2: Outband alarm – Alarm is indicated when the output is outside the range DigOutCh1AlmLow and DigOutCh1AlmHigh. An indicated alarm on channel 1 pulls the digital output 3 labeled “DIR” low.
0x6E20 [J03]	DigOutCh1AlmLow	FLOAT32	Digital Output Channel 1 Alarm Low: Initial alarm low value for channel 1, see DigOutCh1AlmType (0x6E1E). See DigOutCh0AlmLow (0x6D20) for the unit specification. Will be used to set DigOutCh1AlmLowCurr to its initial value.

Address/ID	Abbreviation	Type	Full Name / Description
0x6E22 [J04]	DigOutCh1AlmHigh	FLOAT32	Digital Output Channel 1 Alarm High: Initial alarm high value for channel 1, see DigOutCh1AlmType (0x6E1E). See DigOutCh0AlmLow (0x6D20) for the unit specification. Will be used to set DigOutCh1AlmLowCurr to its initial value.
0x6E24	DigOutCh1AlmLowCurr	FLOAT32	Current Digital Output Channel 1 Alarm Low: Current alarm low value for channel 1 see DigOutCh1AlmType (0x6E1E). See DigOutCh0AlmLow (0x6D20) for the unit specification. Will be initially set to DigOutCh1AlmLow (0x6E20). A write of a new value has an immediate effect.
0x6E26	DigOutCh1AlmHighCurr	FLOAT32	Current Digital Output Channel 1 Alarm High: Current alarm high value for channel 1, see DigOutCh1AlmType (0x6D20). See DigOutCh0AlmLow (0x6D20) for the unit specification. Will be initially set to DigOutCh1AlmHigh (0x6E22). A write of a new value has an immediate effect.
0x6E34 [L01]	DigOutChBConfig	UINT32	Digital Output Channel B Configuration: Alarm Channel B configuration: 0: Flow direction indication (default) 1: Mass flow alarm 2: Volumetric flow alarm 3: Density alarm 4: Tube temperature alarm 5: Torsion bar temperature alarm 6: Pressure 7: Forward Mass Totalizer TotalMassFwd (0x4B00) for Batch Mode 8: Forward Volume Totalizer TotalVolFwd (0x4B02) for Batch Mode 9: Fatal errors or Zeroing force output low, else high. 10: Fatal errors or Zeroing force output high, else low. 11: Assurance Factor Alarm. For the values 1 to 8 and 11 the "Pulse Output 1" is pulled low when the alarm condition specified in DigOutChBAlmType, DigOutChBAlmLow, and DigOutChBAlmHigh becomes true.

Address/ID	Abbreviation	Type	Full Name / Description
0x6E36 [L02]	DigOutChBAImType	UINT32	<p>Digital Output Channel B Alarm Type: Alarm Channel B: Digital Alarm Type:</p> <p>0: Setpoint alarm (hysteresis, default) – Alarm is indicated when the output is higher than DigOutChBAImHigh and cleared when it returns below DigOutChBAImLow.</p> <p>1: Inband alarm – Alarm is indicated when the output is in the range from DigOutChBAImLow to DigOutChBAImHigh.</p> <p>2: Outband alarm – Alarm is indicated when the output is outside the range DigOutChBAImLow and DigOutChBAImHigh.</p> <p>A raised alarm on channel B pulls the digital output labeled “Pulse Output 2” low when VersDigOutCh1Config is configured to 0 (off).</p>
0x6E38 [L03]	DigOutChBAImLow	FLOAT32	<p>Digital Output Channel B Alarm Low: Initial alarm low value for channel B see DigOutChBAImType (0x6E36). See DigOutCh0AlmLow (0x6D20) for the unit specification. Will be used to set DigOutChBAImLowCurr to its initial value.</p>
0x6E3A [L04]	DigOutChBAImHigh	FLOAT32	<p>Digital Output Channel B Alarm High: Initial alarm high value for channel B, see DigOutChBAImType (0x6E36). See DigOutCh0AlmLow (0x6D20) for the unit specification. Will be used to set DigOutChBAImHighCurr to its initial value.</p>
0x6E3C	DigOutChBAImLowCurr	FLOAT32	<p>Current Digital Output Channel B Alarm Low: Current alarm low value for channel B see DigOutChBAImType (0x6E36). See DigOutCh0AlmLow (0x6D20) for the unit specification. Will be initially set to DigOutChBAImLow (0x6E38). A write of a new value has an immediate effect.</p>
0x6E3E	DigOutChBAImHighCurr	FLOAT32	<p>Current Digital Output Channel B Alarm High: Current alarm high value for channel B, see DigOutChBAImType (0x6E36). See DigOutCh0AlmLow (0x6D20) for the unit specification. Will be initially set to DigOutChBAImHigh (0x6E3A). A write of a new value has an immediate effect.</p>

D.14.1.2 Versatile Digital Output – MODBUS Holding Registers, SERVICE Level

Address/ID	Abbreviation	Type	Full Name / Description
0x6D00 [r01]	VersDigOutCh0MaxPulse	UINT32	<p>Versatile Digital Output Channel 0 Maximum Pulse: Channel 0 maximum amount of pulses in a 10ms cycle in the range of 0 to 100. Default is 100. This corresponds to 10000 pulses per second. When this register contains the value 0, a special slow pulse mode is selected for the pulse modes 1, 2, 5, 6, 15, 16, 17, and 18 in VersDigOutCh0Config (0x6D06) and the maximum pulse rate is limited to 50Hz. Otherwise the value 0 is interpreted as the maximum pulse rate of 10000 pulses per second.</p>

Address/ID	Abbreviation	Type	Full Name / Description
0x6D02	VersDigOutCh0TestStart	UINT32	Versatile Digital Output Channel 0 Test Start: Test control parameter for the channel 0 digital outputs: 0: Normal operation. 1: Depending on VersDigOutCh0Config (0x6D06) either a number of pulses in VersDigOutCh0TestValue (0x6D04) in 10ms time spans (1 results in 100Hz) is output or the value specifies a frequency in Hz. 2: Set the digital output 4 (ERR) to the value specified in VersDigOutCh0TestValue (0x6D04).
0x6D04	VersDigOutCh0TestValue	UINT32	Versatile Digital Output Channel 0 Test Value: Number of test pulses to be output on channel 0 in a 10ms time span when VersDigOutCh0TestStart is set to 1. For the Slow Pulse Mode this number specifies the number of edges in a second to output. There will be a maximum of one edge in 10ms.
0x6D18	DigOutCh0TestStart	UINT32	Digital Output Channel 0 Test Start: Alarm Channel 0 (ERR output) test operation: 0: Normal operation as alarm output. 1: Test operation – the setting in DigOutCh0TestValue is sent the ERR output. A 1 in this register will pull the output low, a 0 sets it high.
0x6D1A	DigOutCh0TestValue	UINT32	Digital Output Channel 0 Test Value: Alarm Channel 0 digital output test value used when DigOutCh0TestStart is set to 1. Must be set to 0 or 1.
0x6D30	DigOutChATestStart	UINT32	Digital Output Channel A Test Start: Alarm Channel A test operation: 0: Normal operation as alarm output. 1: Test operation – the setting in DigOutChATestValue is sent to the pulse output 1. A 1 in this register will pull the output low, a 0 sets it high.
0x6D32	DigOutChATestValue	UINT32	Digital Output Channel A Test Value: Alarm Channel A digital output test value used when DigOutChATestStart is set to 1. Must be set to 0 or 1.
0x6E00 [s01]	VersDigOutCh1MaxPulse	UINT32	Versatile Digital Output Channel 1 Maximum Pulse: Channel 1 maximum amount of pulses in a 10ms cycle in the range of 0 to 100. Default is 100. This corresponds to 10000 pulses per second. When this register contains the value 0, a special slow pulse mode is selected for the pulse modes 1, 2, 5, and 6 in VersDigOutCh1Config (0x6E06) and the maximum pulse rate is limited to 50Hz. Otherwise the value 0 is interpreted as the maximum pulse rate of 10000 pulses per second.

Address/ID	Abbreviation	Type	Full Name / Description
0x6E02	VersDigOutCh1TestStart	UINT32	Versatile Digital Output Channel 1 Test Start: Test control parameter for the channel 1 digital outputs: 0: Normal operation. 1: Depending on VersDigOutCh1Config (0x6E06) either a number of pulses in VersDigOutCh1TestValue (0x6E04) in 10ms time spans (1 results in 100Hz) is output or the value specifies a frequency in Hz. 4: Set the digital output 3 (DIR) to the value specified in VersDigOutCh1TestValue (0x6E04).
0x6E04	VersDigOutCh1TestValue	UINT32	Versatile Digital Output Channel 1 Test Value: Number of test pulses to be output on channel 1 in a 10ms time span when VersDigOutCh1TestStart is set to 1. For the Slow Pulse Mode this number specifies the number of edges in a second to output. There will be a maximum of one edge in 10ms.
0x6E18	DigOutCh1TestStart	UINT32	Digital Output Channel 1 Test Start: Alarm Channel 1 (DIR output) test operation: 0: Normal operation as alarm output. 1: Test operation – the setting in DigOutCh1TestValue is sent the DIR output. A 1 in this register will pull the output low, a 0 sets it high.
0x6E1A	DigOutCh1TestValue	UINT32	Digital Output Channel 1 Test Value: Alarm Channel 1 digital output test value used when DigOutCh1TestStart is set to 1. Must be set to 0 or 1.
0x6E30	DigOutChBTestStart	UINT32	Digital Output Channel B Test Start: Alarm Channel B test operation: 0: Normal operation as alarm output. 1: Test operation – the setting in DigOutChBTestValue is sent to the pulse output 2. A 1 in this register will pull the output low, a 0 sets it high.
0x6E32	DigOutChBTestValue	UINT32	Digital Output Channel B Test Value: Alarm Channel B digital output test value used when DigOutChBTestStart is set to 1. Must be set to 0 or 1.

D.14.2 Versatile Digital Output – MODBUS Input Registers

D.14.2.1 Versatile Digital Output – MODBUS Input Registers, USER Level

Address	Abbreviation	Type	Full Name / Description
0x4D00	VersDigOutCh0Frequency	FLOAT32	Pulse Frequency of Channel 0: Current frequency of Channel 0 Pulse Output in kHz.

Address	Abbreviation	Type	Full Name / Description
0x4D02	VersDigOuCh0PulseCount	FLOAT32	Pulse Count of Channel 0: Number of pulses output on Channel 0 Pulse Output since the last totalizer reset or the last start of a test via VersDigOutCh0TestStart (0x6D02). Used for diagnostic and service purposes.
0x4D04	DigOut0State	UINT32	Digital Output 0 State: Commanded state of the digital output 0 labeled "4 / ERR".
0x4D06	DigOutAState	UINT32	Digital Output A State: Commanded state of the digital output B when the pulse output 0 is configured off (0).
0x4E00	VersDigOutCh1Frequency	FLOAT32	Pulse Frequency of Channel 1: Current frequency of Channel 1 Pulse Output in kHz.
0x4E02	VersDigOuCh1PulseCount	FLOAT32	Pulse Count of Channel 1: Number of pulses output on Channel 1 Pulse Output since the last totalizer reset or the last start of a test via VersDigOutCh1TestStart (0x6E02). Used for diagnostic and service purposes.
0x4E04	DigOut1State	UINT32	Digital Output 1 State: Commanded state of the digital output 1 labeled "3 / DIR".
0x4E06	DigOutBState	UINT32	Digital Output B State: Commanded state of the digital output B when the pulse output 1 is configured off (0).

D.15 HMI

The HMI elements of the RHE transmitter consists of

- three LED indicators,
- a display,
- three buttons,
- and two digital inputs (depending in the model).

The parameter set for these elements include a test feature and the possibility to configure the behavior of the Zero button. The status registers reflect the status of the Zero button (RHE16 only) and the digital inputs.

Any parameters that are used to start a test mode will take effect immediately when they are set. These parameters are not stored in the internal EEPROM and their setting will revert to the default values after a system reset or power cycle.

D.15.1 HMI – MODBUS Holding Registers

D.15.1.1 HMI – MODBUS Holding Registers, USER Level

Address/ID	Abbreviation	Type	Full Name / Description
0x6F06 [H01]	TimeOut	UINT32	<p>Time Out for Zero Button: Delay time before pressing the Zero button starts the Zeroing Process in 50ms units. Range is 0 to 200. Default is 40 (2s). Not used for RHE20 type transmitters.</p>
0x6FOA [H02]	DI1Property	UINT32	<p>Property of Digital Input 1: Functionality of Digital Input 1:</p> <ul style="list-style-type: none"> 0: DI1 is disabled. All inputs are ignored (default). 1: DI1 causes the start of a Zeroing Process. Logic is positive – a transition to a high logic level starts the Zeroing. 2: Start Zeroing: Same as 1 but with inverted DI1 polarity. 3: DI1 causes reset of the Totalizers and the start of Batch Processing if configured, see Batch Mode (0x6F0E). Logic is positive – a transition to a high logic level starts the Batch. This also undoes the effects of the Batch Hold command, see values 9 and 10. 4: Reset Totalizers: Same as 3 but with inverted DI1 polarity. 5: A transition from low to high at DI1 stops the totalizers when they are in the running state. A transition from high to low at DI1 restarts the totalizers when they are in the stopped state. 6: Totalizers Stop/Start: Same as 3 but with inverted DI1 polarity. 7: Special functionality 1 started by transition from low to high and stopped at a transition from high to low. See extra document 8.2.1.11. 8: Special functionality 1: Same as 7 but with inverted DI1 polarity. 9: Batch Hold/Alarm override: a transition from low to high inverts all DOs which are configured for batch mode (DigOutChXConfig is 7 or 8 and DigOutChXAlmType is 1 or 2) and their upper alarm limit is not yet reached. This can be used to close the valves attached to the digital outputs. This is compatible to the RHE07 Batch Stop function. 10: Batch Hold/Alarm override: Same as 9 but with inverted DI1 polarity. 11: Batch Restart: a transition from low to high resets the alarm override for all DOs which are configured for batch mode (DigOutChXConfig is 7 or 8 and DigOutChXAlmType is 1 or 2). The totalizers are reset as well, when the batch filling limit has been surpassed as functions 3 and 4. This is compatible to the RHE07/08/11 Batch Start function. 12: Batch Restart: Same as 11 but with inverted DI1 polarity. 13: DI1 causes a reset&hold of the Totalizers. Logic is positive - a transition to a high logic level resets and stops the Totalizers. 14: Totalizers Reset&Hold: Same as 13 but with inverted DI1 polarity.

Address/ID	Abbreviation	Type	Full Name / Description
0x6FOC [H03]	DI2Property	UINT32	<p>Property of Digital Input 2: Functionality of Digital Input 2:</p> <ul style="list-style-type: none"> 0: DI2 is disabled. All inputs are ignored (default). 1: DI2 causes the start of a Zeroing Process. Logic is positive – a transition to a high logic level starts the Zeroing. 2: Start Zeroing: Same as 1 but with inverted DI2 polarity. 3: DI2causes reset of the Totalizers and the start of Batch Processing if configured, see Batch Mode (0x6FOE). Logic is positive – a transition to a high logic level starts the Batch. This also undoes the effects of the Batch Hold command, see values 9 and 10. 4: Reset Totalizers: Same as 3 but with inverted DI2 polarity. 5: A transition from low to high at DI2 stops the totalizers when they are in the running state. A transition from high to low at DI2 restarts the totalizers when they are in the stopped state. 6: Totalizers Stop/Start: Same as 3 but with inverted DI2 polarity. 7: Special functionality 1 started by transition from low to high and stopped at a transition from high to low. See extra document 8.2.1.11. 8: Special functionality 1: Same as 7 but with inverted DI2 polarity. 9: Batch Hold/Alarm override: a transition from low to high inverts all DOs which are configured for batch mode (DigOutChXConfig is 7 or 8 and DigOutChXAlmType is 1 or 2) and their upper alarm limit is not yet reached. This can be used to close the valves attached to the digital outputs. This is compatible to the RHE07 Batch Stop function. 10: Batch Hold/Alarm override: Same as 9 but with inverted DI2 polarity. 11: Batch Restart: a transition from low to high resets the alarm override for all DOs which are configured for batch mode (DigOutChXConfig is 7 or 8 and DigOutChXAlmType is 1 or 2). The totalizers are reset as well, when the batch filling limit has been surpassed as functions 3 and 4. This is compatible to the RHE07/08/11 Batch Start function. 12: Batch Restart: Same as 11 but with inverted DI2 polarity. 13: DI2 causes a reset&hold of the Totalizers. Logic is positive - a transition to a high logic level resets and stops the Totalizers. 14: Totalizers Reset&Hold: Same as 13 but with inverted DI2 polarity.

Address/ID	Abbreviation	Type	Full Name / Description
0x6F0E [H04]	BatchMode	UINT32	<p>Mode of Batch Processing: Batch Mode:</p> <p>0: Fixed Batch Control (Mass controlled). Behavior depends solely on the configuration of the Dis (Properties 0x6F0A and 0x6F0C) and Dos (DigOutChXConfig 0x6D1C, 0x6D34, 0x6E1C, 0x6E34, and the DigOutChXAlmType 0x6D1E, 0x6D36, 0x6E1E, 0x6E36 and the respective limits.).</p> <p>1: Fixed Batch Control (Volume controlled). Works identical to 0.</p> <p>2: Automatic Batch Mode via Forward Mass Totalizer. The transmitter automatically adjusts the control of the digital output channel 1 (DIR, DO3) to the target mass total specified in register BatchTargetMass (0x6F10). The parameter DigOutCh1Config (0x6E1C) must be set to 7 (Mass Total). Otherwise a batch mode configuration error is signaled in bit 12 of the ErrorStatus (0x401A) register. The parameter DigOutCh1AlmType (0x6E1E) controls the polarity of the output DIR/DO3. Other digital output channels may be configured to control a course mass flow which is taken into account by the automatic batch control, but the correct configuration of these outputs is the responsibility of the user.</p> <p>3: Automatic Batch Mode via Forward Volume Totalizer. The transmitter automatically adjusts the control of the digital output channel 1 (DIR/DO3) to the target volume total specified in register BatchTargetVol (0x6F12). The parameter DigOutCh1Config (0x6E1C) must be set to 8 (Volume Total). Otherwise a batch mode configuration error is signaled in bit 12 of the ErrorStatus (0x401A) register. The parameter DigOutCh1AlmType (0x6E13) controls the polarity of the output DIR/DO3. Other digital output channels may be configured to control a course volume flow which is taken into account by the automatic batch control, but the correct configuration of these outputs is the responsibility of the user.</p> <p>4: Same as 0. 5: Same as 1. 6: Same as 2. 7: Same as 3.</p>
0x6F10 [H05]	BatchTargetMass	FLOAT32	<p>Batch Target Mass: Target Mass for the automatic control of the Batch Mode 2. Default is 1kg. This value is converted according to the MassUnit (0x6104) unit conversion specification.</p>
0x6F12 [H06]	BatchTargetVol	FLOAT32	<p>Batch Target Volume: Target Volume for the automatic control of the Batch Mode 3. Default is 0.001 m³. This value is converted according to the VolumeUnit (0x610C) unit conversion specification.</p>
0x6F14 [H07]	BatchControlRange	FLOAT32	<p>Batch Control Loop Parameter: Specifies the target range in which the automatic batch control algorithm switches from a coarse approximation to a fine control loop and vice-versa. This parameter is specified in percent. The default is 0.5%.</p>

Address/ID	Abbreviation	Type	Full Name / Description
0x6F16 [H08]	DisplayLEDDisplayTimeout	INT32	Display LED Timeout: Specifies the time in seconds without user button activity after which the background LED display is switched off. The value 0 forces the background LEDs of display to be always on. The value -1 switches the backlight on as long as a mass flow greater than the cutoff limit is present and the timeout for button inputs is set to fixed 60 seconds. Default is 120 seconds.
0x6F18 [H09]	ButtonInactiveTime	UINT32	Inputs Inactive Timeout: Specifies the time in seconds without user button activity after which the display contents is changed to the default screen. The value 0 disables the return to the default screen. The range is from 0 to 600 seconds. Default is 120 seconds.
0x6F1A [H10]	DefaultScreen	UINT32	Default Screen Contents: Specifies the contents of the display when no input occurs for ButtonInactiveTime (0x6F18) seconds: 0: Mass Flow Presentation Screen (default) 1: Volume Flow Presentation Screen 2: Mass Net Total Presentation Screen 3: Volume Net Total Presentation Screen 4: Density Presentation Screen 5: Custody View. 6: Toggle Presentation Screens 0 to 5 every 20s. 7: Batch Mode Screen
0x6F1C	Squawk	UINT32	Identify Transmitter: Will invert the backlight LEDs of the display for the time specified span in units of 10ms in the range of 0 to 500 (5000ms). This can be used to identify a specific device attached to a multi-drop communication interface.
0x6F1E [H11]	HMIBackgroundLEDs	UINT32	Display Background LED Control: Controls the behavior of the Background LEDs: 0: Use codes similar to the definition of the Namur standard: Red for "Severe Error", blue for "Maintenance Required" due to configuration errors, yellow/orange for "Range Exceedance" either of the maximum ratings or of the user defined warning limits. White or off when no problem is found. 1: Do not use color codes. This will show a white backlight when input buttons are pressed and switch off the backlight after a period of inactivity. 2: Use the Assurance Factor (0x4026) as control for the backlight display: Red when it gets smaller than 20%, Violet from 20 to 50%, Yellow for 50 to 70% and White/off for greater than 70%. This feature only makes sense when AssurancePresent (0x6090) is non-zero.

Address/ID	Abbreviation	Type	Full Name / Description
0x6F22	BatchCommand	UINT32	<p>Batch Command: (Since Release 2.06) Allows the execution of batch-related which usually are executed via the Digital Inputs. Any write to this field has an immediate effect. This function is disabled when bit 1 of register CustodyLockProperty (0x6F08) is 0 and the Custody/Hard Lock switch is active, i.e. Totalizer Resets are forbidden. This register is automatically reset to 0 when the command was executed.</p> <p>0: No operation / Idle. 1: Batch Restart: This is the RHE07 compatible Batch Start command. It opens the valves by undoing the DO override caused by a Batch Hold command. It also conditionally resets the totalizers if the last filling has being concluded. See also functions 11 and 12 in the DIXProperty registers (0x6FOA and 0x6FOC). 2: Batch Hold: This overrides the DOs to close the valves which are configured for batch mode (DigOutChXConfig is 7 or 8 and DigOutChXAlmType is 1 or 2) and their upper alarm limit is not yet reached. This is compatible to the RHE07 Batch Stop command. The totalizers are not affected. See also functions 9 and 10 in the DIXProperty registers (0x6FOA and 0x6FOC). 3: Batch Reset: Resets the totalizers and terminates the DO overrides caused by command 2 and effectively forces a start of a new filling. See also functions 3 and 4 in the DIXProperty registers (0x6FOA and 0x6FOC).</p>
0x6F36	FillingReactionTime	FLOAT32	<p>Reaction Time for Filling: Initial value for FillingReactionTimeCurr (0x6F38). This specifies the reaction time of the filling system, i.e. in most cases the closure time of a valve, in seconds. Only positive values are allowed. The default is 0.0.</p>
0x6F38	FillingReactionTimeCurr	FLOAT32	<p>Current Reaction Time for Filling: Current value for the system reaction time. This specifies the reaction time of the filling system, i.e. in most cases the closure time of a valve, in seconds. Only positive values are allowed. Any change has an immediate effect. This value is used together with the current mass or volume flow to correct the timing of a digital output configured for batching (DigOutChXConfig is 7 or 8) by subtracting the mass or volume corresponding to the current flow from the upper limit (DigOutChXAlmHighCurr) configured in the DO setup parameters. Be aware that this correction is applied to all DOs configured for batching, for example both channels in a fine / coarse nozzle configuration.</p>

D.15.1.2 HMI – MODBUS Holding Registers, SERVICE Level

Address/ID	Abbreviation	Type	Full Name / Description
0x6F00	LEDsTestStart	UINT32	<p>LED Test Start: Commands starts the LED test: 0: Normal operation (default). 1: Set the LEDs in accordance with the value specified in LEDsTestValue (0x6F02). 2: Blink test for all three LEDs.</p>
0x6F02	LEDsTestValue	UINT32	<p>LED Test Values: The LEDs are tested when LEDsTestStart is set to 1. Each of the three LEDs is assigned a bit in this field. Field value range is from 0 to 7: Bit 0: Controls LED1 (red, failure indication). Bit 1: Controls LED2 (green, unit operational indication). Bit 2: Controls LED3 (yellow, flow direction). For the RHE transmitters which feature displays with white backgrounds the bits control the background LEDs red, green and blue.</p>
0x6F04 [h01]	LockUserInput	UINT32	<p>Lock User Zeroing Input: This parameter, when set, disables the Zero Button: 0: Zero button operates normally (default). 1: Zero button is disabled.</p>
0x6F08 [h02]	CustodyLockProperty	UINT32	<p>Property of the Custody Lock: Property of the Custody Lock: 0: Custody Lock prohibits Zeroing and Parameter Changes. 1: Zeroing allowed while Custody Lock is active. 2: Totalizer Reset is allowed while Custody Lock is active. 3: Zeroing and Totalizer Reset is allowed while Custody Lock is active. Default is 2.</p>
0x6F24 [h03]	DisableDefaultPasswords	UINT32	<p>Disables Default Passwords: (Since Release 2.07) When this register contains 1 the documented default service password and the user password in UserPassword (0x6004) cannot be used for login into the RHE. In this case only passwords derived from the serial number can be used. The default is 0 which enables the use of the default passwords.</p>

D.15.2 HMI – MODBUS Input Registers

D.15.2.1 HMI – MODBUS Input Registers, SERVICE Level

Address	Abbreviation	Type	Full Name / Description
0x4F00	PortMirror	UINT32	Button Input State: Mirrors the state of the Zero Button when the LEDsTestStart is set to 1. Used for diagnostic purposes.
0x4F02	DI1Mirror	UINT32	State of the Digital Input 1: Mirrors the state of the Digital Input 1. Used for diagnostic purposes.
0x4F04	DI2Mirror	UINT32	State of the Digital Input 2: Mirrors the state of the Digital Input 2. Used for diagnostic purposes.
0x4F06	CustodyHardErrorCount	UINT32	Custody Hard Error Count: (Since Release 2.03) Number of hardware related failures such as temperature sensor or mass flow (RHM) sensor failures. In order to support the system startup hardware failures in the first 100 seconds after power-up are not counted. This number usually will be non-zero when a new transmitter is delivered because the production process will generate several such errors. The hard error counter will stop counting at 32767.
0x4F08	CustodyRangeErrorCount	UINT32	Custody Range Error Count: (Since Release 2.03) Number of range errors where measurement results exceed the hardware ranges defined in the setup parameters. The range error counter will stop counting at 32767.
0x4F0A	CustodyZeroingCount	UINT32	Custody Zeroing Count: (Since Release 2.03) Number of zeroing procedures performed by the RHE transmitter. The zeroing counter will stop counting at 32767.
0x4F0C	CustodyLockCount	UINT32	Custody Lock Count: (Since Release 2.03) Number of changes of the hard lock (custody transfer) switch when the transmitter is ordered with the hard lock option. This number will be even when the lock switch is open and odd when the switch is closed. The zeroing counter will stop counting at 32767.
0x4F0E	BatchTotalSnapshot	FLOAT32	Totalizer Snapshot at Batch End: Snapshot of the forward totalizer (TotalMassFwd, 0x4B00) when a Digital Output configured for batching (DigOutChXConfig is 7 or 8 and DigOutChXAlmType is 1 or 2) transitions its state. This will freeze the state of the current forward totalizer at the moment when a valve is closed and may be used to observe the difference to the forward totalizer when the filling is concluded in order to obtain the transferred mass after the valve close command. Note that this snapshot also may happen when the totalizer is cleared and the digital output transitions its state again. This value is based on the unit specified in MassUnit holding register (0x6104).

Address	Abbreviation	Type	Full Name / Description
0x4F10	BatchMassFlowSnapshot	FLOAT32	<p>Mass Flow Snapshot at Batch End: Snapshot of the current mass flow (MassFlowRate, 0x4900) when a Digital Output configured for batching (DigOutChXConfig is 7 or 8 and DigOutChXAlmType is 1 or 2) transitions its state. This will freeze the current mass flow at the moment when a valve is closed and may be used to observe the difference to the forward totalizer when the filling is concluded in order to obtain the transferred mass after the valve close command. Note that this snapshot also may happen when the totalizer is cleared and the digital output transitions its state again. This value is based on the unit specified in MassFlowUnit holding register (0x6106).</p>

D.16 Fast Access Groups

The fast access groups combine the contents of registers of several groups into one MODBUS address range in order to provide fast access via multiple register reads. Basically one MODBUS read can transfer all relevant data in an industrial control environment from the RHE transmitter to a supervisory control system.

D.16.1 Fast Access to Combined Measurements

Address	Abbreviation	Type	Original Group Name / Address
0x5000	ErrorStatus	UINT32	See Generic / 0x401A.
0x5002	SoftError	UINT32	See Generic / 0x401C.
0x5004	Warnings	UINT32	See Generic / 0x401E.
0x5006	InfoStatus	UINT32	See Generic / 0x4020.
0x5008	DenComp	FLOAT32	See Density / 0x4806.
0x500A	MassFlowRate	FLOAT32	See Mass Flow / 0x4900.
0x500C	VolumetricFlowRate	FLOAT32	See Volumetric Flow / 0x4A00.
0x500E	TotalMassFwd	FLOAT32	See Totalizer / 0x4B00.
0x5010	TotalVolFwd	FLOAT32	See Totalizer / 0x4B02.
0x5012	TotInvenMassNet	FLOAT32	See Totalizer / 0x4B04.
0x5014	TotInvenVolNet	FLOAT32	See Totalizer / 0x4B06.
0x5016	TotalMassRev	FLOAT32	See Totalizer / 0x4B08.
0x5018	TotalVolRev	FLOAT32	See Totalizer / 0x4B0A.
0x501A	AdcTubeMeanTemp	FLOAT32	See Temperature Measurement / 0x4500.
0x501C	AdcTorBarMeanTemp	FLOAT32	See Temperature Measurement / 0x4502.
0x501E	OnBrdTemp	FLOAT32	See Temperature Measurement / 0x4504.
0x5020	PrsMean	FLOAT32	See Pressure / 0x4604.

Address	Abbreviation	Type	Original Group Name / Address
0x5022	AssuranceFactor	FLOAT32	See Generic / 0x4026.
0x5024	StdDensity	FLOAT32	See Density / 0x480A.
0x5026	VolPercentMainSubstance	FLOAT32	See Density/0x480C. (Since Release 1.76)
0x5028	MassFlowRateDisplay	FLOAT32	See Mass Flow/0x4904. (Since Release 1.76)
0x502A	VolFlowRateDisplay	FLOAT32	See Volume Flow/0x4A02. (Since Release 1.76)

D.16.2 Fast Access to Temperature Data

Address	Abbreviation	Type	Original Group Name / Address
0x5100	ErrorStatus	UINT32	See Generic / 0x401A.
0x5102	SoftError	UINT32	See Generic / 0x401C.
0x5104	Warnings	UINT32	See Generic / 0x401E.
0x5106	InfoStatus	UINT32	See Generic / 0x4020.
0x5108	AdcTubeMeanTemp	FLOAT32	See Temperature Measurement / 0x4500.
0x510A	AdcTorBarMeanTemp	FLOAT32	See Temperature Measurement / 0x4502.
0x510C	OnBrdTemp	FLOAT32	See Temperature Measurement / 0x4504.

D.16.3 Fast Access to Totalizer Data

Address	Abbreviation	Type	Original Group Name / Address
0x5200	ErrorStatus	UINT32	See Generic / 0x401A.
0x5202	SoftError	UINT32	See Generic / 0x401C.
0x5204	Warnings	UINT32	See Generic / 0x401E.
0x5206	InfoStatus	UINT32	See Generic / 0x4020.
0x5208	TotalMassFwd	FLOAT32	See Totalizer / 0x4B00.
0x520A	TotalVolFwd	FLOAT32	See Totalizer / 0x4B02.
0x520C	TotInvenMassNet	FLOAT32	See Totalizer / 0x4B04.
0x520E	TotInvenVolNet	FLOAT32	See Totalizer / 0x4B06.
0x5208	TotalMassRev	FLOAT32	See Totalizer / 0x4B08.
0x520A	TotalVolRev	FLOAT32	See Totalizer / 0x4B0A.



About Rheonik

Rheonik has but one single purpose: to design and manufacture the very best Coriolis meters available.

Our research and engineering resources are dedicated to finding new and better ways to provide cost effective accurate mass flow solutions that provide value to our customers. Our manufacturing group care for each and every meter we produce from raw materials all the way to shipping, and our service and support group are available to help you specify, integrate, start-up and maintain every Rheonik meter you have in service. Whether you own just one meter or have hundreds, you will never be just another customer to us. You are our valued business partner.

Need a specific configuration for your plant? Don't compromise with a "standard" product from elsewhere that will add extra cost to your installation. If we can't configure it from our extensive and versatile product range, our exclusive **AnyPipeFit Commitment** can have your flow sensor customized with any size/type of process connection and face to face dimension you need.

No matter what control system you use as the backbone in your enterprise, with our **AnyInterface Commitment**, you can be sure that connection and communication will not be a problem. Alongside a wide variety of discrete analog and digital signal connections, we can also provide just about any network/bus interface available (for example: HART, ProfibusDP, ProfiNet, EtherCAT, PowerLink, EtherNet/IP, CAN,) with our RHE 40 Series family of transmitters. Rheonik RHE 40 Series transmitters can connect to your system – no headache and no conversion needed.

Rheonik Messtechnik GmbH
Rudolf-Diesel-Straße 5
D-85235 Odelzhausen
Germany

Tel + 49 (0)8134 9341-0
info@rheonik.com

